

euro It

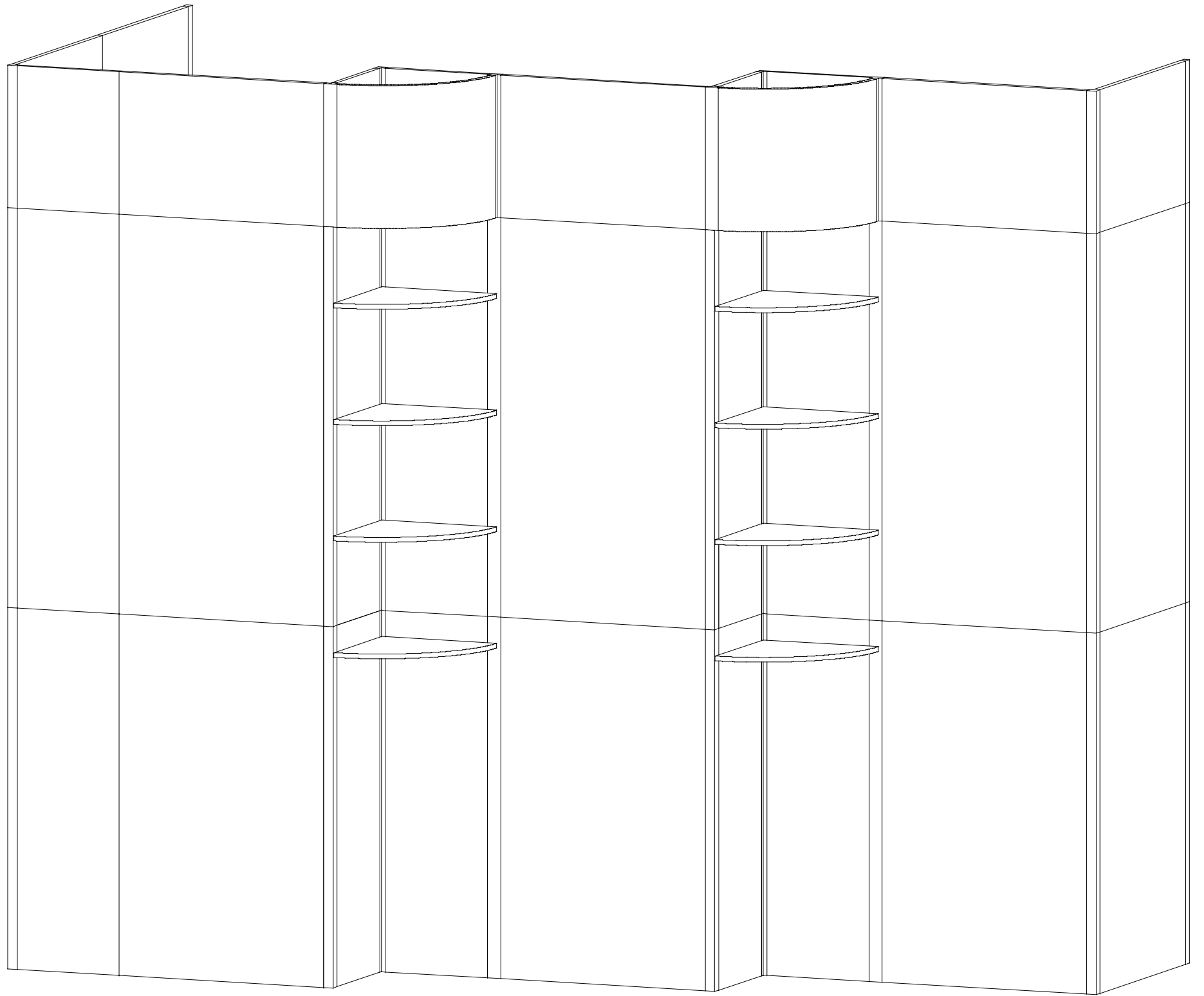
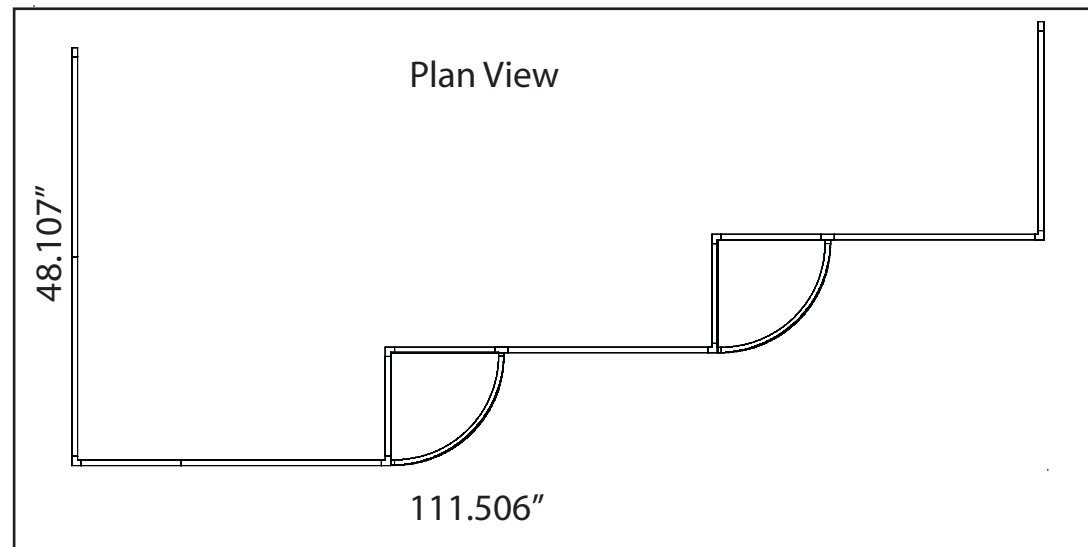

euro lt | HYBRIDS

Euro LT Hybrids General Setup Instructions

Using Your Setup Instructions

The Euro LT Hybrids Setup Instructions are created specifically for your configuration. They are laid out sequentially in levels, including exploded views, and a logical series of detailed steps to assemble the main structure and components. We encourage you to study the instructions **before** attempting to assemble your exhibit.

Cleaning and Packing Your Display

- 1) When cleaning laminate countertops or panels use mild cleansers and a soft material such as cotton.
- 2) Keep all display components away from extreme heat and long exposure to sunlight to avoid warping and fading.
- 3) Retain all packing material. It will make re-packing much easier and will reduce the likelihood of shipping damage.

Level 1 = Blue
 Level 2 = Red
 Level 3 = Green
 Level 4 = Black

Color Code

The top clip is color coded to distinguish the level. The color coded clip also contains the numbered label

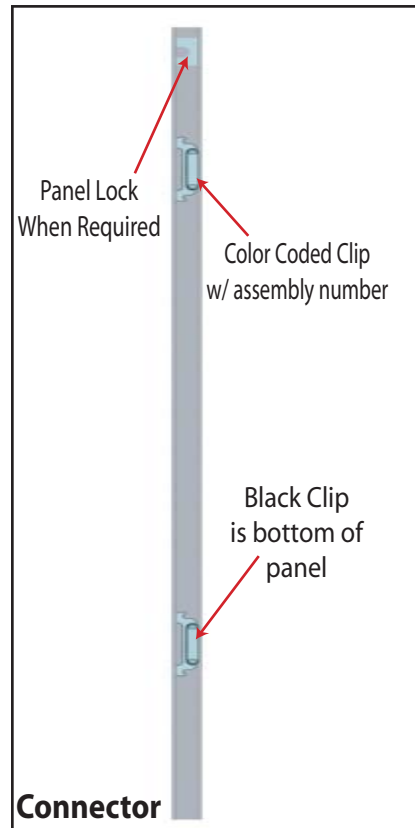

Each component has 2 clips, the lower clip is ALWAYS black..

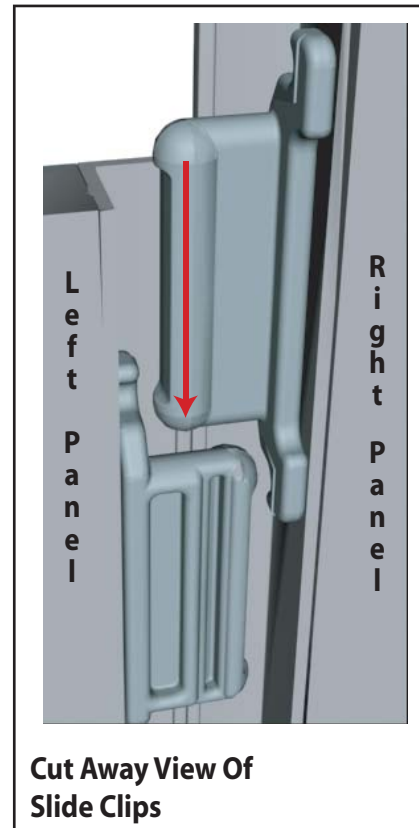

Components connect together by aligning them and sliding downward connecting clips together.

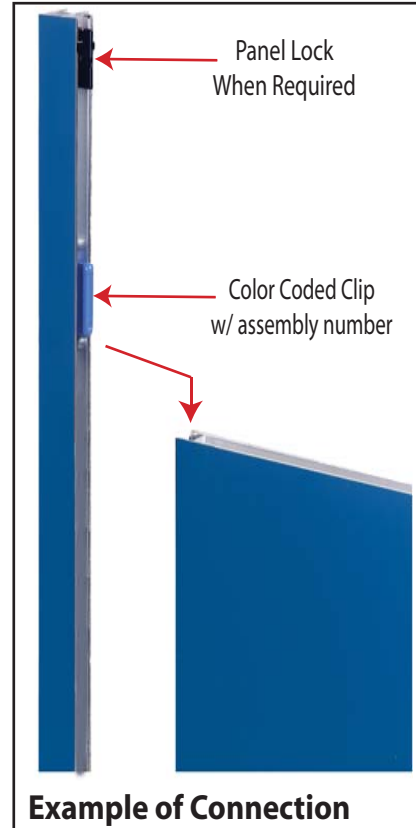

Configurations are assembled from left to right, usually starting with #1 and following the numbered sequence.

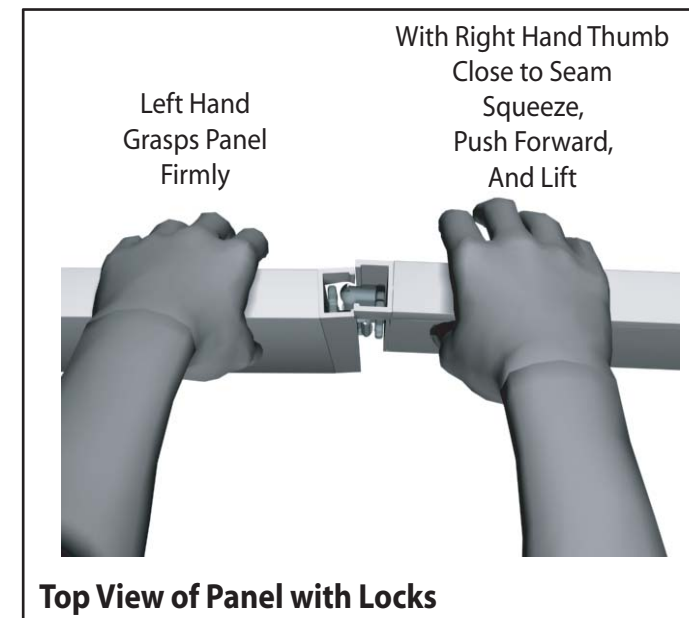

The first level of components contains panel locks that are located at the top of the panel for extra stability and a seamless connection. When disassembling panels, twist top connection slightly and lift right panel upward.

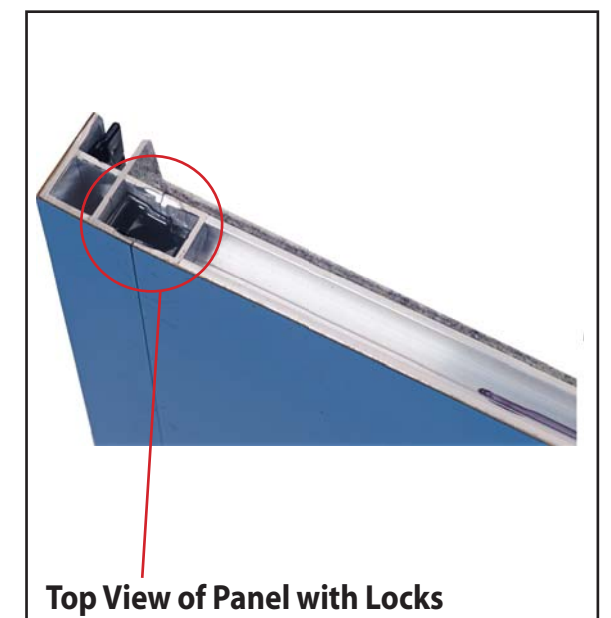

866.652.2100

Item Number	Description
1	38" h End Cap
2	23" w x 38" h Flat Panel
3	23" w x 38" h Flat Panel
4	38" h 90° Connector
5	11.5" w x 38" h Flat Panel
6	23" w x 38" h Flat Panel
7	38" h 90° Connector
8	11.5" w x 38" h Flat Panel
9	38" h 90° Connector
10	11.5" w x 38" h Flat Panel
11	38" h 180° Connector
12	23" w x 38" h Flat Panel
13	38" h 90° Connector
14	11.5" w x 38" h Flat Panel
15	38" h 90° Connector
16	11.5" w x 38" h Flat Panel
17	38" h 180° Connector
18	23" w x 38" h Flat Panel
19	38" h 90° Connector
20	23" w x 38" h Flat Panel
21	38" h End Cap

Steps:
Connect panels together in numerical order as shown in illustrations.

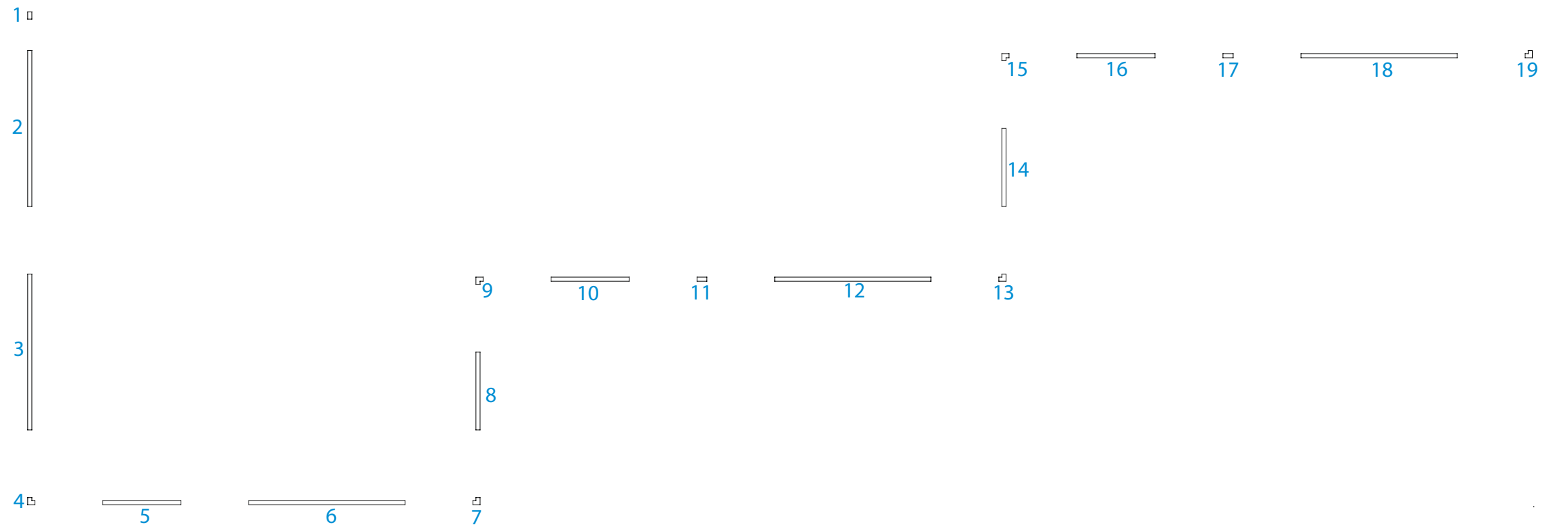
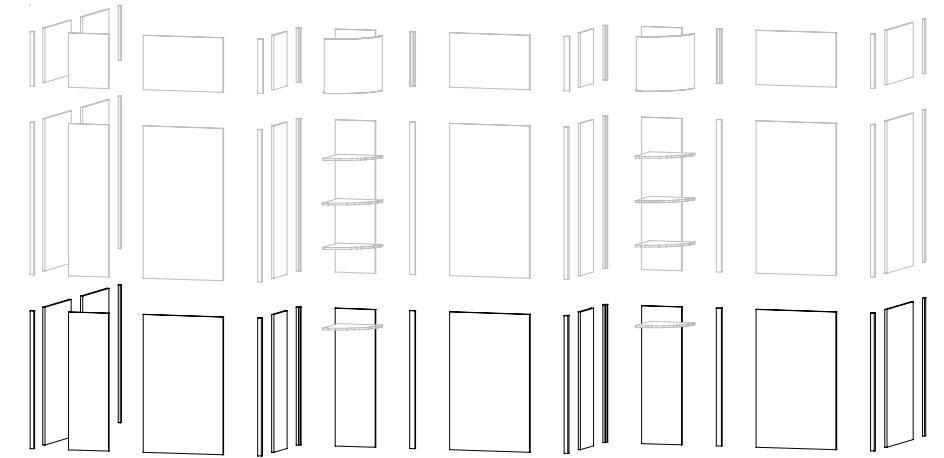

866.652.2100

Item Number	Description
1	42" h End Cap
2	23" w x 42" h Flat Panel
3	23" w x 42" h Flat Panel
4	42" h 90° Connector
5	11.5" w x 42" h Flat Panel
6	23" w x 42" h Flat Panel
7	42" h 90° Connector
8	11.5" w x 42" h Flat Panel
9	42" h 90° Connector
10	11.5" w x 42" h Flat Panel
11	42" h 180° Connector
12	23" w x 42" h Flat Panel
13	42" h 90° Connector
14	11.5" w x 42" h Flat Panel
15	42" h 90° Connector
16	11.5" w x 42" h Flat Panel
17	42" h 180° Connector
18	23" w x 42" h Flat Panel
19	42" h 90° Connector
20	23" w x 42" h Flat Panel
21	42" h End Cap

Steps:
Connect panels together in numerical order as shown in illustrations.

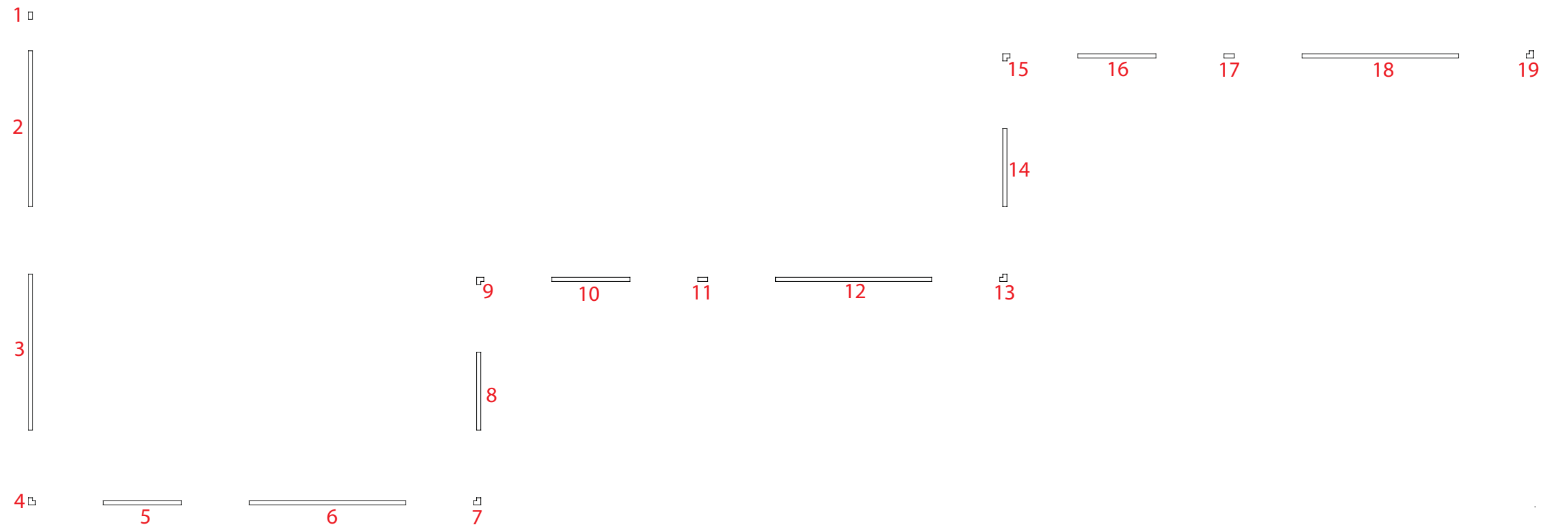
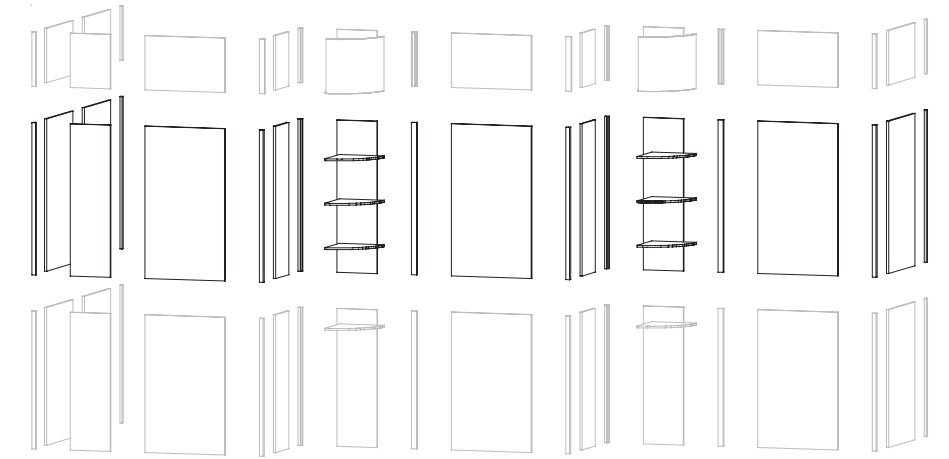

866.652.2100

Item Number	Description
1	15" h End Cap
2	23" w x 15" h Flat Panel
3	23" w x 15" h Flat Panel
4	15" h 90° Connector
5	11.5" w x 15" h Flat Panel
6	23" w x 15" h Flat Panel
7	15" h T-Connector
8	11.5" w x 15" h Flat Panel
9	15" h 90° Connector
10	11.5" w x 15" h Flat Panel
11	15" h T-Connector
12	23" w x 15" h Flat Panel
13	15" h T-Connector
14	11.5" w x 15" h Flat Panel
15	15" h 90° Connector
16	11.5" w x 15" h Flat Panel
17	15" h T-Connector
18	23" w x 15" h Flat Panel
19	15" h 90° Connector
20	23" w x 15" h Flat Panel
21	15" h End Cap

Item Number	Description
22	11.5" r x 15" h SconcePanel
23	11.5" r x 15" h SconcePanel

Steps:
Connect panels together in numerical order as shown in illustrations.

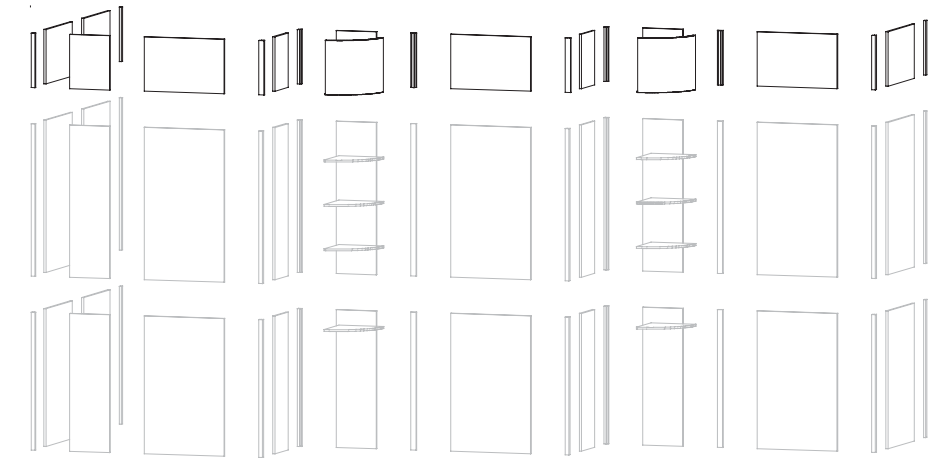

1 □



2



3



4 □



5



6

7



9



10

11



12

13



15



16

17



18

19



21



20

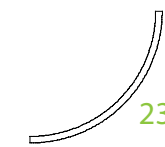

23

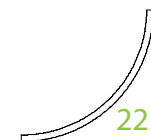

22

866.652.2100

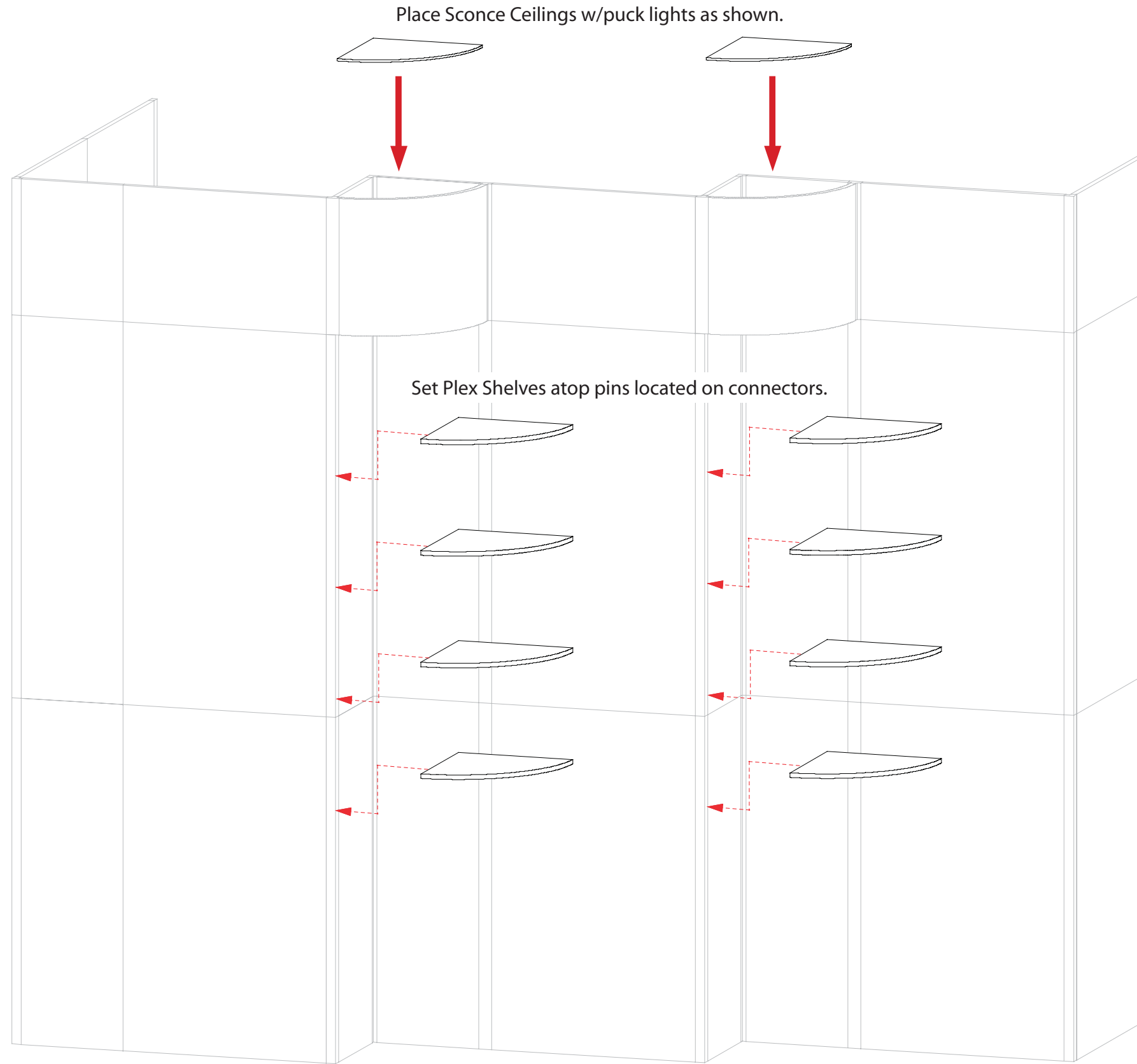

NOTE :

PDF copies of your Setup Instructions are available @ classicexhibits.com
See the search tool on the lower left hand corner of the Home page.

Enter the 5 digit Order #. Search for Setup Instructions