

# euro It

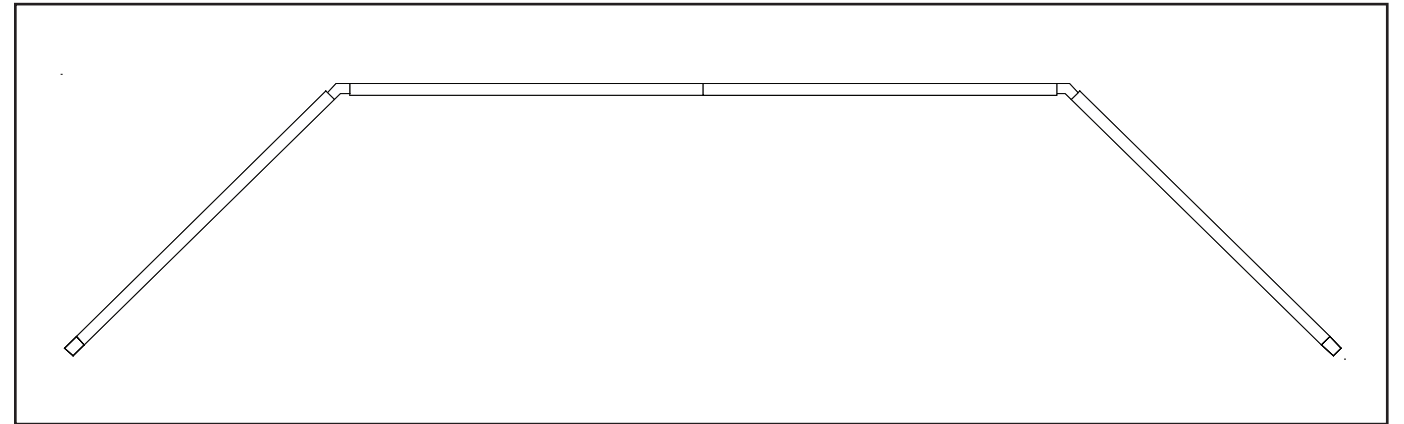
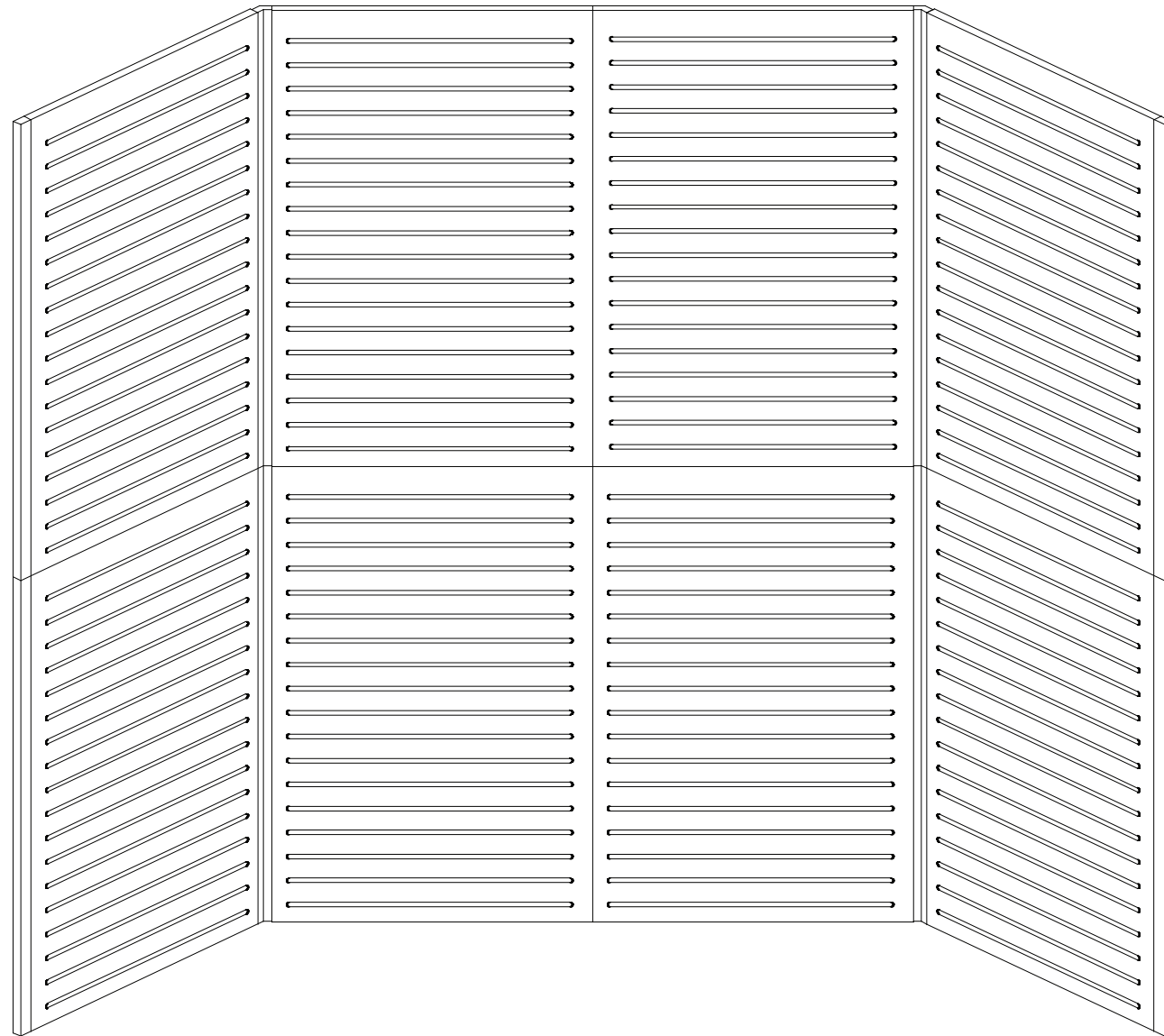

Plan View

# euro lt | HYBRIDS

## Euro LT Hybrids General Setup Instructions

### Using Your Setup Instructions

The Euro LT Hybrids Setup Instructions are created specifically for your configuration. They are laid out sequentially in levels, including exploded views, and a logical series of detailed steps to assemble the main structure and components. We encourage you to study the instructions **before** attempting to assemble your exhibit.

### Cleaning and Packing Your Display

- 1) When cleaning laminate countertops or panels use mild cleansers and a soft material such as cotton.
- 2) Keep all display components away from extreme heat and long exposure to sunlight to avoid warping and fading.
- 3) Retain all packing material. It will make re-packing much easier and will reduce the likelihood of shipping damage.

Level 1 = Blue  
 Level 2 = Red  
 Level 3 = Green  
 Level 4 = Black

#### Color Code

The top clip is color coded to distinguish the level. The color coded clip also contains the numbered label

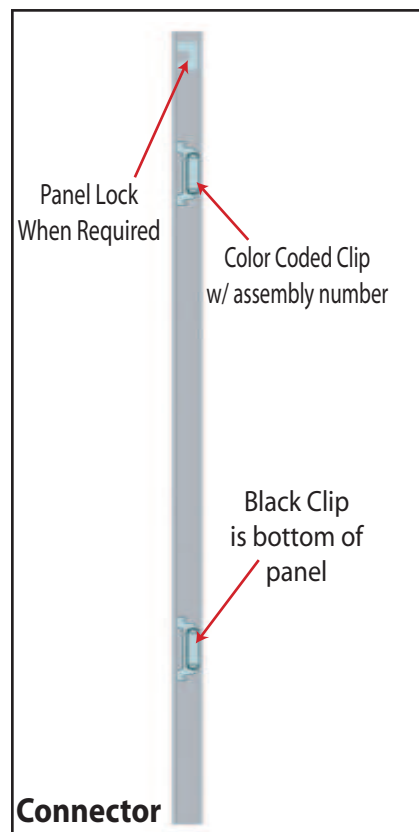

Each component has 2 clips, the lower clip is ALWAYS black..

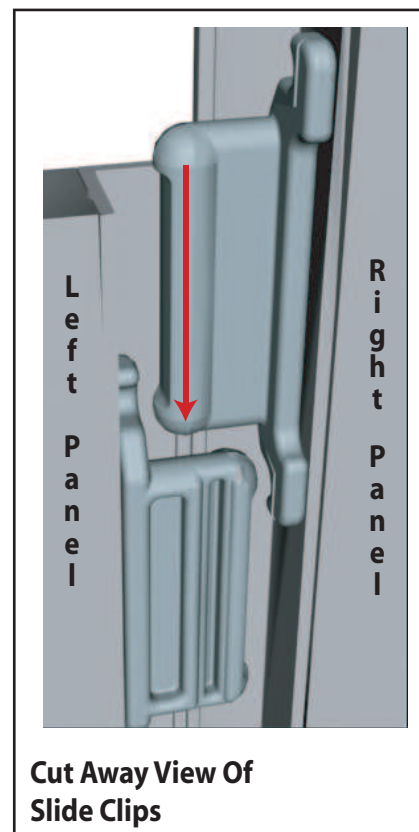

Components connect together by aligning them and sliding downward connecting clips together.

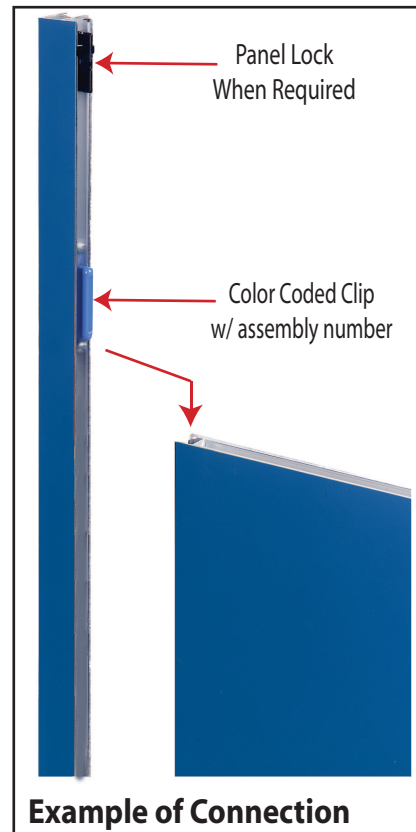

Configurations are assembled from left to right, usually starting with #1 and following the numbered sequence.

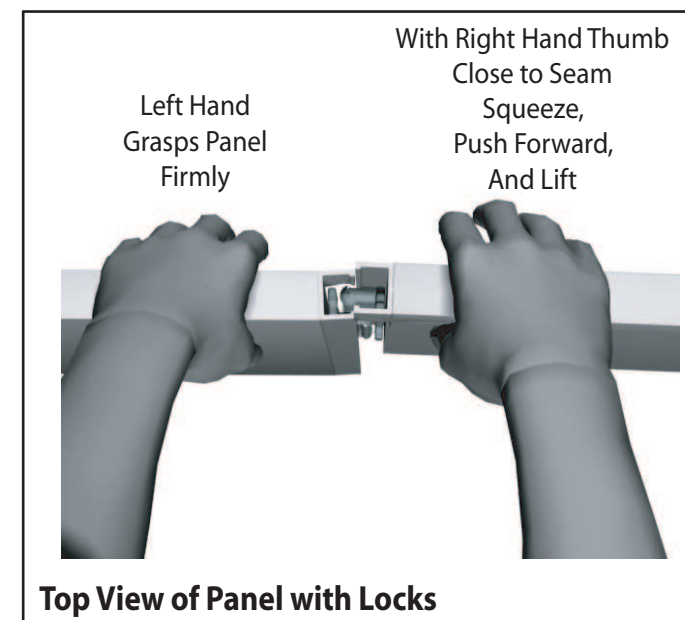

The first level of components contains panel locks that are located at the top of the panel for extra stability and a seamless connection. When disassembling panels, twist top connection slightly and lift right panel upward.

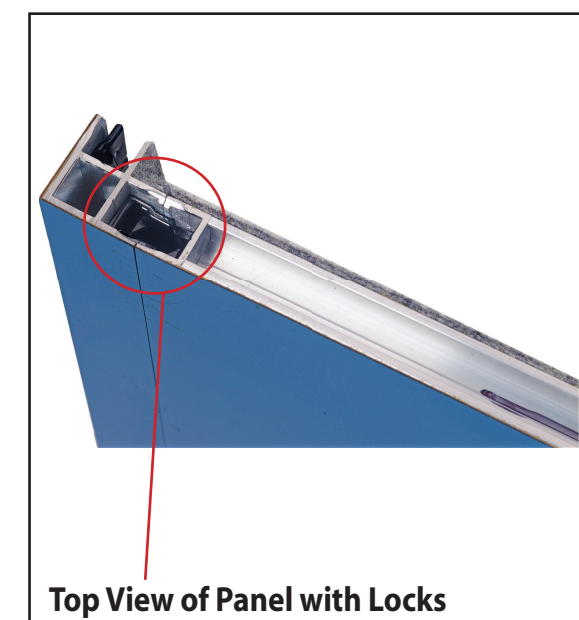

866.652.2100

Item Number	Description
1	38" h End Cap
2	23" w x 38" h Flat Panel w/ Slatwall
3	38" h 135° Connector
4	23" w x 38" h Flat Panel w/ Slatwall
5	23" w x 38" h Flat Panel w/ Slatwall
6	38" h 135° Connector
7	23" w x 38" h Flat Panel w/ Slatwall
8	38" h End Cap

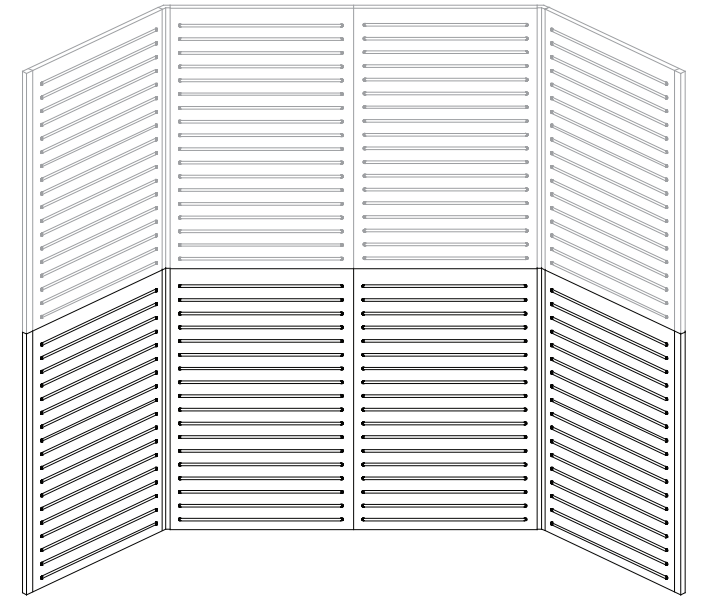

Steps:

- 1) Assemble by starting at panel #1 and continue in numerical order.

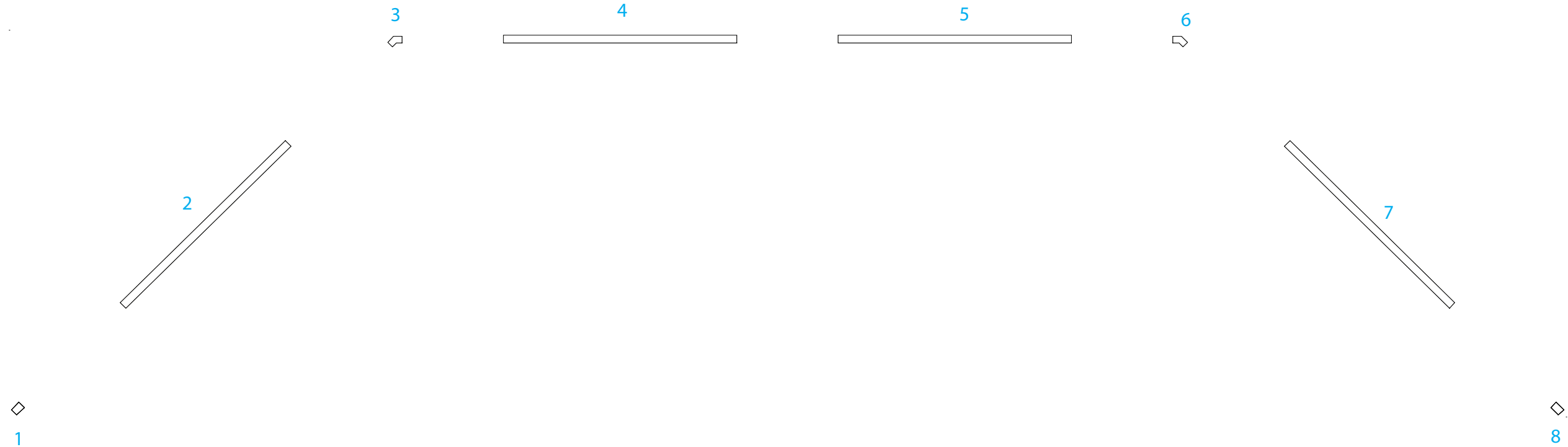

866.652.2100

Item Number	Description
1	38" h End Cap
2	23" w x 38" h Flat Panel w/ Slatwall
3	38" h 135° Connector
4	23" w x 38" h Flat Panel w/ Slatwall
5	23" w x 38" h Flat Panel w/ Slatwall
6	38" h 135° Connector
7	23" w x 38" h Flat Panel w/ Slatwall
8	38" h End Cap

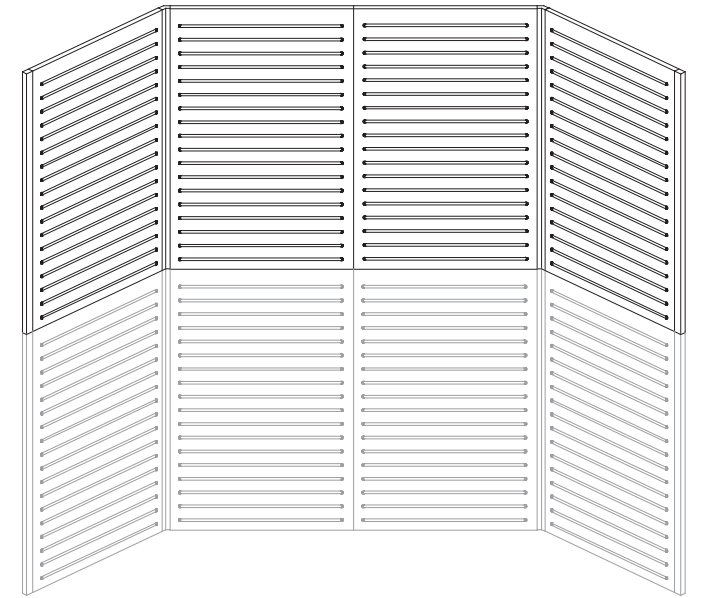

Steps:

- 1) Assemble by starting at panel #1 and continue in numerical order.

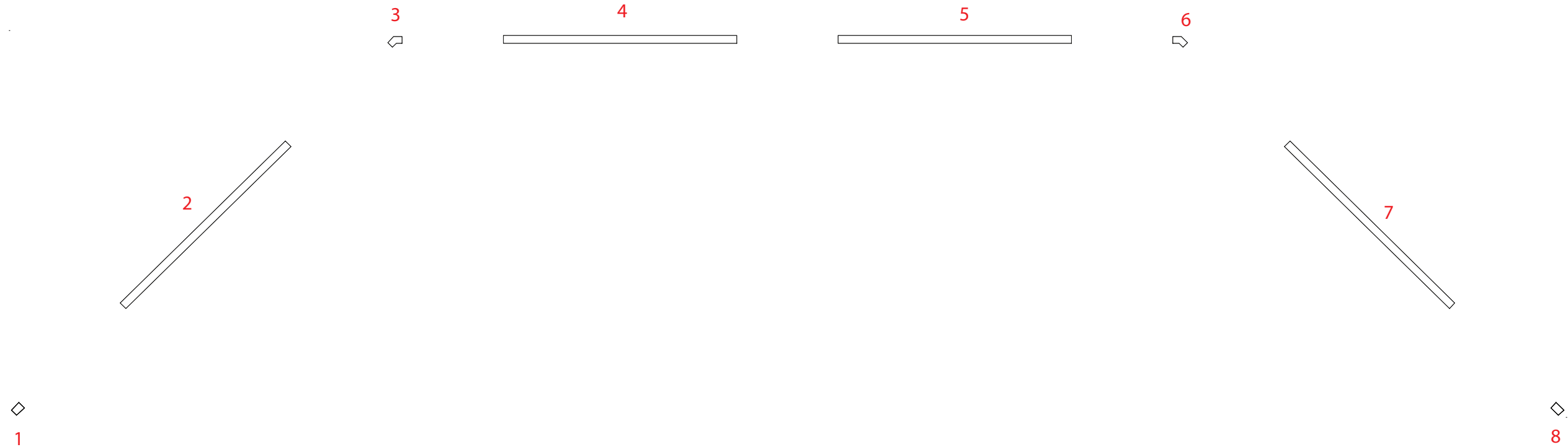

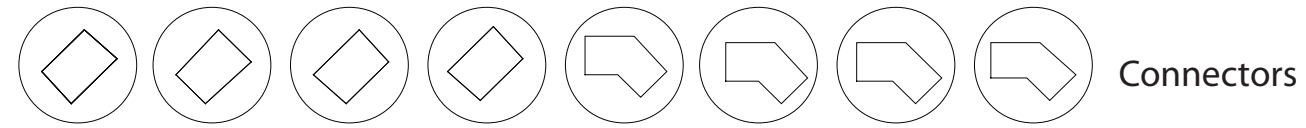

7
5
4
2
7
5
4
2

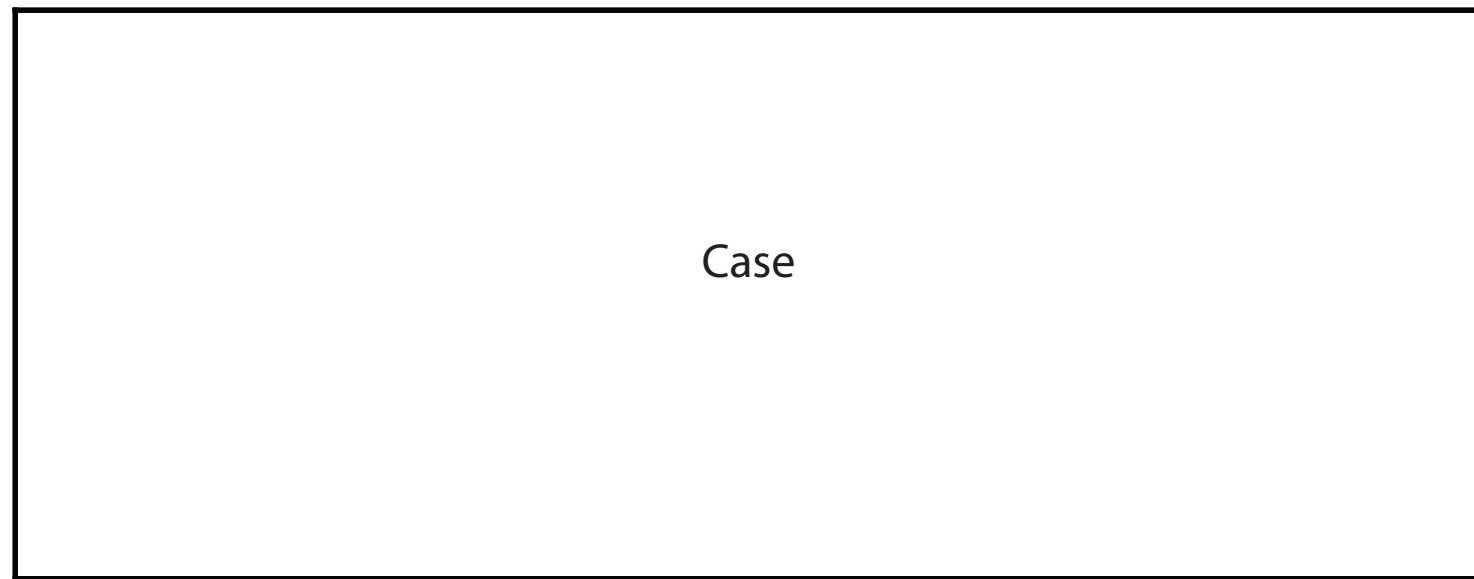

**NOTE :**

PDF copies of your Setup Instructions are available @ [classicexhibits.com](http://classicexhibits.com)  
See the search tool on the lower left hand corner of the Home page.

Enter the 5 digit Order #. Search for Setup Instructions