

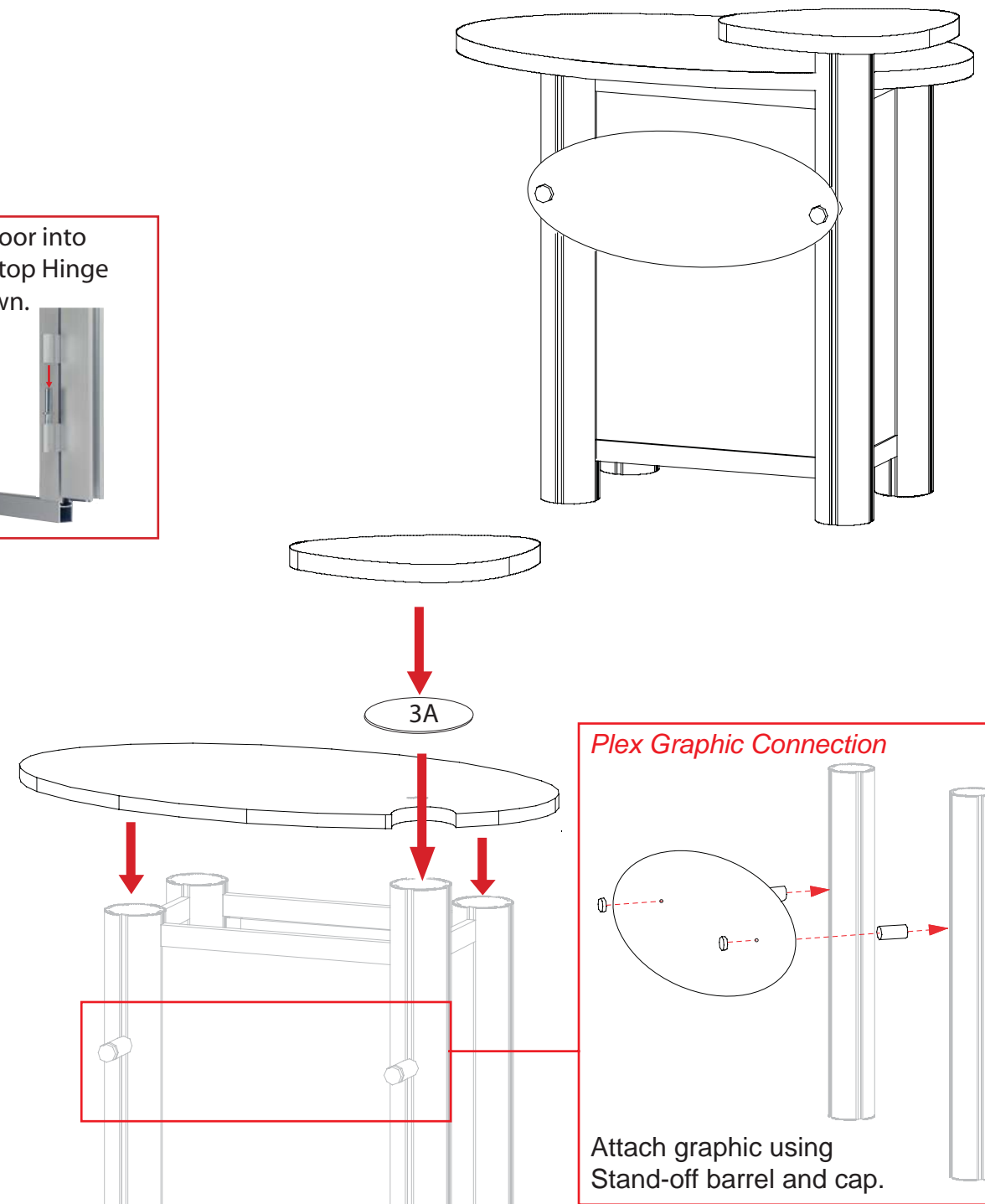

Item	Quantity	Description
1	1	38" h Vertical Extrusion
2	1	38" h Vertical Extrusion
3	1	42" h Vertical Extrusion
3A	1	Plate for Counter Connection
4	1	38" h Vertical Extrusion
5	2	20" w Horizontal Extrusion
6	2	8.5" w Horizontal Extrusion
7	2	20" w Horizontal Extrusion
8	2	8.5" w Horizontal Extrusion

Steps:

- 1) Connect horizontal extrusions [5 and 6] between vertical extrusions [1, 2, 3 and 4].
- 2) Set floor in place atop lip of horizontal extrusions.
- 3) Place doors and inserts in place as shown.
- 4) Connect horizontal extrusions [7, and 8] between vertical extrusions [1, 2, 3 and 4] and atop inserts and door.
- 5) Place counter atop assembled pedestal, attach [3A] to extrusion [3] then connect smaller counter to [3A].

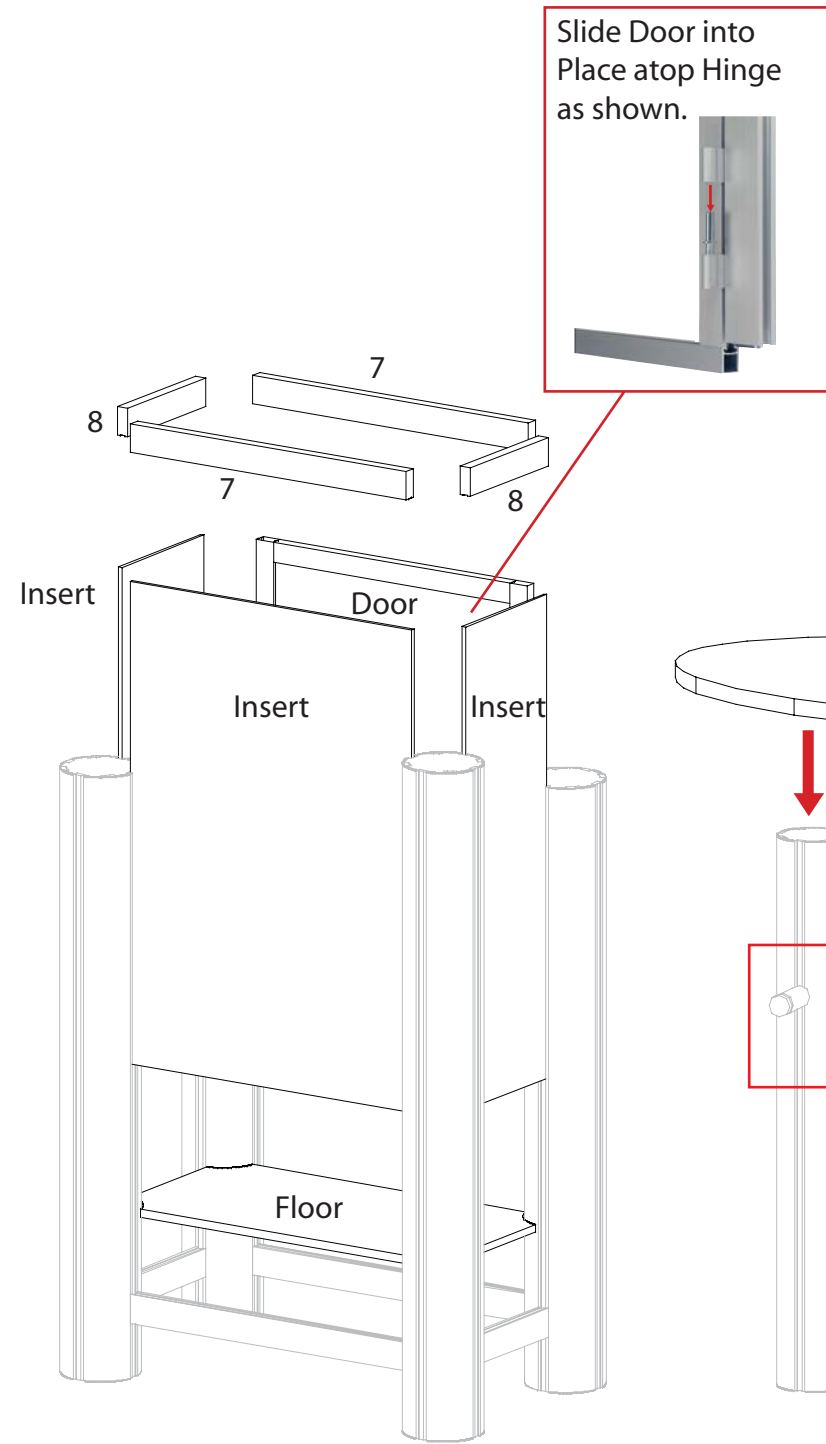
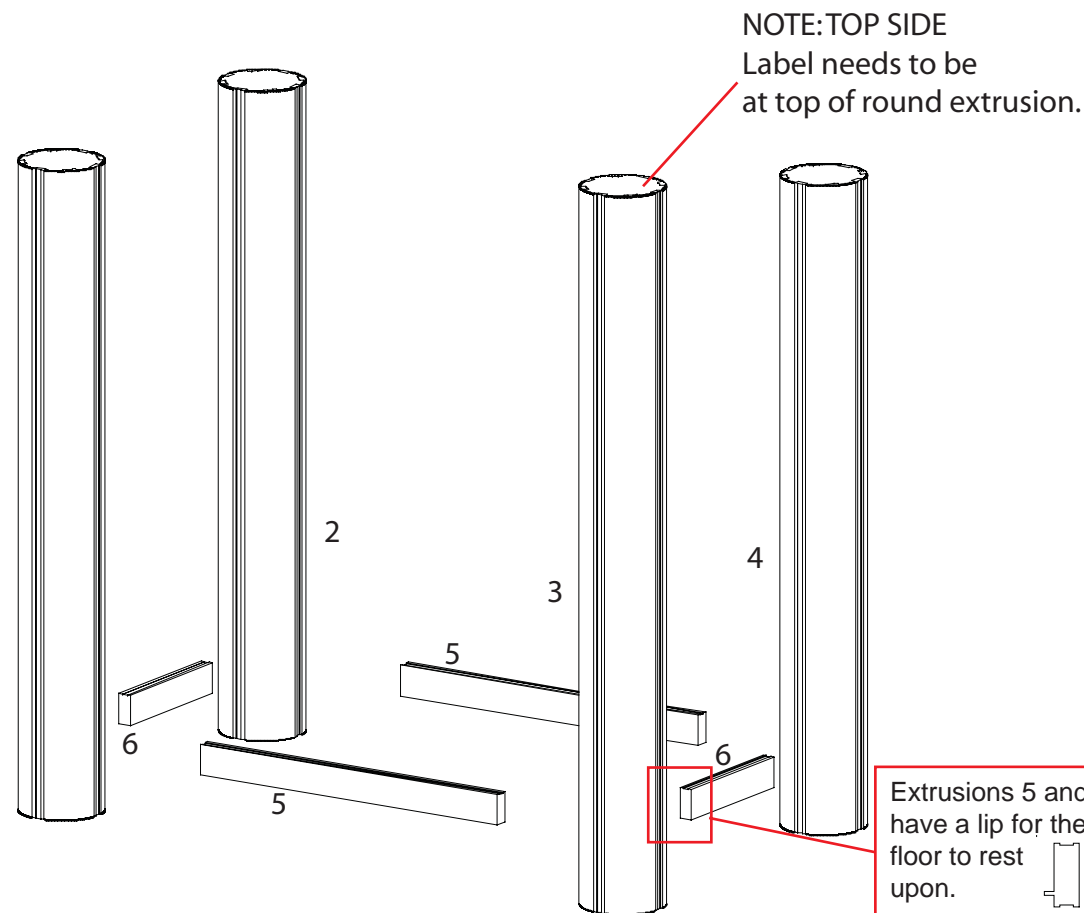

WHEN DISASSEMBLING ALUMINUM EXTRUSION, TIGHTEN ALL SETSCREWS AND LOCKS TO PREVENT LOSS DURING SHIPPING

visionary™ IDESIGNS

Using Your Setup Instructions

The Visionary Designs Setup Instructions are created specifically for your configuration. They are laid out sequentially, including an exploded view of the entire display, and then a logical series of detailed steps to assemble the main structure and components. We encourage you to study the instructions **before** attempting to assemble your exhibit.

Each page reminds you to tighten the setscrews after disassembling your exhibit to prevent loss of the locks and setscrews (see below in RED). This is **VERY IMPORTANT**.

Cleaning and Packing Your Display

- 1) Use care when cleaning aluminum extrusion or acrylic inserts. Use only non-abrasive cleaners.
- 2) When cleaning laminate inserts or countertops, use mild cleansers and a soft material such as cotton.
- 3) Keep all display components away from extreme heat and long exposure to sunlight to avoid warping and fading.
- 4) Retain all packing material. It will make re-packing much easier and will reduce the likelihood of shipping damage.



The Tool

Most Visionary Designs exhibits can be assembled with the supplied Hex Key Tool. Occasionally, a flat head screwdriver may be required.



Typical Connection

Most horizontal extrusion connections have a patented expandable lock. This lock inserts into the groove of an opposing extrusion. Tightening the lock with the Hex Key Tool expands the lock and creates a strong positive connection.



Typical Connection (cont'd)

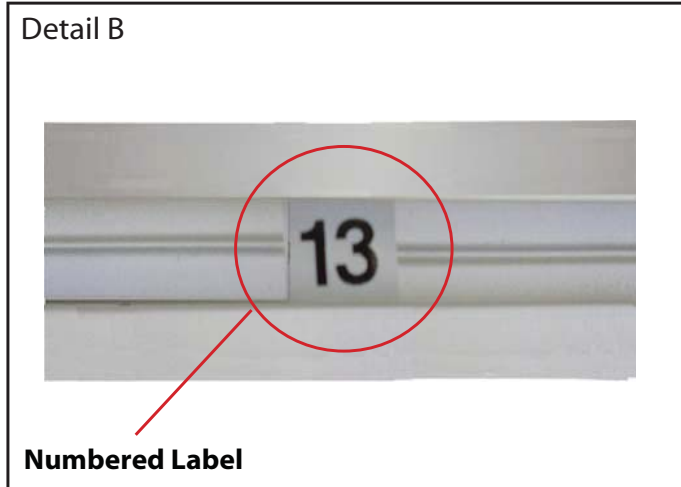

Detail B

Numbered Label

Each extrusion contains a numbered label which corresponds with setup instructions. The label is located within a groove of the extrusion (when possible). With Visionary Designs the labels contain Black numbers unless otherwise specified.



Detail C

Horizontal Inline Connection (remove only one setscrew)

Remove only (1) setscrew when disassembling. Replace setscrew in extrusion after assembling it. Before packing, replace setscrew in extrusion to avoid losing it.

NOTE :

PDF copies of your Setup Instructions are available @ www.classicexhibits.com
 Use the Search Tool located on the lower left-hand corner of the Classic Hor
 Enter your 5-7 digit Order #.

Search for Setup Instructions

WHEN DISASSEMBLING ALUMINUM EXTRUSION, TIGHTEN ALL SETSCREWS AND LOCKS TO PREVENT LOSS DURING SHIPPING

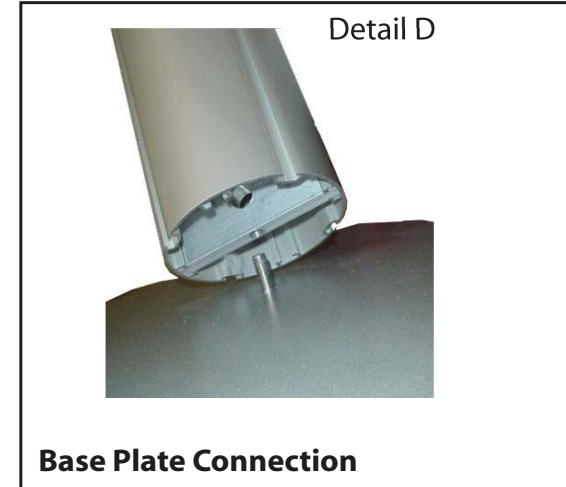

Detail D

Base Plate Connection

Attach base plate to round or square vertical extrusion using the bolt provided. Be careful not to strip the threads.

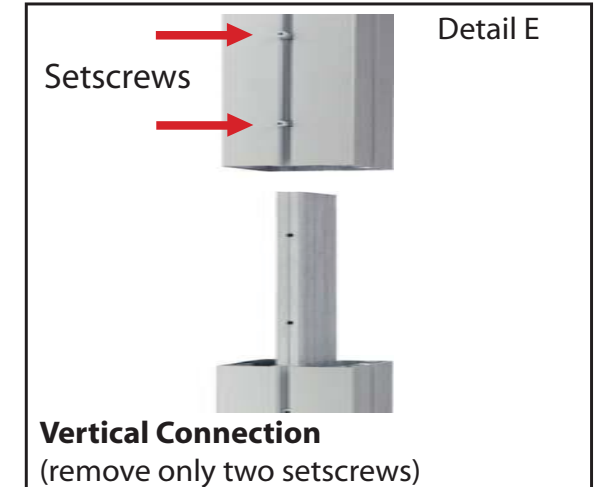

Detail E

Vertical Connection
(remove only two setscrews)

When vertical extrusions are packed in portable cases rather than crates or tubs, they must be broken down into smaller sections which then require assembly.

Remove only (2) setscrews when disassembling. Replace setscrews in extrusion after assembling it. Before packing, replace setscrews in extrusion to avoid losing them.

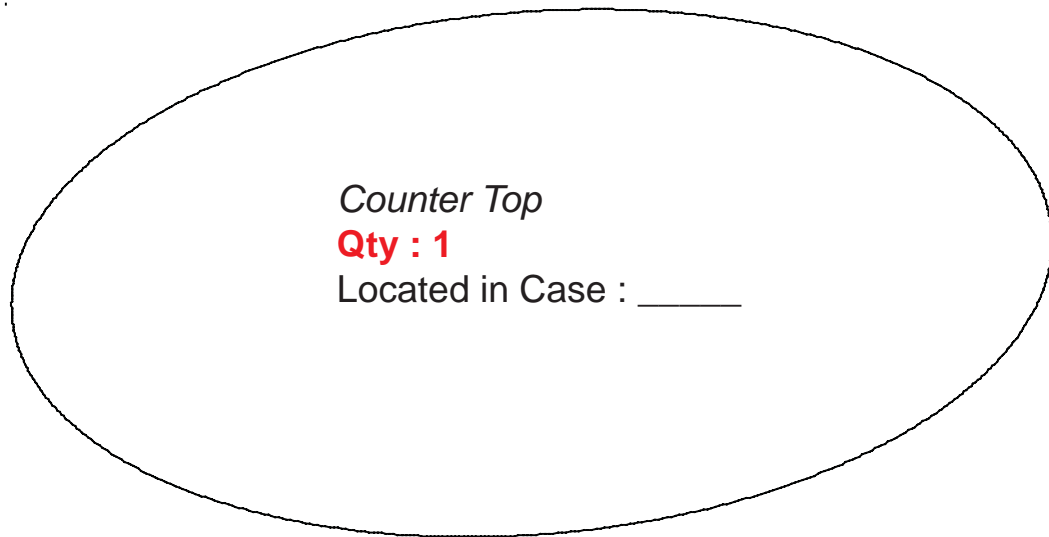

Counter Top
Qty : 1
Located in Case : _____

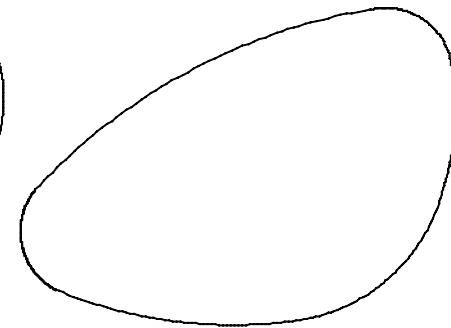

Small Counter Top
Qty : 1
Located in Case : _____

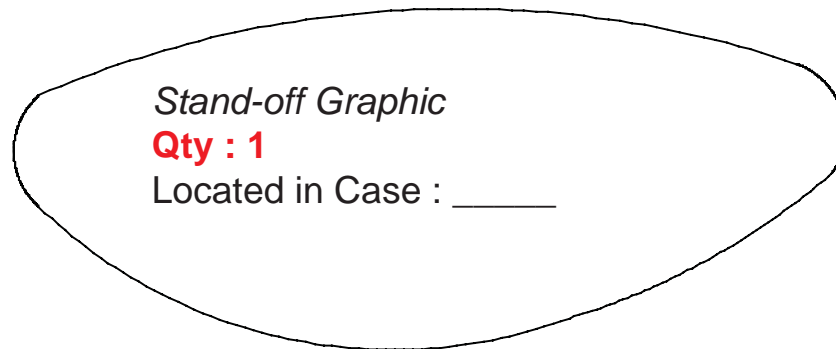

Stand-off Graphic
Qty : 1
Located in Case : _____

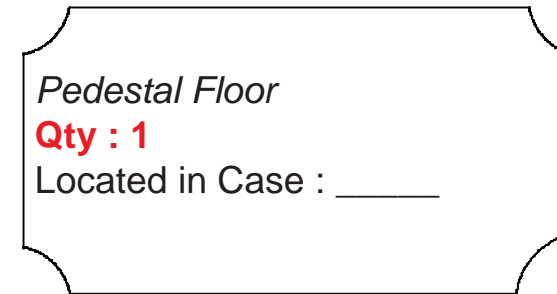

Pedestal Floor
Qty : 1
Located in Case : _____



Flange
Qty : 1
Located in Case : _____



38" h Round Vertical
Qty : 1
Located in Case : _____

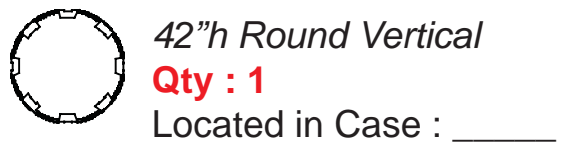

42" h Round Vertical
Qty : 1
Located in Case : _____



8.5" h Extrusion
Qty : 4
Located in Case : _____



20" Extrusion
Qty : 4
Located in Case : _____

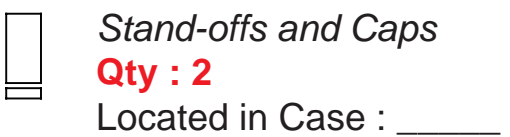

Stand-offs and Caps
Qty : 2
Located in Case : _____

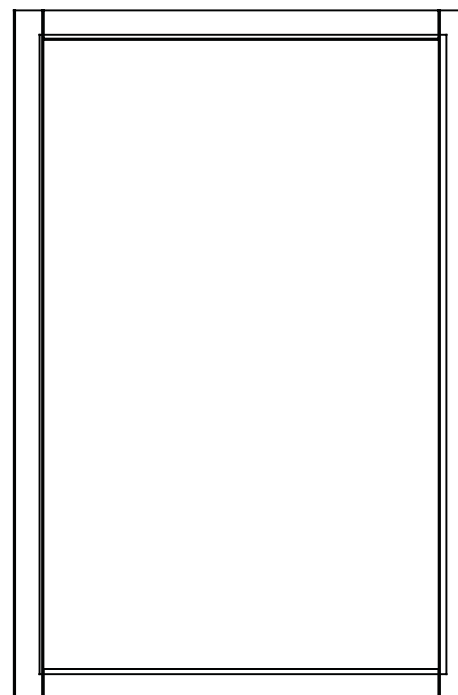

Locking Door
Qty : 1
Located in Case : _____

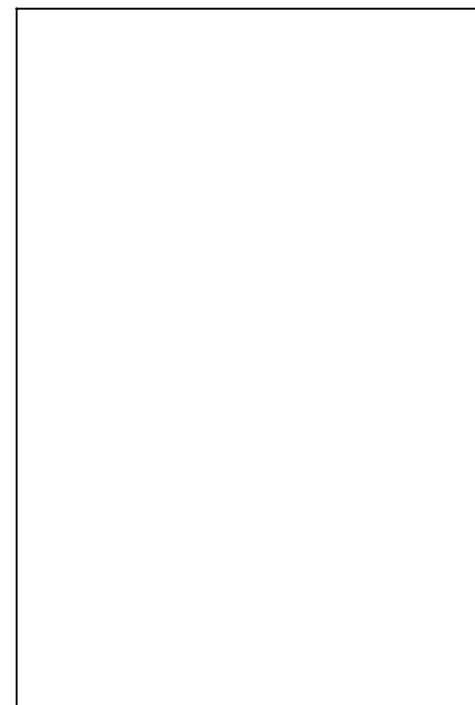

20.4375" w x 30.3343" h Insert
Qty : 2
Located in Case : _____

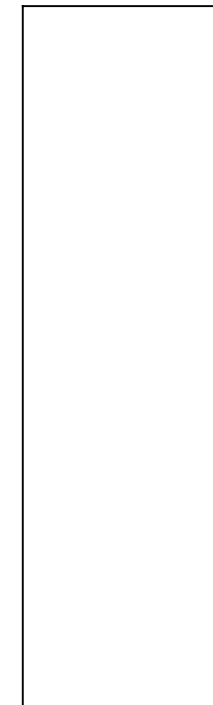

8.9375" w x 30.3343" h Insert
Qty : 2
Located in Case : _____

Additional Accessories:

Hex Key set

Located in Case : _____

WHEN DISASSEMBLING ALUMINUM EXTRUSION, TIGHTEN ALL SETSCREWS AND LOCKS TO PREVENT LOSS DURING SHIPPING

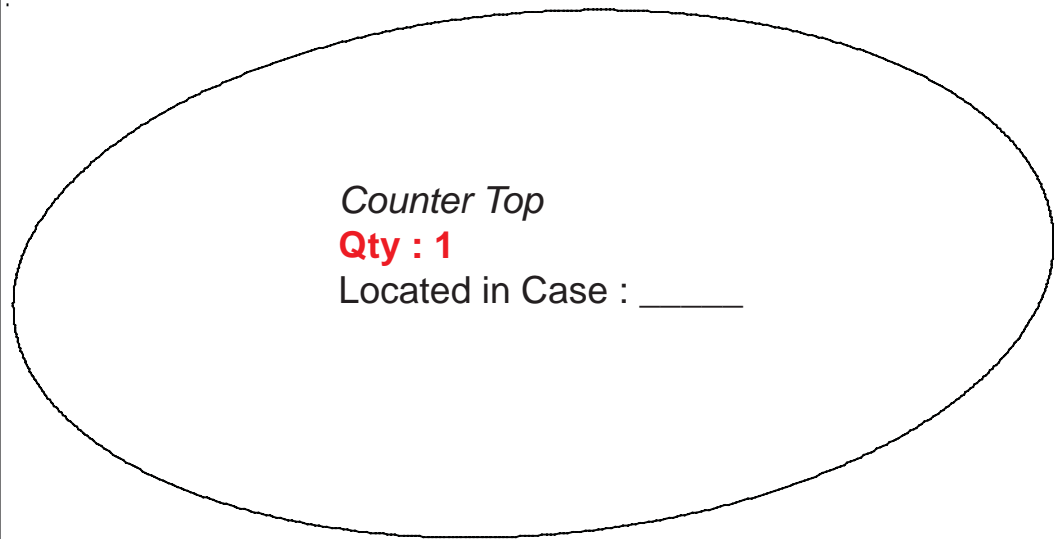

Counter Top
Qty : 1
Located in Case : _____

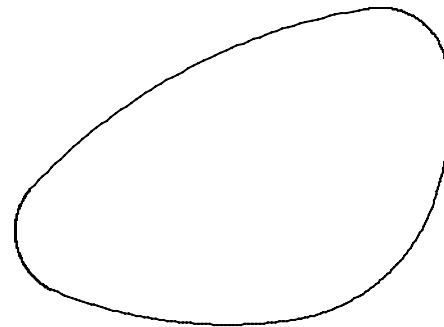

Small Counter Top
Qty : 1
Located in Case : _____

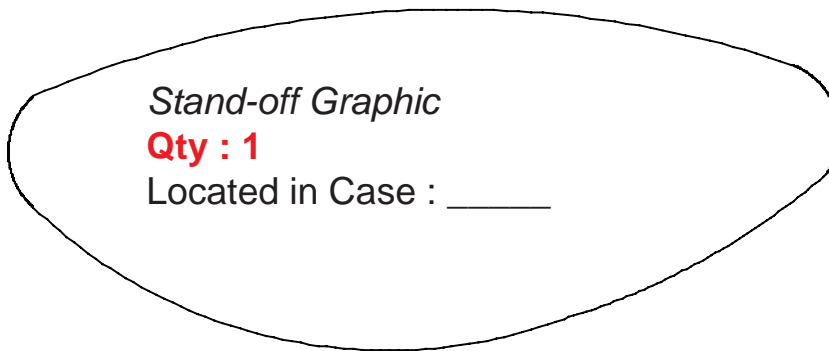

Stand-off Graphic
Qty : 1
Located in Case : _____



Pedestal Floor
Qty : 1
Located in Case : _____

 Flange
Qty : 1
Located in Case : _____

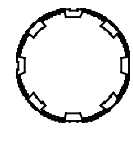
 38" Round Vertical
Qty : 1
Located in Case : _____

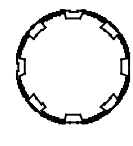
 42" Round Vertical
Qty : 1
Located in Case : _____

 8.5" Extrusion
Qty : 4
Located in Case : _____

 20" Extrusion
Qty : 4
Located in Case : _____

 Stand-offs and Caps
Qty : 2
Located in Case : _____

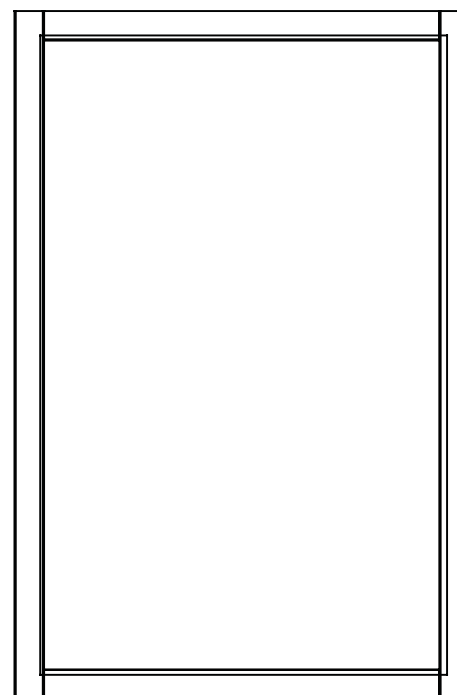

Locking Door
Qty : 1
Located in Case : _____



20.4375"w x 30.3343"h Insert
Qty : 2
Located in Case : _____

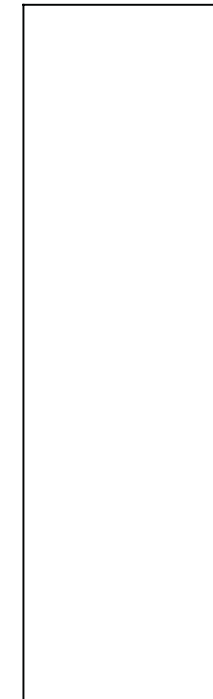

8.9375"w x 30.3343"h Insert
Qty : 2
Located in Case : _____

Additional Accessories:

Hex Key set

Located in Case : _____

WHEN DISASSEMBLING ALUMINUM EXTRUSION, TIGHTEN ALL SETSCREWS AND LOCKS TO PREVENT LOSS DURING SHIPPING