

euro It

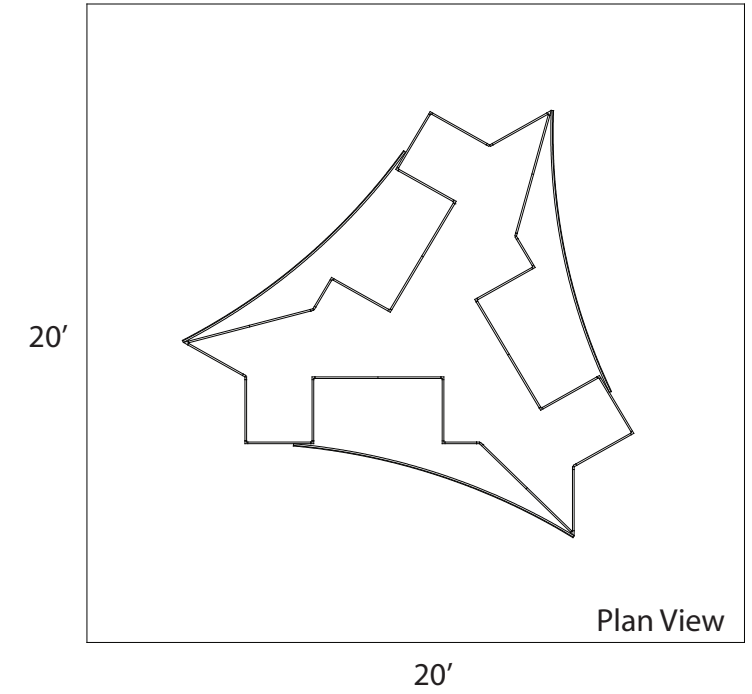
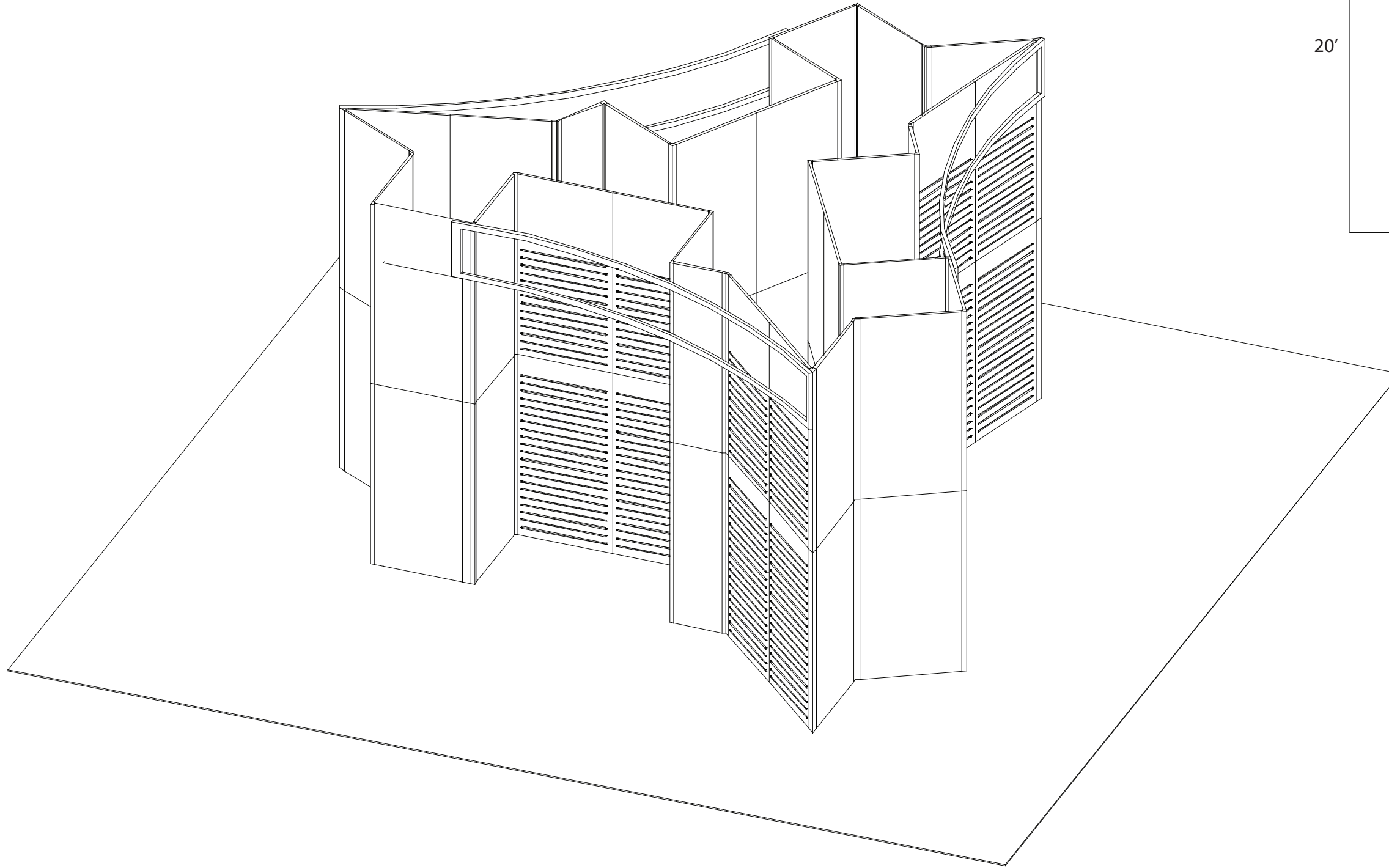

euro lt | HYBRIDS

Euro LT Hybrids General Setup Instructions

Using Your Setup Instructions

The Euro LT Hybrids Setup Instructions are created specifically for your configuration. They are laid out sequentially in levels, including exploded views, and a logical series of detailed steps to assemble the main structure and components. We encourage you to study the instructions **before** attempting to assemble your exhibit.

Cleaning and Packing Your Display

- 1) When cleaning laminate countertops or panels use mild cleansers and a soft material such as cotton.
- 2) Keep all display components away from extreme heat and long exposure to sunlight to avoid warping and fading.
- 3) Retain all packing material. It will make re-packing much easier and will reduce the likelihood of shipping damage.

Level 1 = Blue
 Level 2 = Red
 Level 3 = Green
 Level 4 = Black

Color Code

The top clip is color coded to distinguish the level. The color coded clip also contains the numbered label

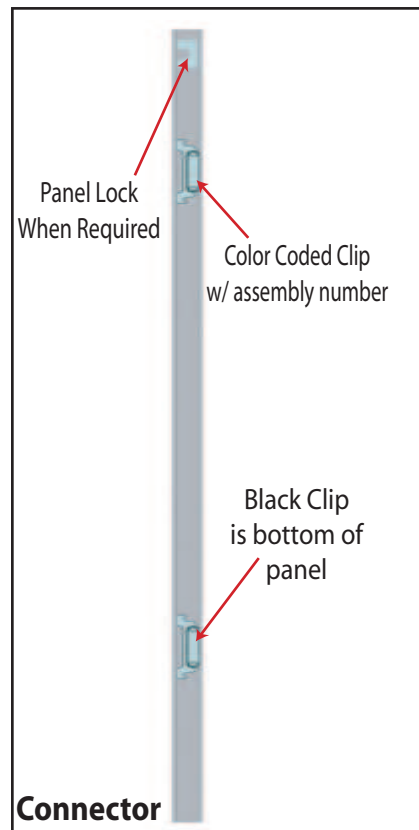

Each component has 2 clips, the lower clip is ALWAYS black..

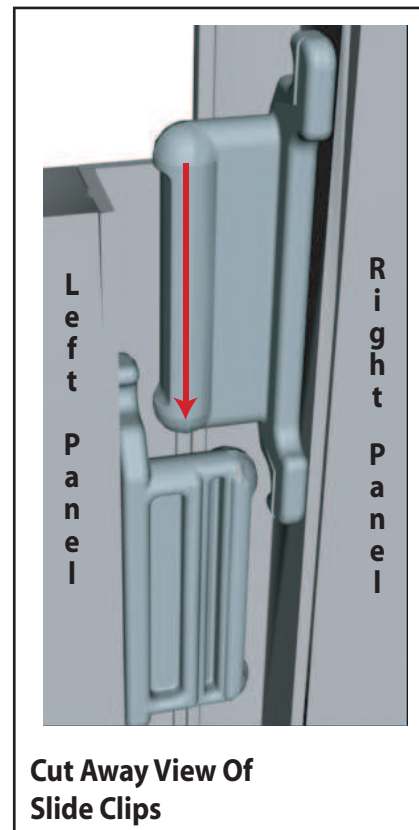

Components connect together by aligning them and sliding downward connecting clips together.

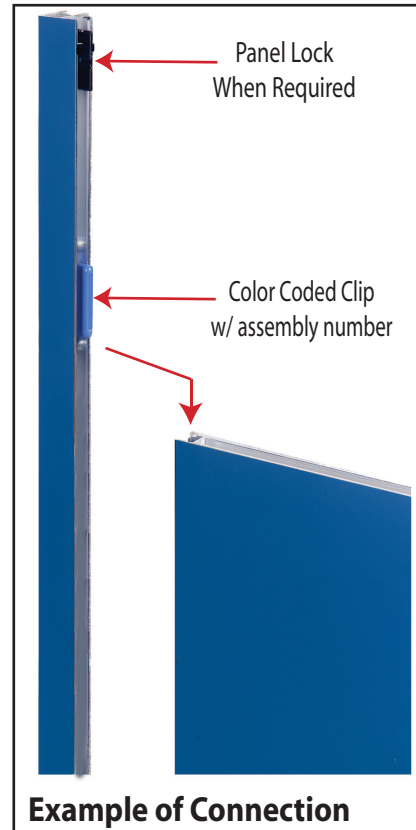

Configurations are assembled from left to right, usually starting with #1 and following the numbered sequence.

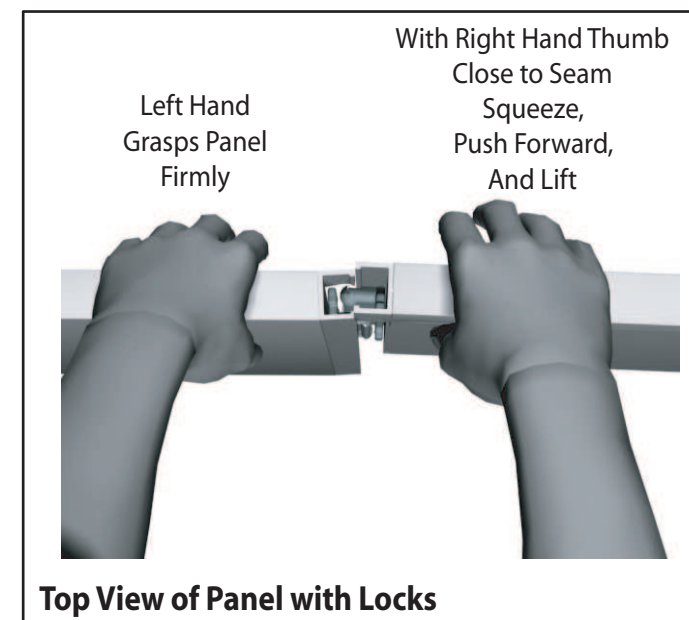

The first level of components contains panel locks that are located at the top of the panel for extra stability and a seamless connection. When disassembling panels, twist top connection slightly and lift right panel upward.

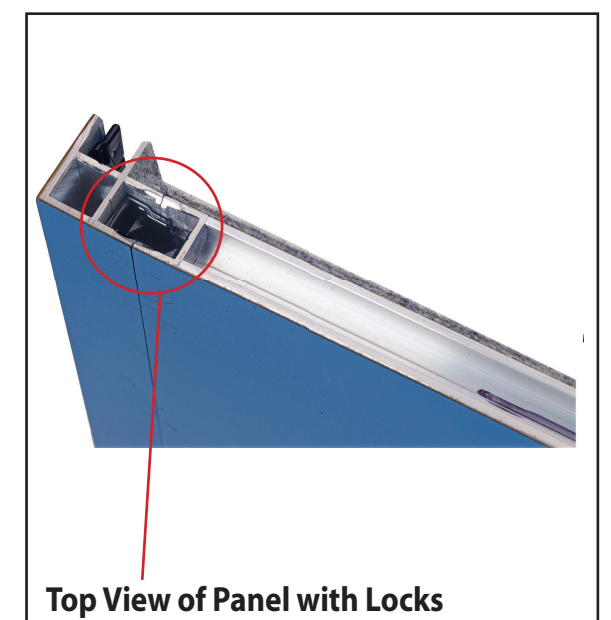

Item Number	Description	Item Number	Description
1	Lower Conference Door	40	47.5"h Flex Connector
1A	Door Stop	41	23"w x 47.5"h Flat Panel
2	47.5"h 90° Connector	42	47.5"h 45° Connector
3	23"w x 47.5"h Flat Panel	43	23"w x 47.5"h Slatwall Panel
4	47.5"h Flex Connector	44	23"w x 47.5"h Slatwall Panel
5	23"w x 47.5"h Flat Panel	45	47.5"h Flex Connector
6	47.5"h 45° Connector	46	11.5"w x 47.5"h Flat Panel
7	23"w x 47.5"h Slatwall Panel	47	47.5"h 90° Connector
8	23"w x 47.5"h Slatwall Panel	48	23"w x 47.5"h Flat Panel
9	47.5"h Flex Connector	49	47.5"h 90° Connector
10	11.5"w x 47.5"h Flat Panel	50	23"w x 47.5"h Slatwall Panel
11	47.5"h 90° Connector	51	23"w x 47.5"h Slatwall Panel
12	23"w x 47.5"h Flat Panel	52	47.5"h 90° Connector
13	47.5"h 90° Connector	53	23"w x 47.5"h Flat Panel
14	23"w x 47.5"h Slatwall Panel	54	47.5"h 90° Connector
15	23"w x 47.5"h Slatwall Panel		
16	47.5"h 90° Connector		
17	23"w x 47.5"h Flat Panel		
18	47.5"h 90° Connector		
19	23"w x 47.5"h Flat Panel		
20	47.5"h 90° Connector		
21	23"w x 47.5"h Flat Panel		
22	47.5"h Flex Connector		
23	23"w x 47.5"h Flat Panel		
24	47.5"h 45° Connector		
25	23"w x 47.5"h Slatwall Panel		
26	23"w x 47.5"h Slatwall Panel		
27	47.5"h Flex Connector		
28	11.5"w x 47.5"h Flat Panel		
29	47.5"h 90° Connector		
30	23"w x 47.5"h Flat Panel		
31	47.5"h 90° Connector		
32	23"w x 47.5"h Slatwall Panel		
33	23"w x 47.5"h Slatwall Panel		
34	47.5"h 90° Connector		
35	23"w x 47.5"h Flat Panel		
36	47.5"h 90° Connector		
37	23"w x 47.5"h Flat Panel		
38	47.5"h 90° Connector		
39	23"w x 47.5"h Flat Panel		

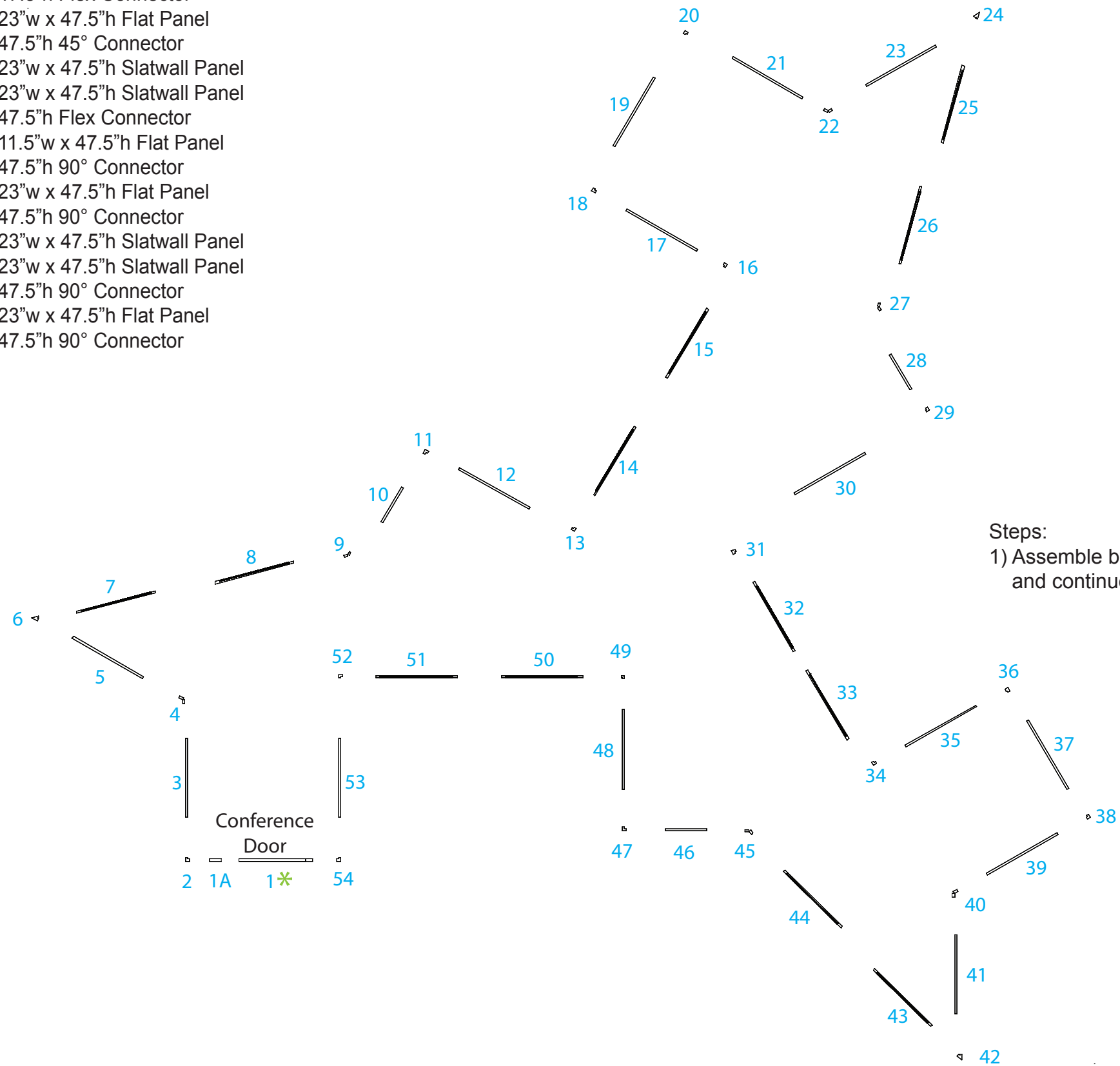

Steps:
 1) Assemble by starting at panel #1* and continue in numerical order.

Item Number	Description	Item Number	Description
1	Upper Conference Door	40	47.5" h Flex Connector
2	47.5" h 90° Connector	41	23" w x 47.5" h Flat Panel
3	23" w x 47.5" h Flat Panel	42	47.5" h 45° Connector
4	47.5" h Flex Connector	43	23" w x 47.5" h Slatwall Panel
5	23" w x 47.5" h Flat Panel	44	23" w x 47.5" h Slatwall Panel
6	47.5" h 45° Connector	45	47.5" h Flex Connector
7	23" w x 47.5" h Slatwall Panel	46	11.5" w x 47.5" h Flat Panel
8	23" w x 47.5" h Slatwall Panel	47	47.5" h 90° Connector
9	47.5" h Flex Connector	48	23" w x 47.5" h Flat Panel
10	11.5" w x 47.5" h Flat Panel	49	47.5" h 90° Connector
11	47.5" h 90° Connector	50	23" w x 47.5" h Slatwall Panel
12	23" w x 47.5" h Flat Panel	51	23" w x 47.5" h Slatwall Panel
13	47.5" h 90° Connector	52	47.5" h 90° Connector
14	23" w x 47.5" h Slatwall Panel	53	23" w x 47.5" h Flat Panel
15	23" w x 47.5" h Slatwall Panel	54	47.5" h 90° Connector
16	47.5" h 90° Connector		
17	23" w x 47.5" h Flat Panel		
18	47.5" h 90° Connector		
19	23" w x 47.5" h Flat Panel		
20	47.5" h 90° Connector		
21	23" w x 47.5" h Flat Panel		
22	47.5" h Flex Connector		
23	23" w x 47.5" h Flat Panel		
24	47.5" h 45° Connector		
25	23" w x 47.5" h Slatwall Panel		
26	23" w x 47.5" h Slatwall Panel		
27	47.5" h Flex Connector		
28	11.5" w x 47.5" h Flat Panel		
29	47.5" h 90° Connector		
30	23" w x 47.5" h Flat Panel		
31	47.5" h 90° Connector		
32	23" w x 47.5" h Slatwall Panel		
33	23" w x 47.5" h Slatwall Panel		
34	47.5" h 90° Connector		
35	23" w x 47.5" h Flat Panel		
36	47.5" h 90° Connector		
37	23" w x 47.5" h Flat Panel		
38	47.5" h 90° Connector		
39	23" w x 47.5" h Flat Panel		

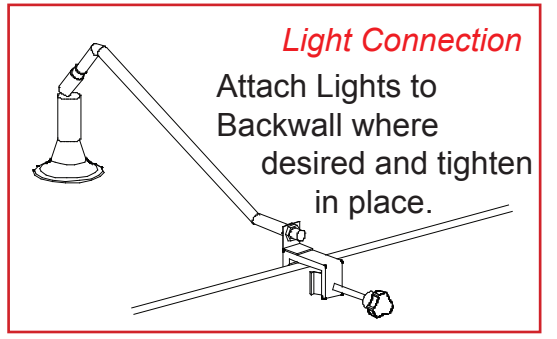
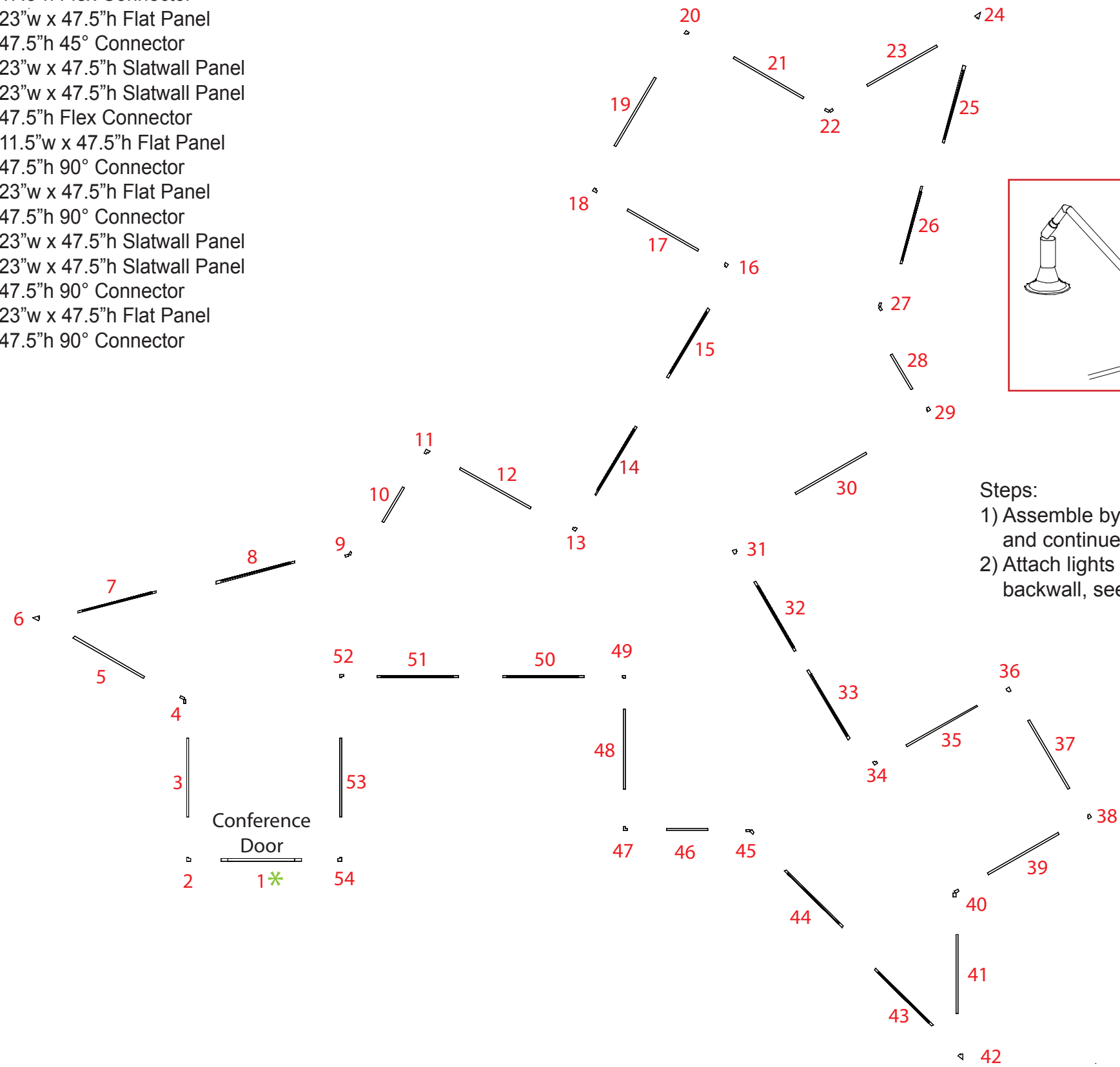

- Steps:
- 1) Assemble by starting at panel #1* and continue in numerical order.
 - 2) Attach lights to top of assembled backwall, see Light Connection detail.

866.652.2100

Steps:

- 1) Hook header to top of assembled backwall as indicated.
- 2) Velcro left and right side of header to backwall as indicated.

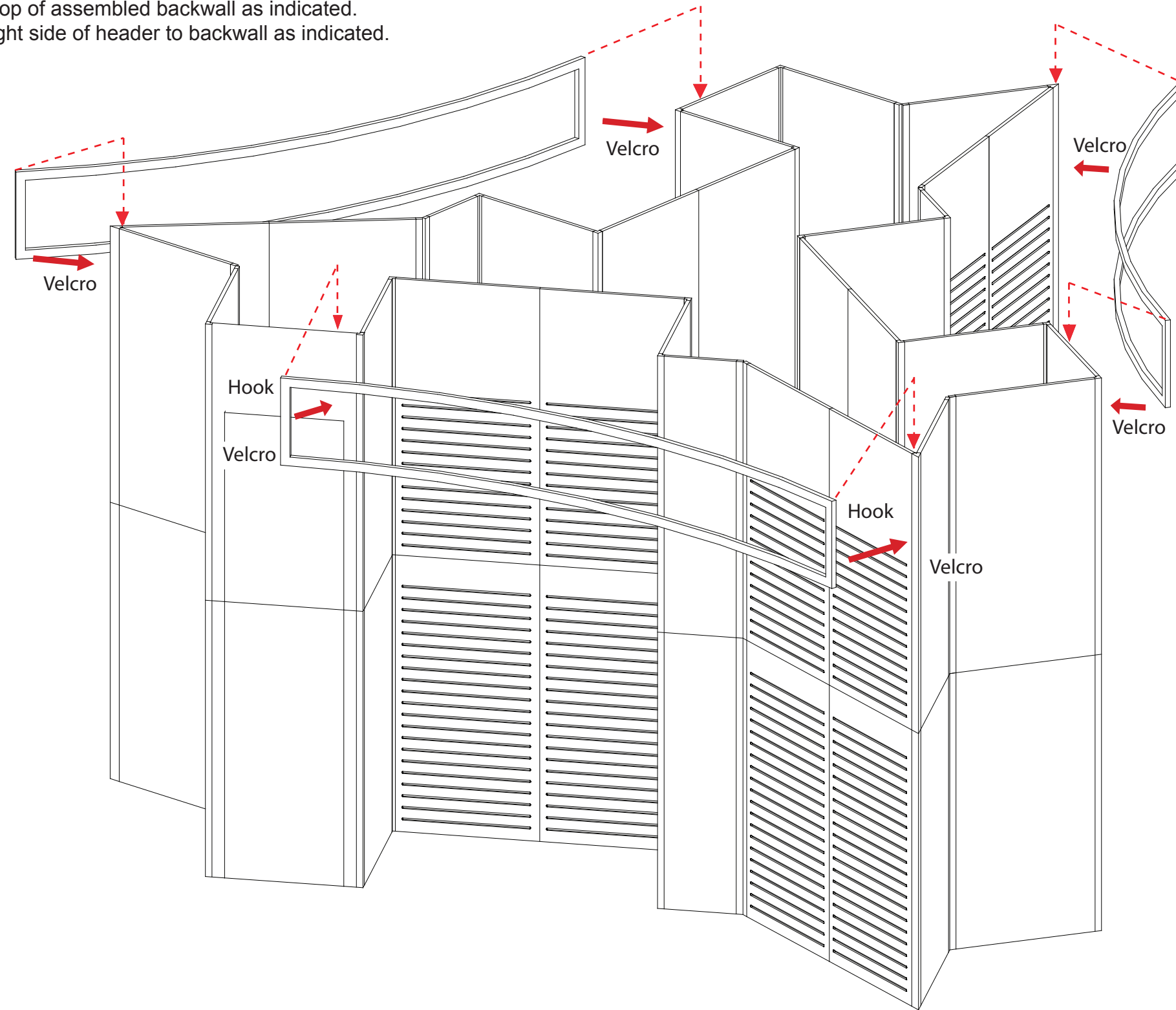

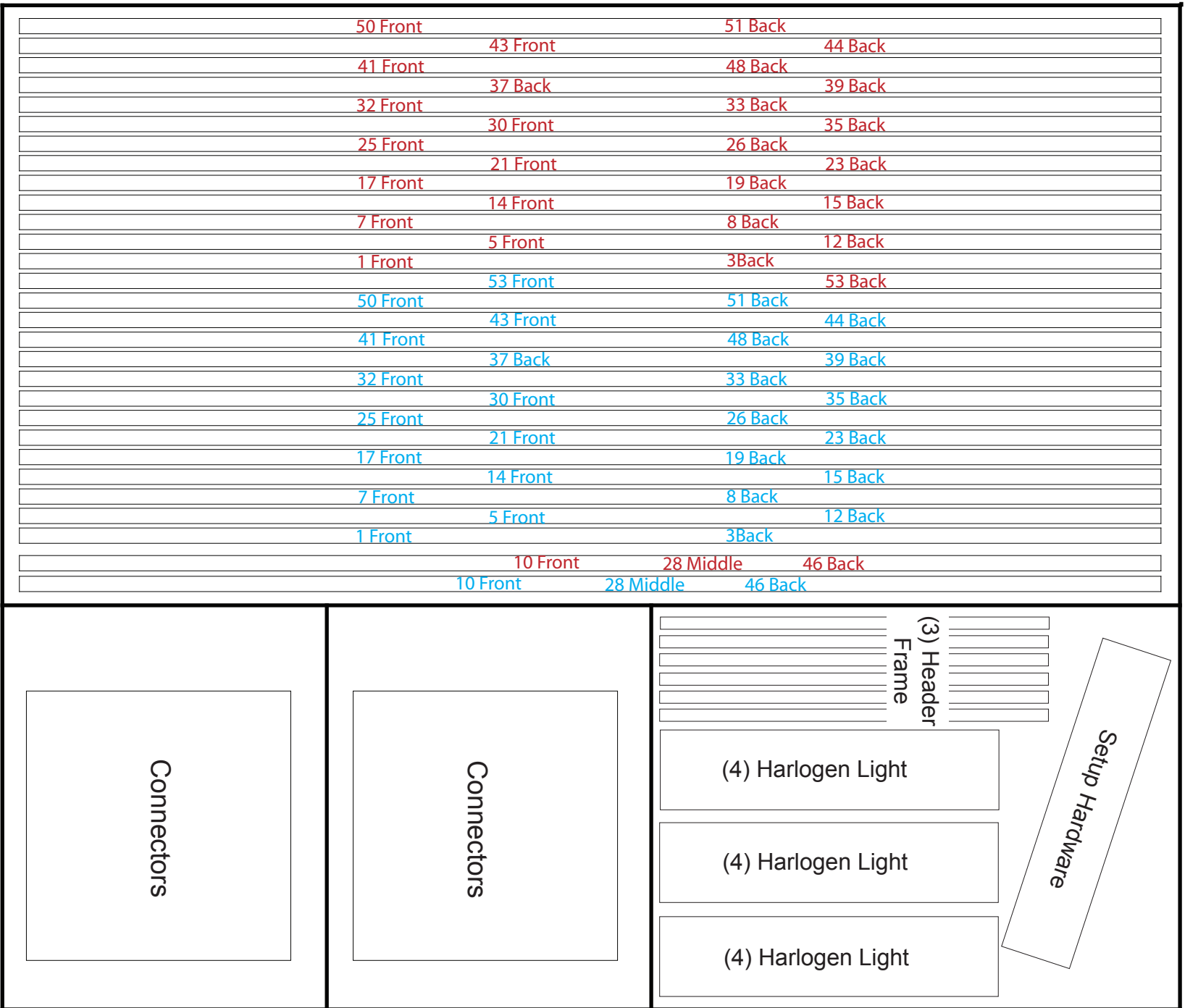

Crate Front View

