

WHEN DISASSEMBLING ALUMINUM EXTRUSION, TIGHTEN ALL SETSCREWS AND LOCKS TO PREVENT LOSS DURING SHIPPING

visionary™ DESIGNS

Using Your Setup Instructions

The Visionary Designs Setup Instructions are created specifically for your configuration. They are laid out sequentially, including an exploded view of the entire display, and then a logical series of detailed steps to assemble the main structure and components. We encourage you to study the instructions **before** attempting to assemble your exhibit.

Each page reminds you to tighten the setscrews after disassembling your exhibit to prevent loss of the locks and setscrews (see below in RED). This is **VERY IMPORTANT**.

Cleaning and Packing Your Display

- 1) Use care when cleaning aluminum extrusion or acrylic inserts. Use only non-abrasive cleaners.
- 2) When cleaning laminate inserts or countertops, use mild cleansers and a soft material such as cotton.
- 3) Keep all display components away from extreme heat and long exposure to sunlight to avoid warping and fading.
- 4) Retain all packing material. It will make re-packing much easier and will reduce the likelihood of shipping damage.



The Tool

Most Visionary Designs exhibits can be assembled with the supplied Hex Key Tool. Occasionally, a flat head screwdriver may be required.



Typical Connection

Most horizontal extrusion connections have a patented expandable lock. This lock inserts into the groove of an opposing extrusion. Tightening the lock with the Hex Key Tool expands the lock and creates a strong positive connection.



Typical Connection (cont'd)

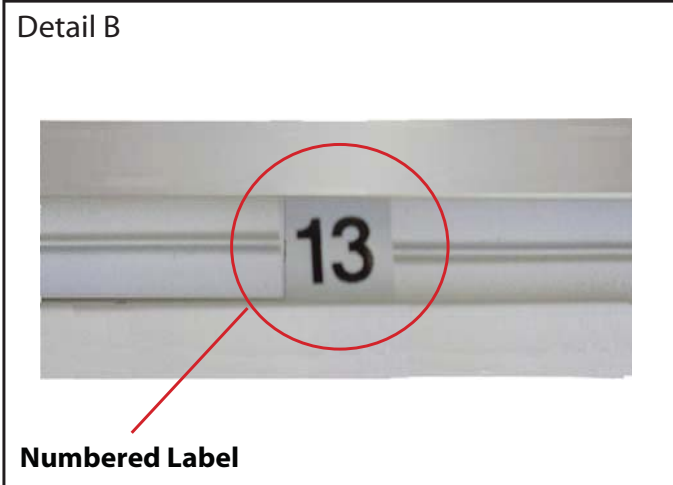

Numbered Label

Each extrusion contains a numbered label which corresponds with setup instructions. The label is located within a groove of the extrusion (when possible). With Visionary Designs the labels contain Black numbers unless otherwise specified.



Horizontal Inline Connection (remove only one setscrew)

Remove only (1) setscrew when disassembling. Replace setscrew in extrusion after assembling it. Before packing, replace setscrew in extrusion to avoid losing it.

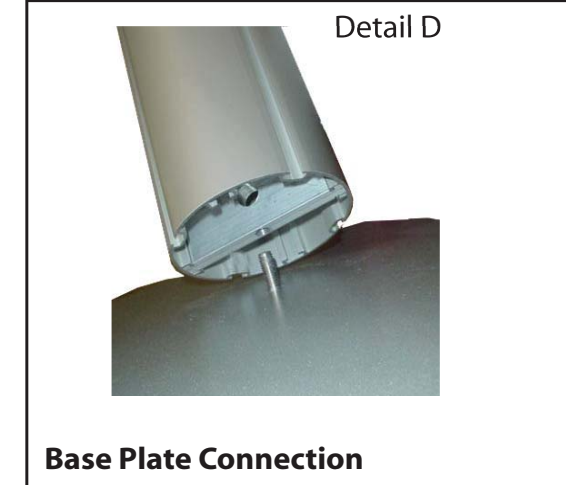

Base Plate Connection

Attach base plate to round or square vertical extrusion using the bolt provided. Be careful not to strip the threads.

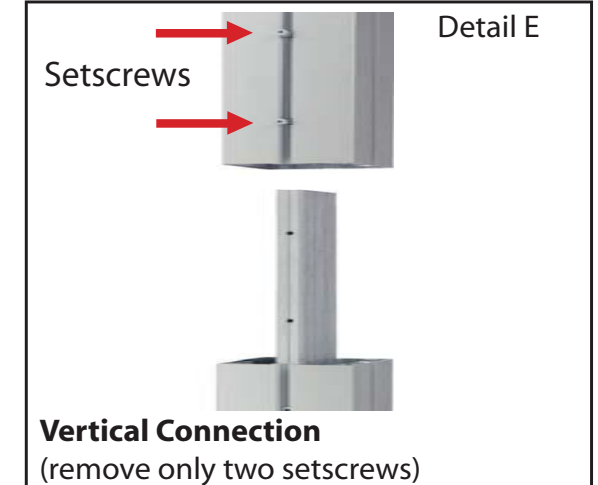

Vertical Connection
(remove only two setscrews)

When vertical extrusions are packed in portable cases rather than crates or tubs, they must be broken down into smaller sections which then require assembly.

Remove only (2) setscrews when disassembling. Replace setscrews in extrusion after assembling it. Before packing, replace setscrews in extrusion to avoid losing them.

WHEN DISASSEMBLING ALUMINUM EXTRUSION, TIGHTEN ALL SETSCREWS AND LOCKS TO PREVENT LOSS DURING SHIPPING

866.652.2100

Part Number	Qty	Description
1	1	Base Plate w/ one hole
2	1	48.0501" h Lower Curved Vertical extrusion
3	1	48.0501" h Upper Curved Vertical extrusion
4	1	Base Plate w/ two holes
5	1	48.0501" h Lower Curved Vertical extrusion
6	1	48.0501" h Upper Curved Vertical extrusion
7	1	48.0501" h Lower Curved Vertical extrusion
8	1	48.0501" h Upper Curved Vertical extrusion
9	1	Base Plate w/ one hole
10	1	48.0501" h Lower Curved Vertical extrusion
11	1	44.2049" h Upper Curved Vertical extrusion
12a/12b	1/1	38" w Horizontal extrusion tapered one end
13a/13b	1/1	38" w Horizontal extrusion tapered one end
14	3	12" w Horizontal extrusion
15	1	38" w Horizontal extrusion tapered one end
16	1	16.614" h Vertical extrusion tapered one end
17	1	35.04" w Horizontal extrusion
18	1	21.29" w Horizontal extrusion tapered both ends
19	1	23.773" w Horizontal extrusion tapered both ends
20	1	22.44" w Horizontal extrusion tapered one end
21	1	Horizontal extrusion tapered both ends
22	1	Horizontal extrusion tapered both ends

Steps

- 1) Connect curved vertical extrusions [2 to 3, 5 to 6, 7 to 8 and 10 to 11] together.
- 2) Attach vertical assemblies [2/3, 5/6, 7/8 and 10/11] to base plates indicated, extrusion [14] will need to be connected between vertical assemblies [5/6 and 7/8] by connecting [5/6] to base plate, then attaching extrusion [14] and finally adding [7/8].
NOTE: See detail for connection.
- 3) Connect horizontal extrusions [12a to 12 b and 13a to 13b] together.
- 4) Attach vertical assemblies [12a/12b and 13a/13b] between vertical assemblies [2/3 and 5/6].
- 5) Connect extrusion [14] to slot located in [13b].
- 6) Assemble extrusions [15, 16 and 17] together by first attaching [16] flush to bottom left edge of [15], then attach [17] flush to bottom right edge of [16].
- 7) Attach assembly [15/16/17] to extrusions [8 and 14], making right edge of [15] flush with top of [8].
- 8) Attach horizontal extrusions [18 thru 22] between vertical assemblies [7/8 and 10/11] making sure that the right edge of [20] is flush to the top of [11].

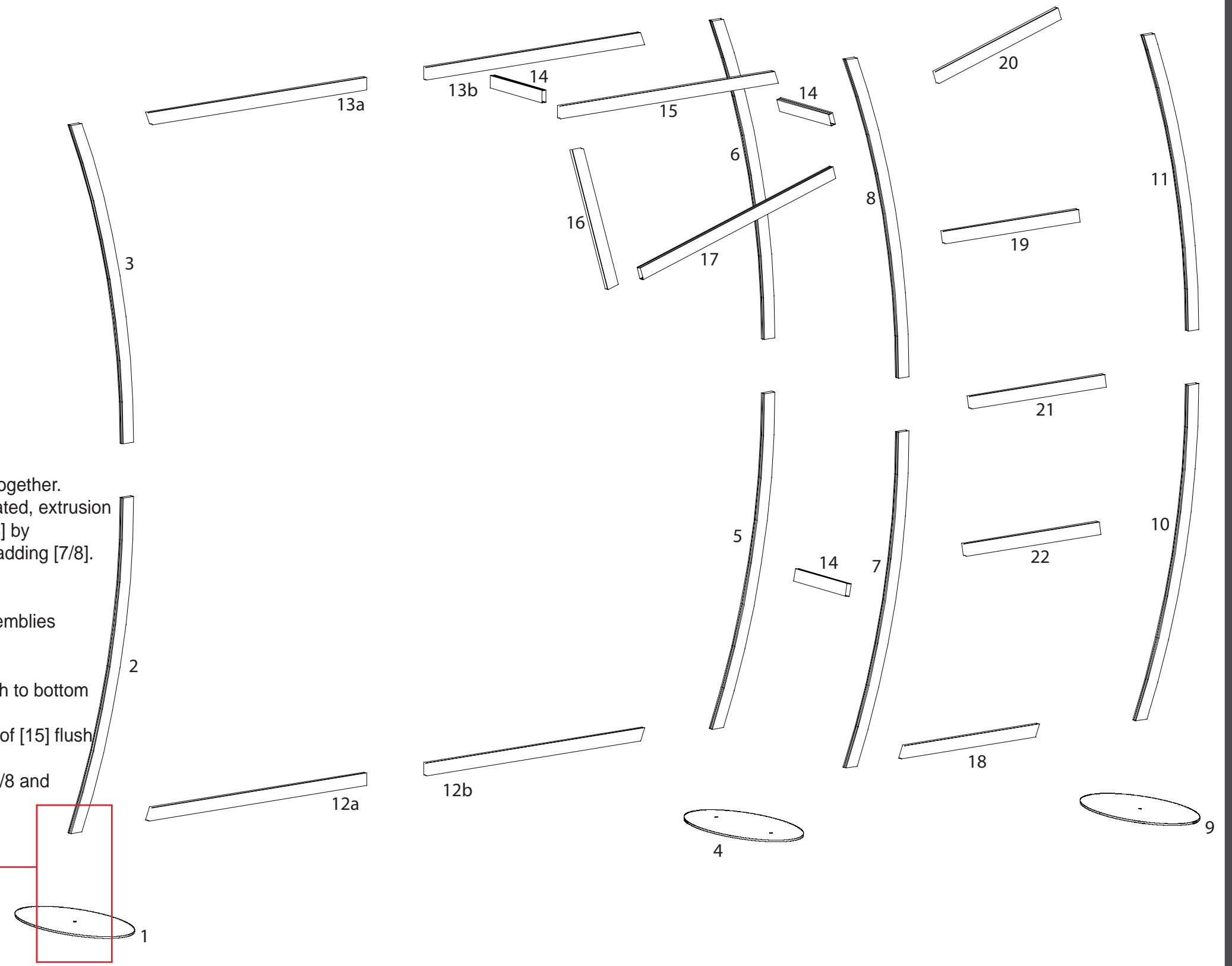

Connect Vertical Extrusions to Base Plates by placing lock into slot and tighten with tool.

WHEN DISASSEMBLING ALUMINUM EXTRUSION, TIGHTEN ALL SETSCREWS AND LOCKS TO PREVENT LOSS DURING SHIPPING

866.652.2100

Wing Attachment

Slide A10 Clamp into groove of curved extrusion.

When desired location is found, tighten set screw to secure.

Tighten black plastic set screw to secure Wing in place.

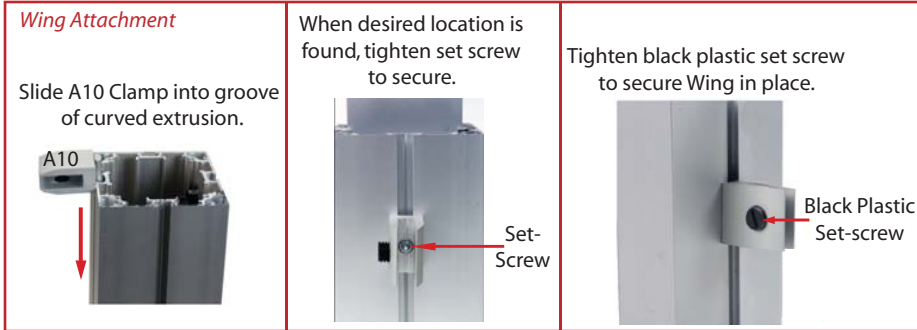

A10

Set-Screw

Black Plastic Set-screw

MONITOR MOUNT

Attach monitor mount to Horizontal extrusion after assembly.

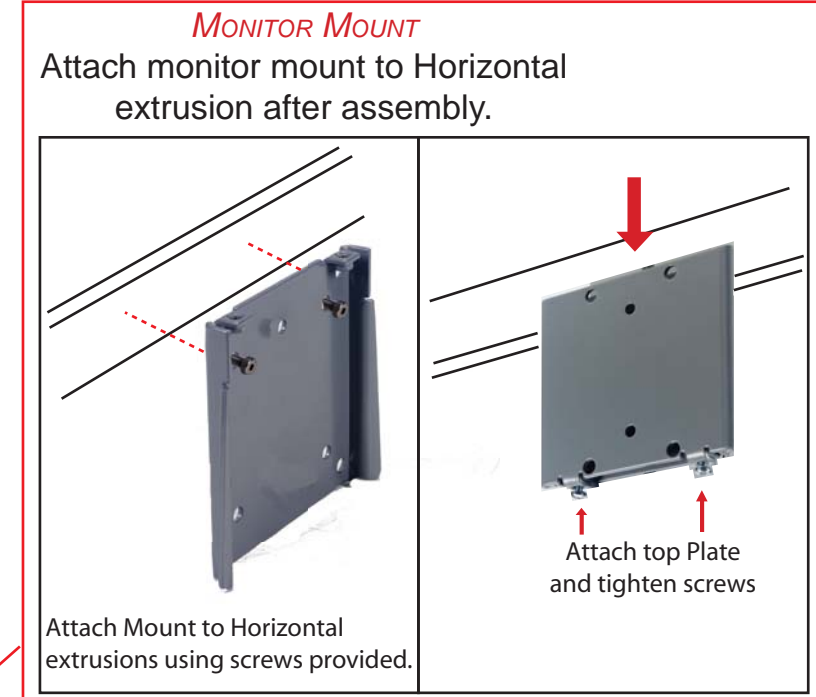

Attach Mount to Horizontal extrusions using screws provided.

Attach top Plate and tighten screws

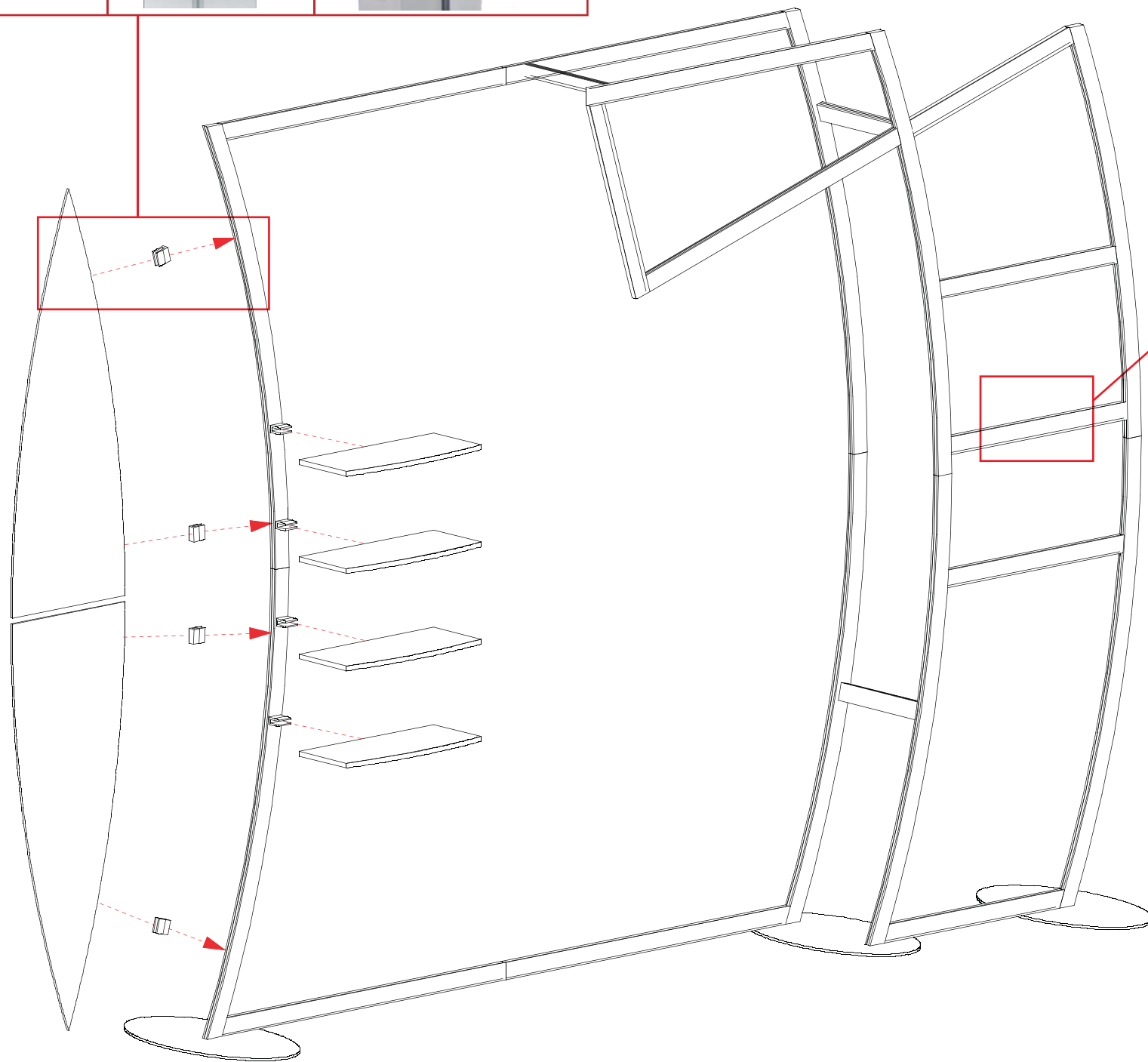

WHEN DISASSEMBLING ALUMINUM EXTRUSION, TIGHTEN ALL SETSCREWS AND LOCKS TO PREVENT LOSS DURING SHIPPING

866.652.2100

Additional Accessories:

48.05" h Curved Extrusion

Qty. : 7

Located in Case : _____

44.2049" h Curved Extrusion

Qty. : 1

Located in Case : _____

38" h Extrusion

Qty. : 5

Located in Case : _____

35.04" h Extrusion

Qty. : 4

Located in Case : _____

24.247" h Extrusion

Qty. : 4

Located in Case : _____

23.773" h Extrusion

Qty. : 3

Located in Case : _____

22.44" h Extrusion

Qty. : 1

Located in Case : _____

21.686" h Extrusion

Qty. : 1

Located in Case : _____

12" h Extrusion

Qty. : 3

Located in Case : _____

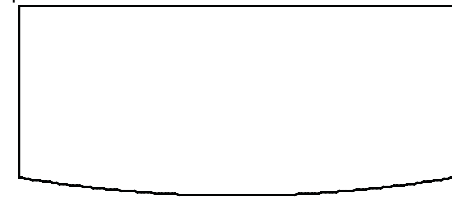

Shelves

Qty. : 3

Located in Case : _____

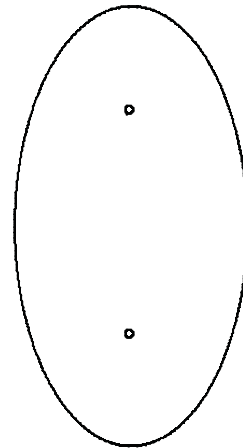

Oval Base Plate w/ 2 holes

Qty. : 1

Located in Case : _____

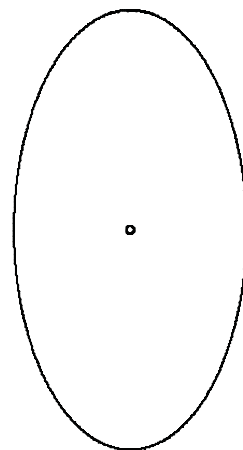

Oval Base Plate w/ 1 hole

Qty. : 3

Located in Case : _____

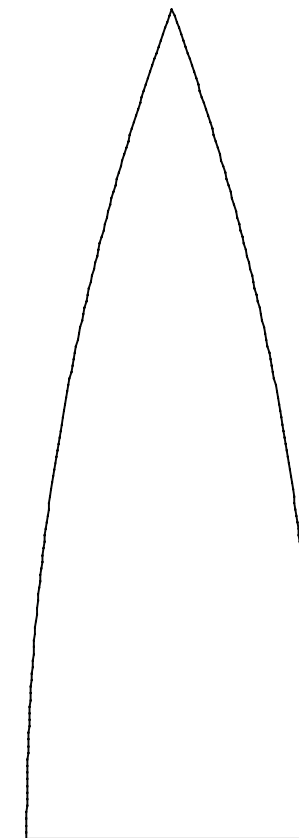

Wing Panel

Qty. : 2

Located in Case : _____

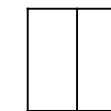

A-10 Clamps

Qty. : 4

Located in Case : _____

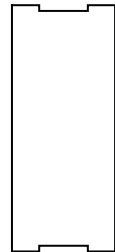

WHEN DISASSEMBLING ALUMINUM EXTRUSION, TIGHTEN ALL SETSCREWS AND LOCKS TO PREVENT LOSS DURING SHIPPING