

WHEN DISASSEMBLING ALUMINUM EXTRUSION, TIGHTEN ALL SETSCREWS AND LOCKS TO PREVENT LOSS DURING SHIPPING

visionary™ IDESIGNS

Using Your Setup Instructions

The Visionary Designs Setup Instructions are created specifically for your configuration. They are laid out sequentially, including an exploded view of the entire display, and then a logical series of detailed steps to assemble the main structure and components. We encourage you to study the instructions **before** attempting to assemble your exhibit.

Each page reminds you to tighten the setscrews after disassembling your exhibit to prevent loss of the locks and setscrews (see below in RED). This is **VERY IMPORTANT**.

Cleaning and Packing Your Display

- 1) Use care when cleaning aluminum extrusion or acrylic inserts. Use only non-abrasive cleaners.
- 2) When cleaning laminate inserts or countertops, use mild cleansers and a soft material such as cotton.
- 3) Keep all display components away from extreme heat and long exposure to sunlight to avoid warping and fading.
- 4) Retain all packing material. It will make re-packing much easier and will reduce the likelihood of shipping damage.



The Tool

Most Visionary Designs exhibits can be assembled with the supplied Hex Key Tool. Occasionally, a flat head screwdriver may be required.



Typical Connection

Most horizontal extrusion connections have a patented expandable lock. This lock inserts into the groove of an opposing extrusion. Tightening the lock with the Hex Key Tool expands the lock and creates a strong positive connection.



Typical Connection (cont'd)



Numbered Label

Each extrusion contains a numbered label which corresponds with setup instructions. The label is located within a groove of the extrusion (when possible). With Visionary Designs the labels contain Black numbers unless otherwise specified.



Horizontal Inline Connection (remove only one setscrew)

Remove only (1) setscrew when disassembling. Replace setscrew in extrusion after assembling it. Before packing, replace setscrew in extrusion to avoid losing it.

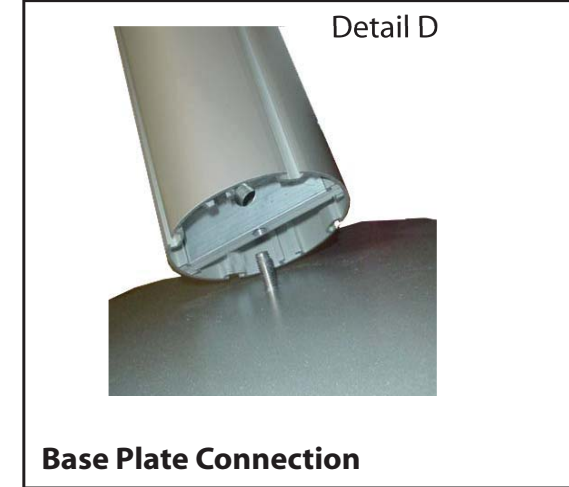

Base Plate Connection

Attach base plate to round or square vertical extrusion using the bolt provided. Be careful not to strip the threads.

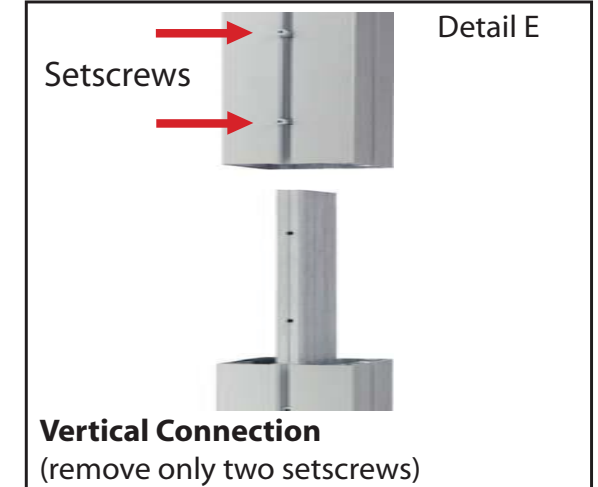

Vertical Connection
(remove only two setscrews)

When vertical extrusions are packed in portable cases rather than crates or tubs, they must be broken down into smaller sections which then require assembly.

Remove only (2) setscrews when disassembling. Replace setscrews in extrusion after assembling it. Before packing, replace setscrews in extrusion to avoid losing them.

WHEN DISASSEMBLING ALUMINUM EXTRUSION, TIGHTEN ALL SETSCREWS AND LOCKS TO PREVENT LOSS DURING SHIPPING

866.652.2100

Part Number	Qty for Step	Description
1	2	Base Plates
2	2	42" h Lower Vertical extrusion
3	2	42" h Upper Vertical extrusion
4a/4b	2	42" Lower Formed Horizontal w/ Velcro attached to Top of member
5a/5b	2	42" Middle Formed Horizontal w/ Velcro attached to Bottom of member
6	2	40" Round Oval extrusion - Workstation Counter support
7	2	19" Tapered Horizontal extrusion - Workstation Counter support

Steps

- 1) Attach 42" h Vertical extrusions [2] and 40" Round Oval extrusion - Workstation Counter supports [6] to the Oval base plates [1].
- 2) Attach 42" h Upper Vertical extrusions [3] atop of Lower Vertical extrusion [2].
- 3) Assemble all Horizontal extrusions [4a to 4b and 5a to 5b].
- 4) Attach 19" Tapered Horizontal extrusion - Workstation Counter support [7] to 84" h Vertical [2/3].
- 5) Attach 84" Lower Horizontal assemblies [4a/4b] between Vertical assemblies [2/3] as shown.
note: Velcro on Lower Horizontals must face UP.
- 6) Attach 84" Upper Horizontal assemblies [5a/5b] between Vertical assemblies [2/3] as shown.
note: Velcro on Upper Horizontals must face DOWN.
- 7) Place Counter tops with Thumbscrews onto horizontal extrusion [7].

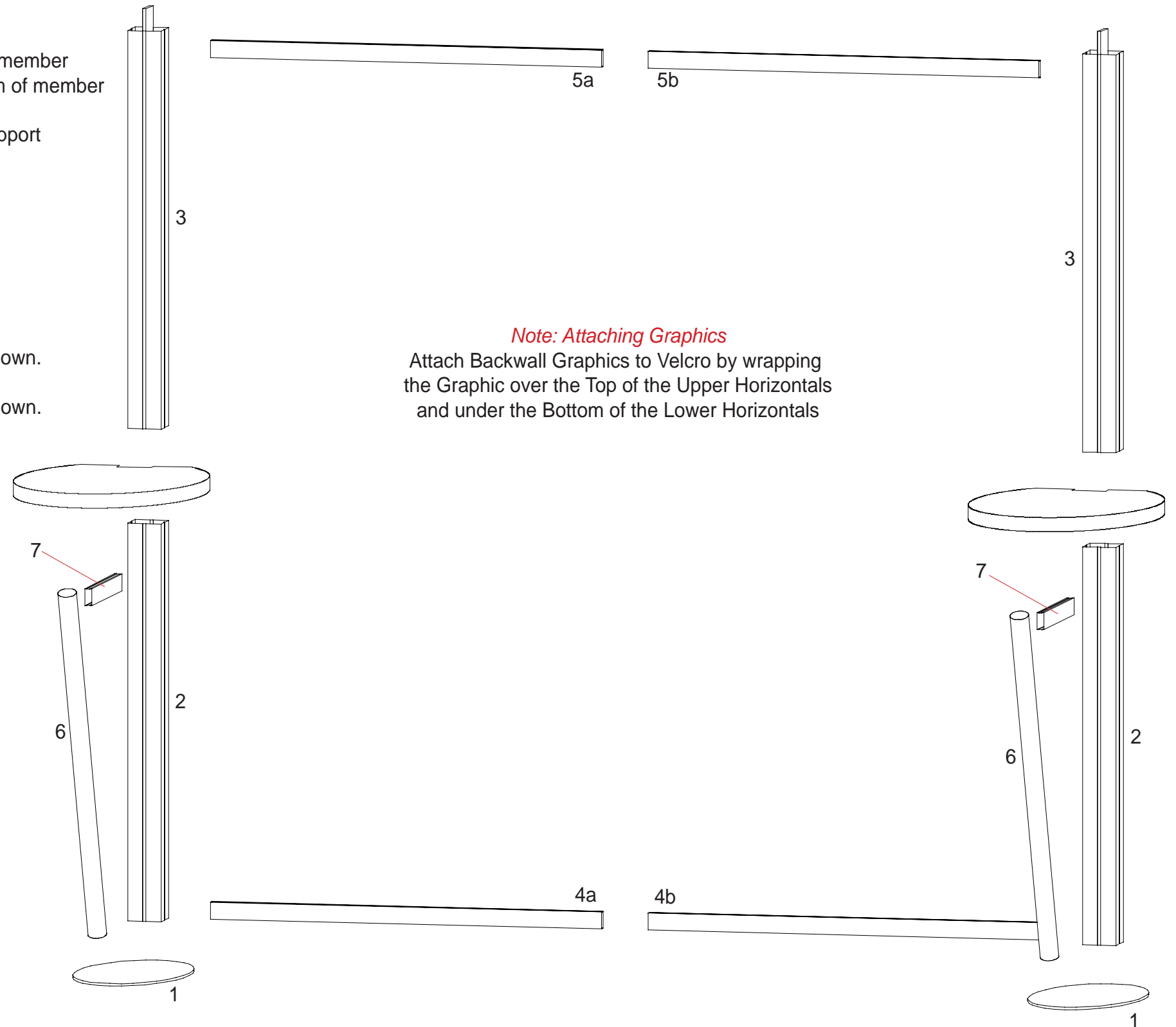

Note: Attaching Graphics

Attach Backwall Graphics to Velcro by wrapping the Graphic over the Top of the Upper Horizontals and under the Bottom of the Lower Horizontals

WHEN DISASSEMBLING ALUMINUM EXTRUSION, TIGHTEN ALL SETSCREWS AND LOCKS TO PREVENT LOSS DURING SHIPPING

866.652.2100

Wing Attachment

Slide A10 Clamp into groove of square extrusion.

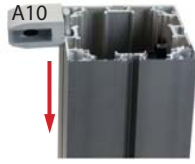

When desired location is found, tighten set screw to secure.



Set-Screw

Tighten black plastic set screw to secure Wing in place.



Black Plastic Set-screw

Light Connection

Attach Lights to Backwall where desired and tighten in place.

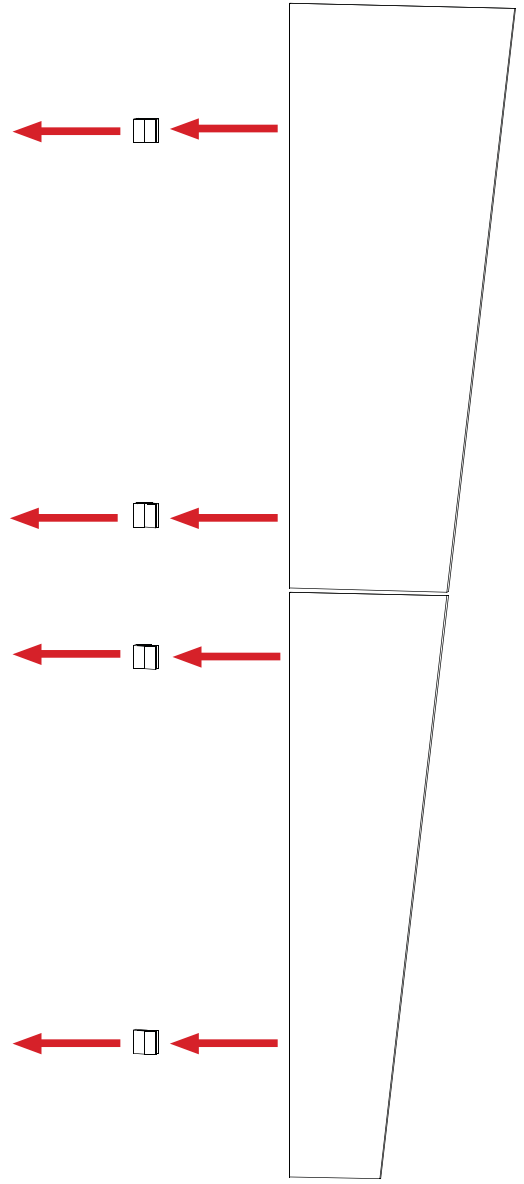
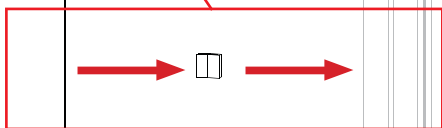
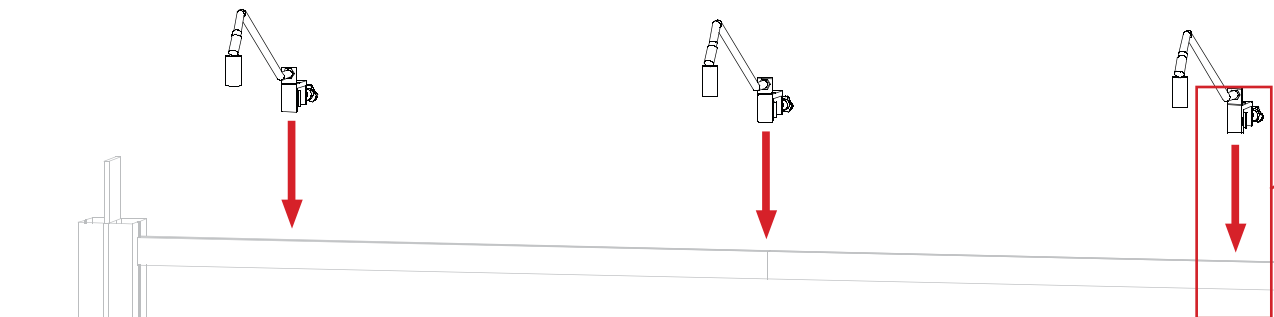
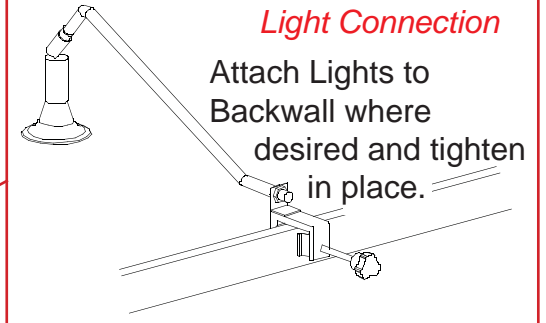

WHEN DISASSEMBLING ALUMINUM EXTRUSION, TIGHTEN ALL SETSCREWS AND LOCKS TO PREVENT LOSS DURING SHIPPING

Item	Quantity	Description
A	1	39" Round formed extrusion
AB	1	39" Round formed extrusion
B	1	39" Round fomred extrusion
C	1	39" Round formed extrusion
CD	1	39" Round formed extrusion
D	1	39" Round formed extrusion
E	2	14" Round extrusion
F	1	14" Round extrusion

Steps:

- 1) Connect 39" (A) round formed extrusion to 39" (A) round formed extrusion.
- 2) Connect 39" (B) round formed extrusion to 39" (B) round formed extrusion.
- 3) Connect 39" (C) round formed extrusion to 39" (C) round formed extrusion.
- 4) Connect 39" (D) round formed extrusion to 39" (D) round formed extrusion.
- 5) Connect (A) round formed extrusion and (D) round formed extrusion to 14" (E) extrusion.
- 6) Connect (B) round formed extrusion and (C) round formed extrusion to 14" (E) extrusion.
- 7) Connect (AB) round formed extrusion and (CD) round formed extrusion to 14" (F) extrusion.
- 8) Attach Canopy Assembly to Vertical extrusions with Canopy attachments.

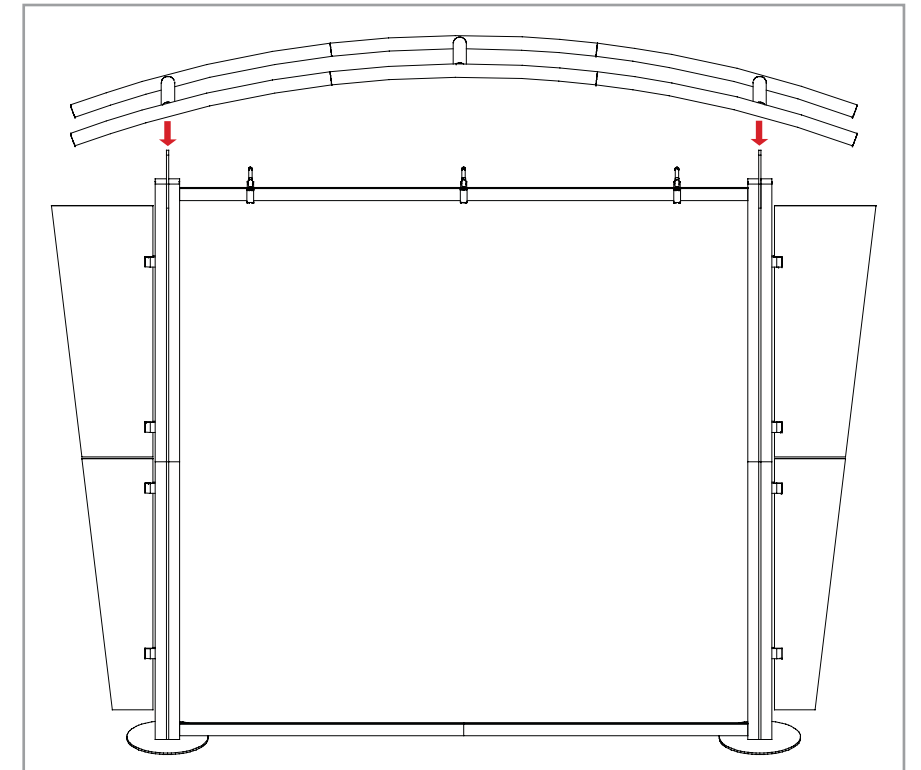
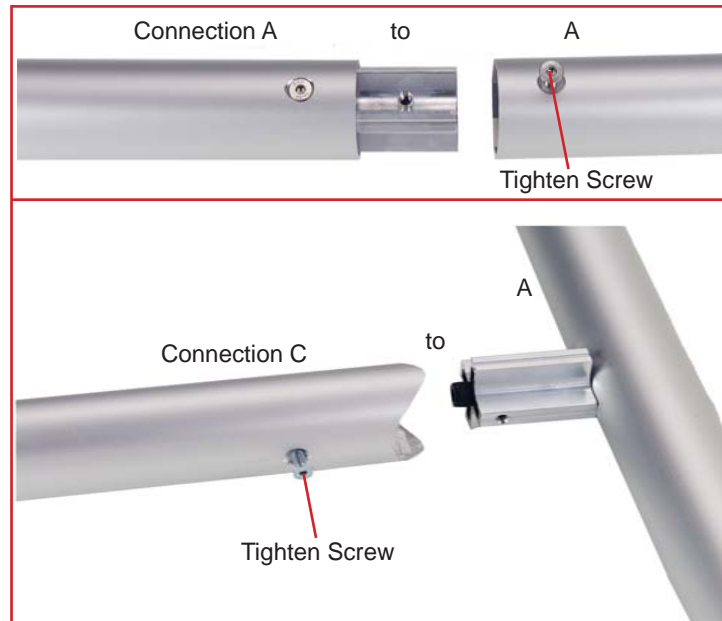
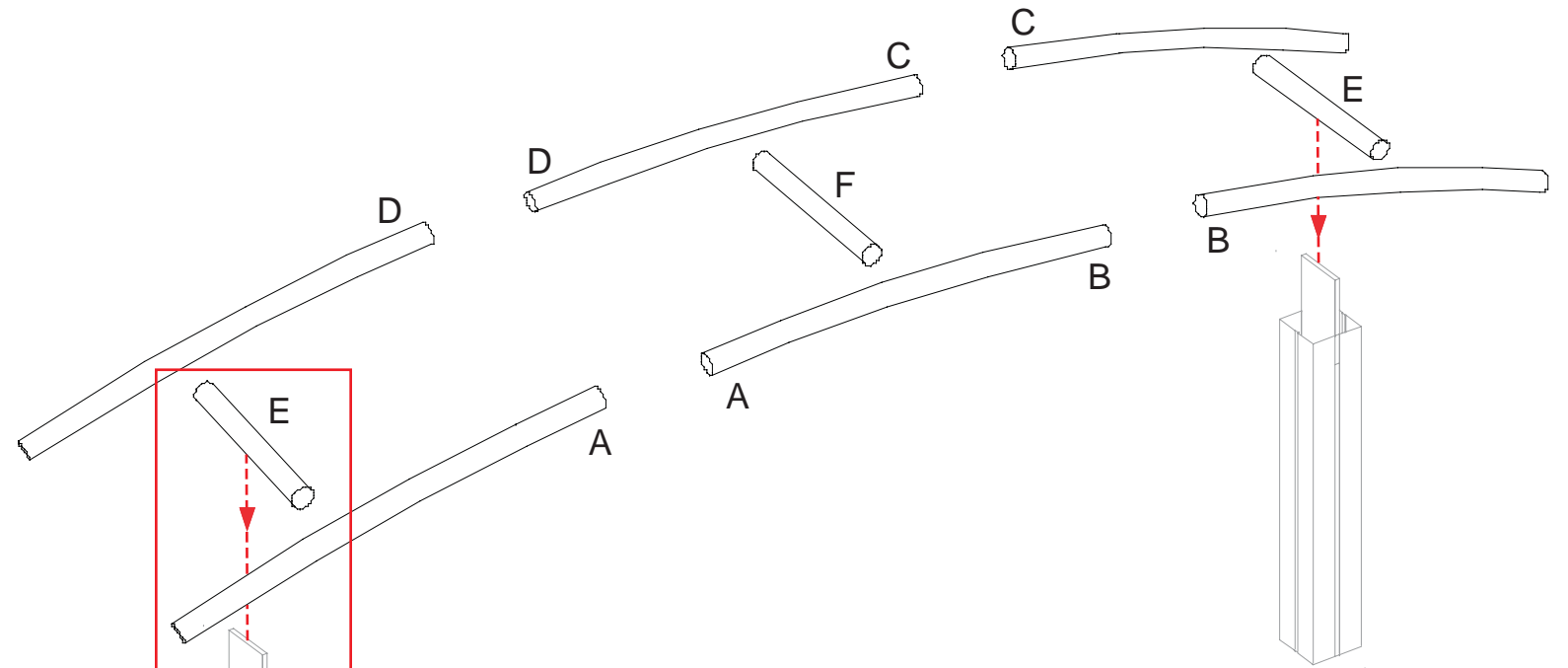

WHEN DISASSEMBLING ALUMINUM EXTRUSION, TIGHTEN ALL SETSCREWS AND LOCKS TO PREVENT LOSS DURING SHIPPING

866.652.2100

Item	Quantity	Description
8	1	38" h Round Vertical Extrusion
9	1	38" h Round Vertical Extrusion
10	1	38" h Round Vertical Extrusion w/ Hinges
11	1	38" h Round Vertical Extrusion w/ Door Stopper
12	2	33" Curved Horizontal Extrusion
13	2	12" Horizontal Extrusion
14	2	9.215" Horizontal Extrusion
15	2	12" Horizontal Extrusion
16	1	34.418" Vertical Extrusion

Steps:

- 1) Attach lower horizontal extrusions [12, 13, 14 and 15] between vertical extrusions [8, 9, 10 and 11].
- 2) Attach vertical extrusion [16] to horizontal extrusion [12], leave loose, placing inserts as indicated, then tighten setscrews to secure vertical in place.
- 3) Place remaining inserts and door in place.
- 4) Attach upper horizontal extrusions [12, 13, 14 and 15] between vertical extrusions [8, 9, 10 and 11].
- 5) Velcro internal shelf supports to inside assembled pedestal
- 6) Set internal shelf atop shelf supports
- 7) Set counter top on assembled pedestal.
- 8) Attach plex shelf to counter top using stand-offs.

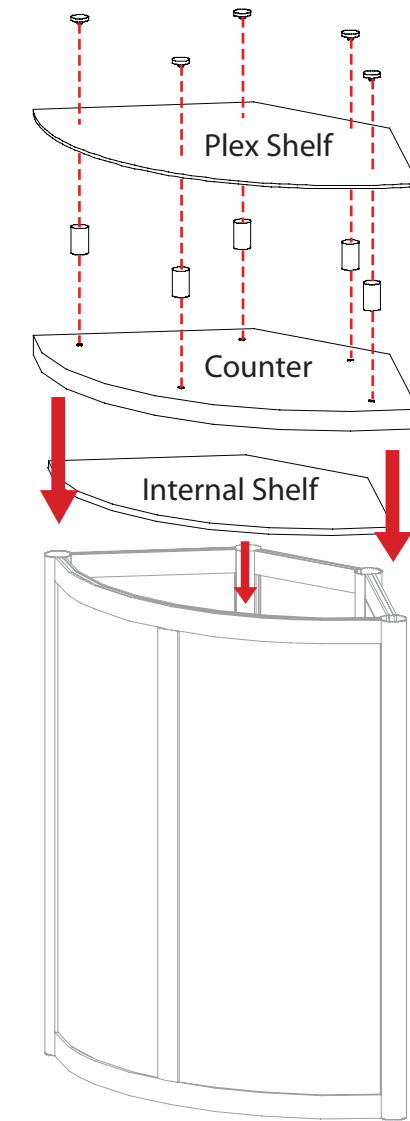
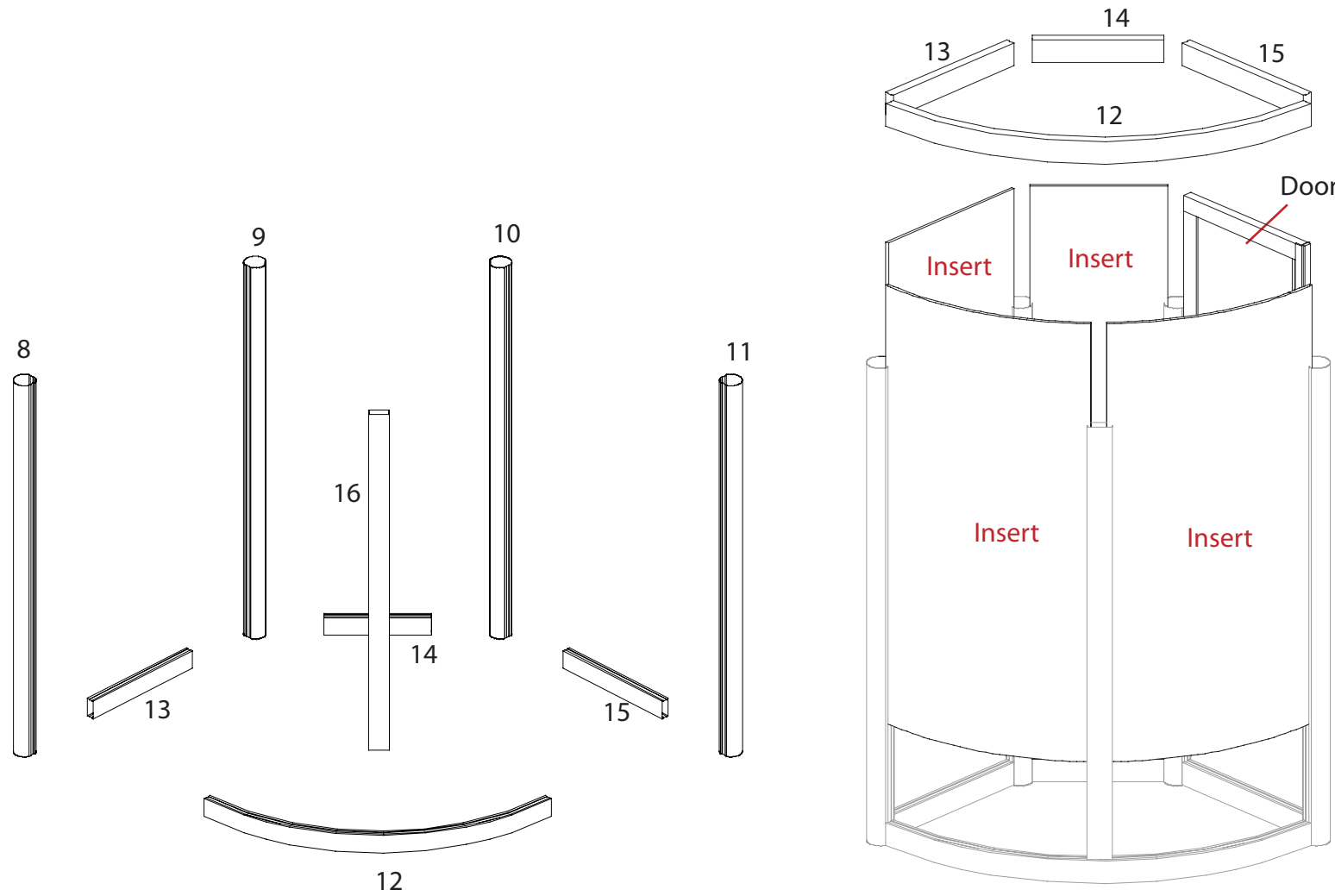
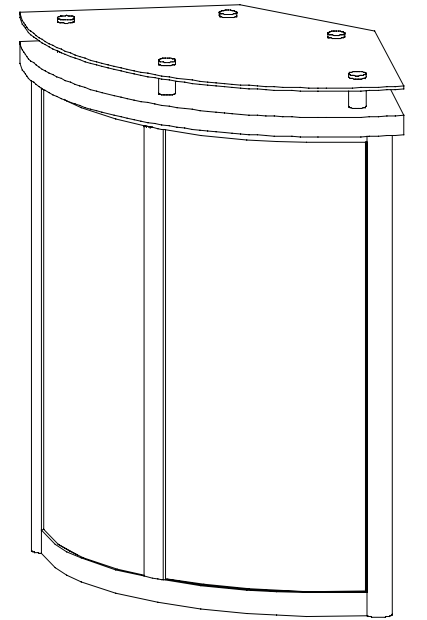

Place counter atop assembled pedestal base. Attach top shelf to counter using stand-offs.



WHEN DISASSEMBLING ALUMINUM EXTRUSION, TIGHTEN ALL SETSCREWS AND LOCKS TO PREVENT LOSS DURING SHIPPING

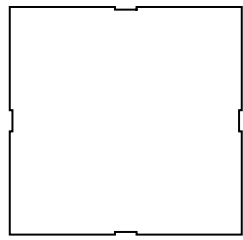

42" Square Extrusion

Qty. : 4

Located in Case : _____

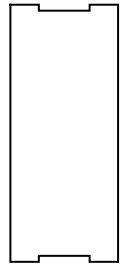

42" Extrusion

Qty. : 4

Located in Case : _____

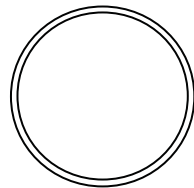

Tapered Counter Support

Qty. : 2

Located in Case : _____

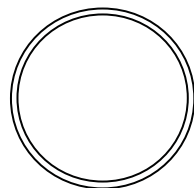

Curved Standard Canopy Extrusion

Qty. : 6

Located in Case : _____

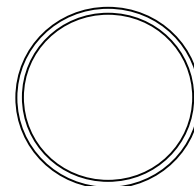

Standard Canopy Center Extrusion

Qty. : 3

Located in Case : _____

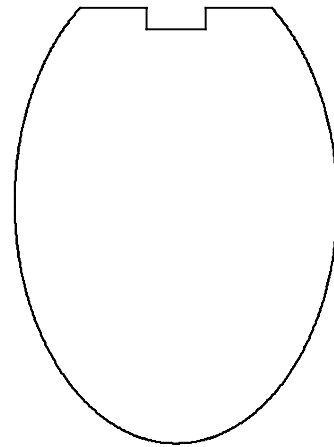

Workstation Counter Top

Qty. : 2

Located in Case : _____

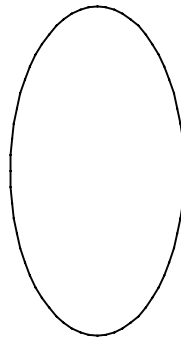

Ocal Base Plate

Qty. : 2

Located in Case : _____

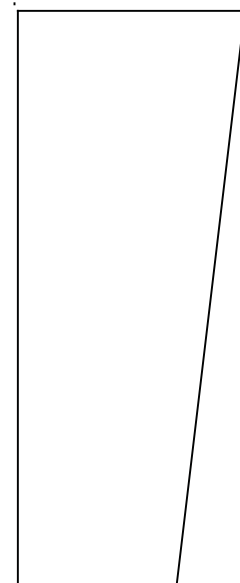

Upper Wing panel

Qty. : 2

Located in Case : _____

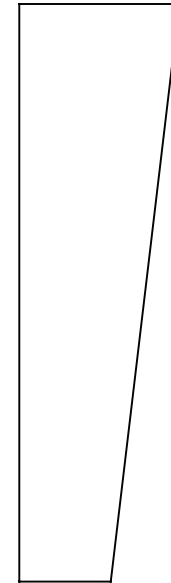

Lower Wing Panel

Qty. : 2

Located in Case : _____

Additional Accessories:

_____ in case _____

_____ in case _____

_____ in case _____

_____ in case _____

_____ in case _____



A10 Clamps for Wings

Qty. : 8

Located in Case : _____

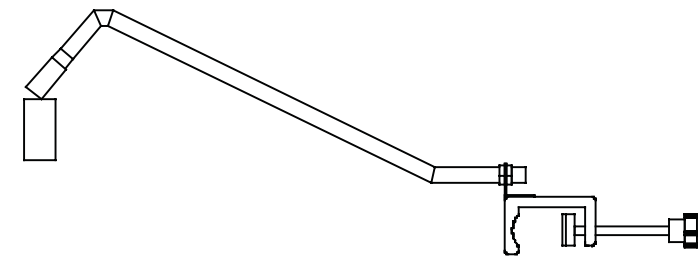

Halogen Light

Qty. : 3

Located in Case : _____

WHEN DISASSEMBLING ALUMINUM EXTRUSION, TIGHTEN ALL SETSCREWS AND LOCKS TO PREVENT LOSS DURING SHIPPING

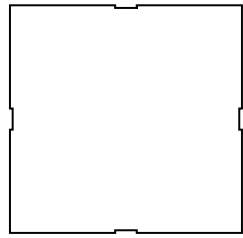

42" Square Extrusion

Qty. : 4

Located in Case : _____

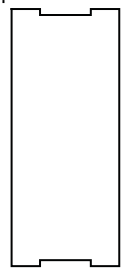

42" Extrusion

Qty. : 4

Located in Case : _____

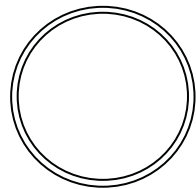

Tapered Counter Support

Qty. : 2

Located in Case : _____

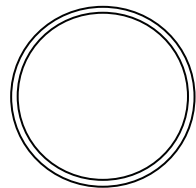

Curved Standard Canopy Extrusion

Qty. : 6

Located in Case : _____

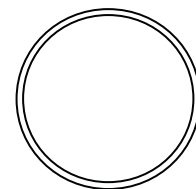

Standard Canopy Center Extrusion

Qty. : 3

Located in Case : _____

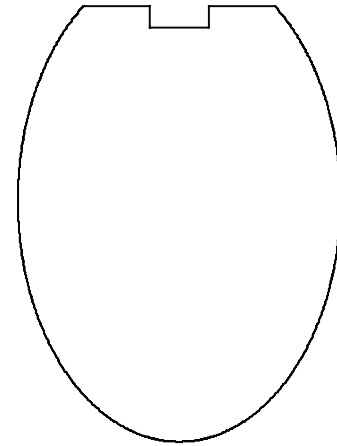

Workstation Counter Top

Qty. : 2

Located in Case : _____

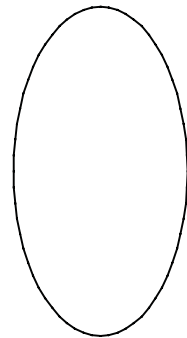

Ocal Base Plate

Qty. : 2

Located in Case : _____

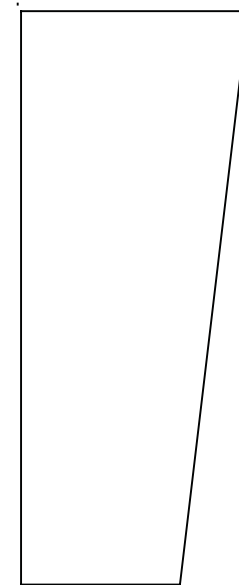

Upper Wing panel

Qty. : 2

Located in Case : _____

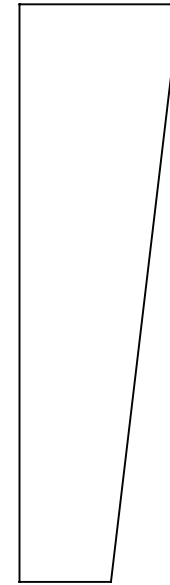

Lower Wing Panel

Qty. : 2

Located in Case : _____

Additional Accessories:

_____ in case _____

_____ in case _____

_____ in case _____

_____ in case _____

_____ in case _____



A10 Clamps for Wings

Qty. : 8

Located in Case : _____

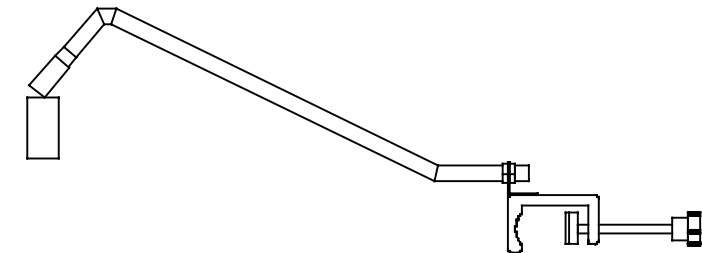

Halogen Light

Qty. : 3

Located in Case : _____

WHEN DISASSEMBLING ALUMINUM EXTRUSION, TIGHTEN ALL SETSCREWS AND LOCKS TO PREVENT LOSS DURING SHIPPING

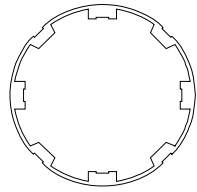

38"H Round Extrusion

Qty. : 4

34.418"H Extrusion

Qty. : 1



12"W Extrusion

Qty. : 4

9.215"W Extrusion

Qty. : 2

33"W Curved Extrusion

Qty. : 2



Shelf Support

Qty. : 4



16.042"W x 34.855"H
Laminated Insert

Qty. : 2

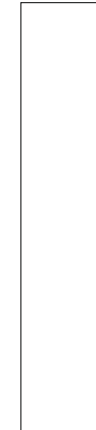

12.4375"W x 34.855"H
Laminated Insert

Qty. : 1



9.6525"W x 34.855"H
Laminated Insert

Qty. : 1

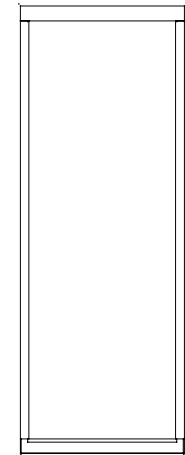

Locking Door

Qty. : 1

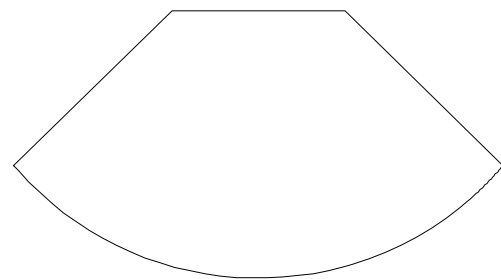

Internal Shelf

Qty. : 1

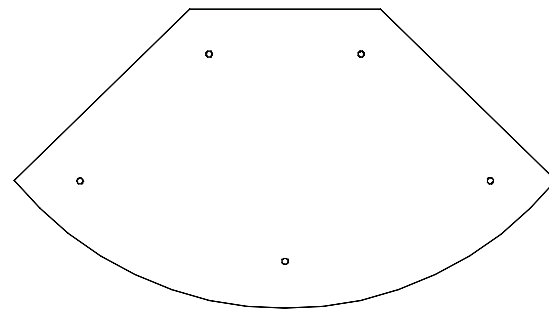

Counter Top

Qty. : 1

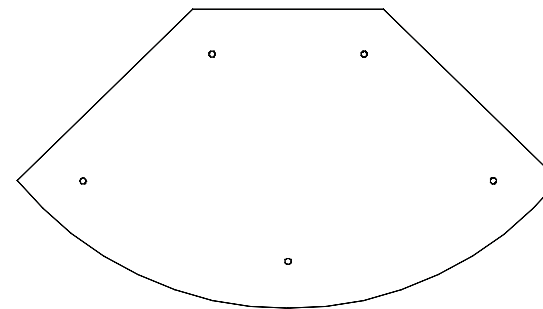

Plex Shelf

Qty. : 1

Additional Accessories:

Setup Hardware

WHEN DISASSEMBLING ALUMINUM EXTRUSION, TIGHTEN ALL SETSCREWS AND LOCKS TO PREVENT LOSS DURING SHIPPING