

euro It | HYBRIDS

866.652.2100

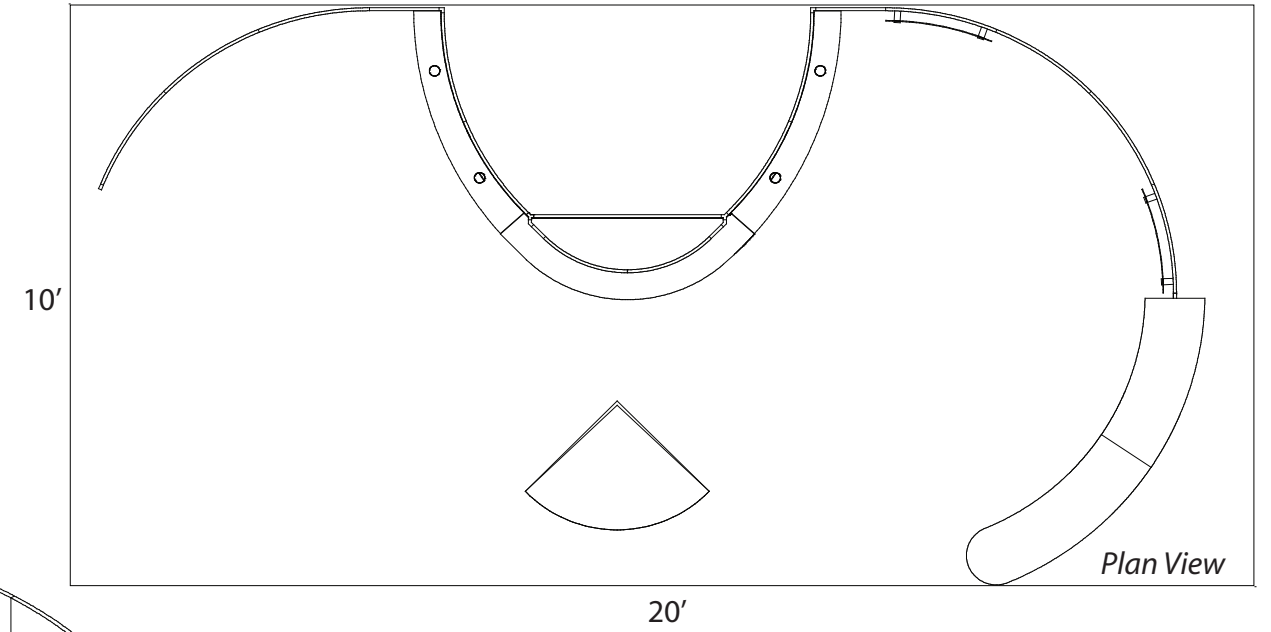
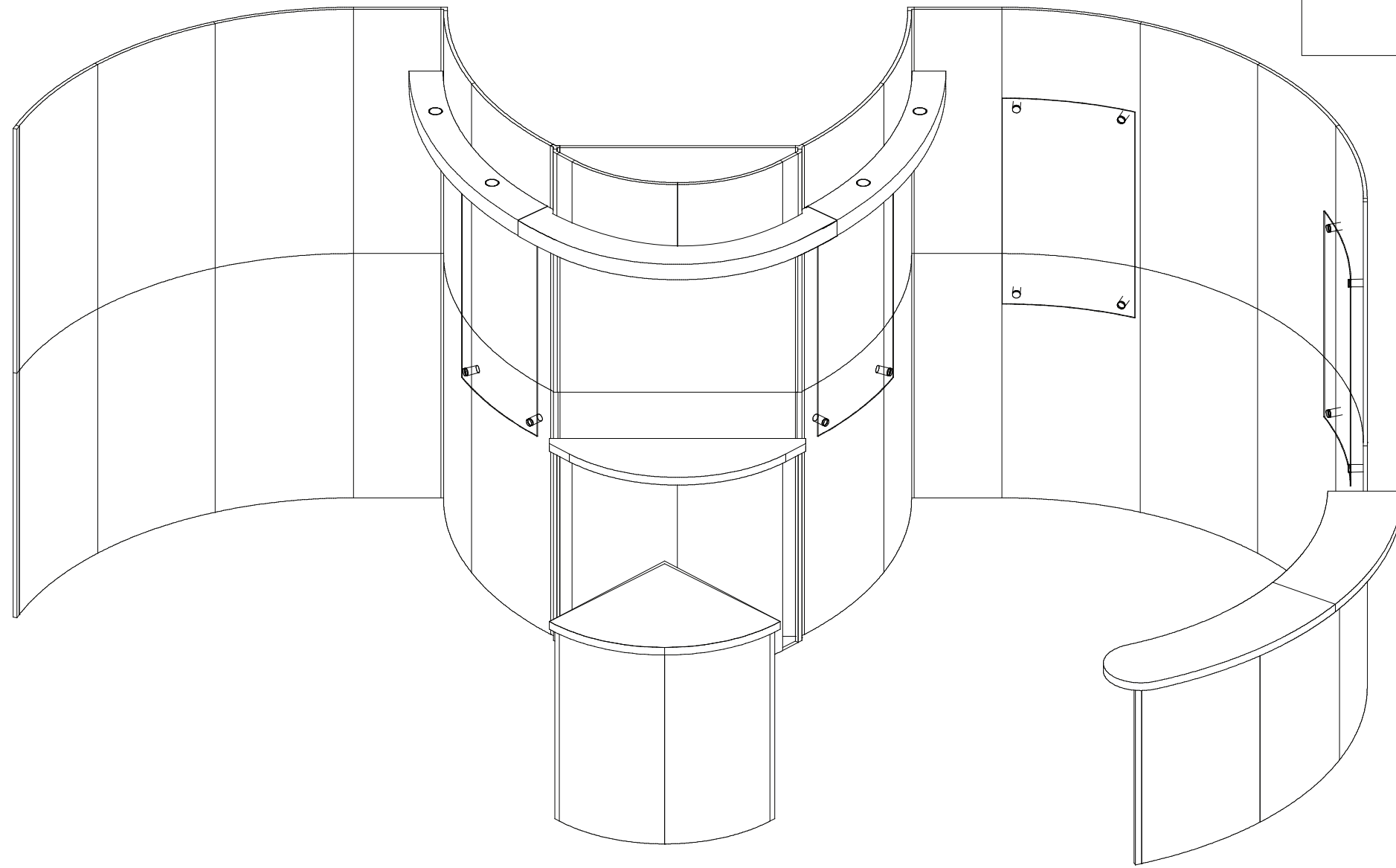

euro It | HYBRIDS

Euro LT Hybrids General Setup Instructions

Using Your Setup Instructions

The Euro LT Hybrids Setup Instructions are created specifically for your configuration. They are laid out sequentially in levels, including exploded views, and a logical series of detailed steps to assemble the main structure and components. We encourage you to study the instructions **before** attempting to assemble your exhibit.

Cleaning and Packing Your Display

- 1) When cleaning laminate countertops or panels use mild cleansers and a soft material such as cotton.
- 2) Keep all display components away from extreme heat and long exposure to sunlight to avoid warping and fading.
- 3) Retain all packing material. It will make re-packing much easier and will reduce the likelihood of shipping damage.

Level 1 = Blue
 Level 2 = Red
 Level 3 = Green
 Level 4 = Black

Color Code

The top clip is color coded to distinguish the level. The color coded clip also contains the numbered label

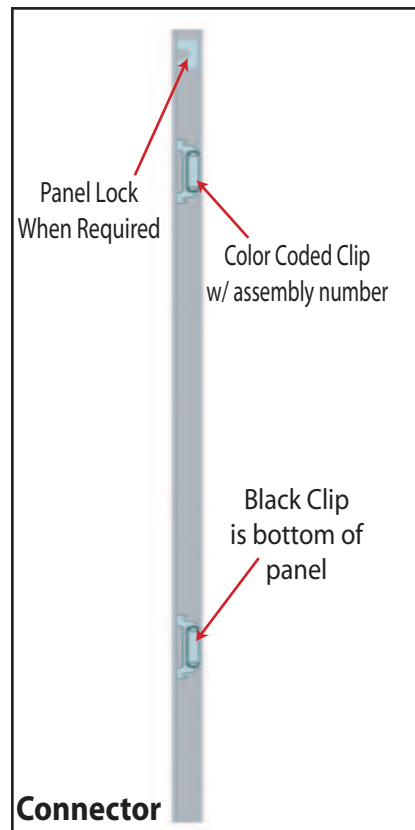

Each component has 2 clips, the lower clip is ALWAYS black..

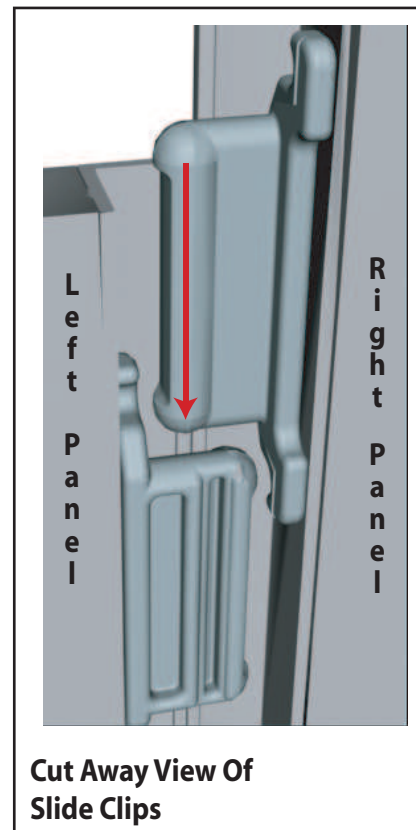

Components connect together by aligning them and sliding downward connecting clips together.

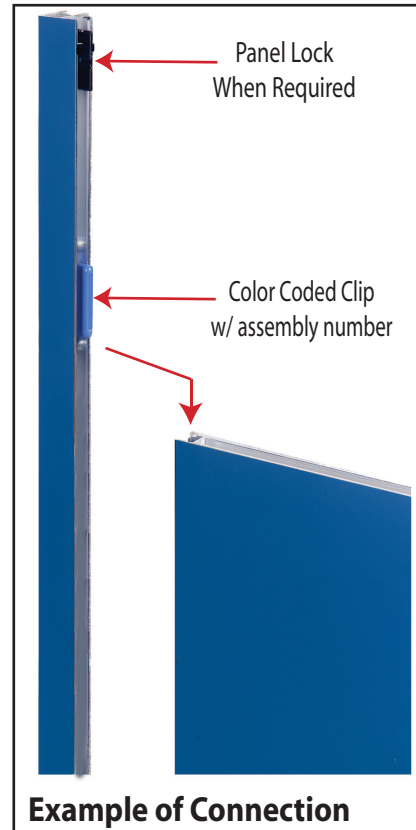

Configurations are assembled from left to right, usually starting with #1 and following the numbered sequence.

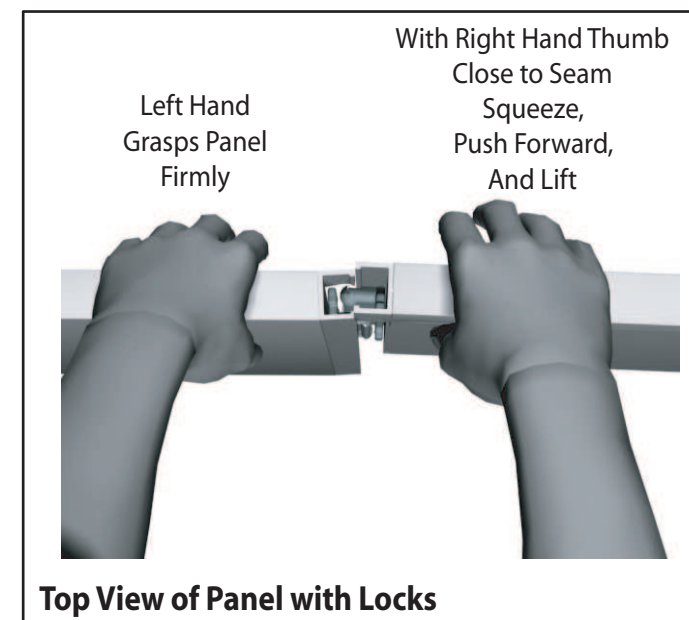

The first level of components contains panel locks that are located at the top of the panel for extra stability and a seamless connection. When disassembling panels, twist top connection slightly and lift right panel upward.

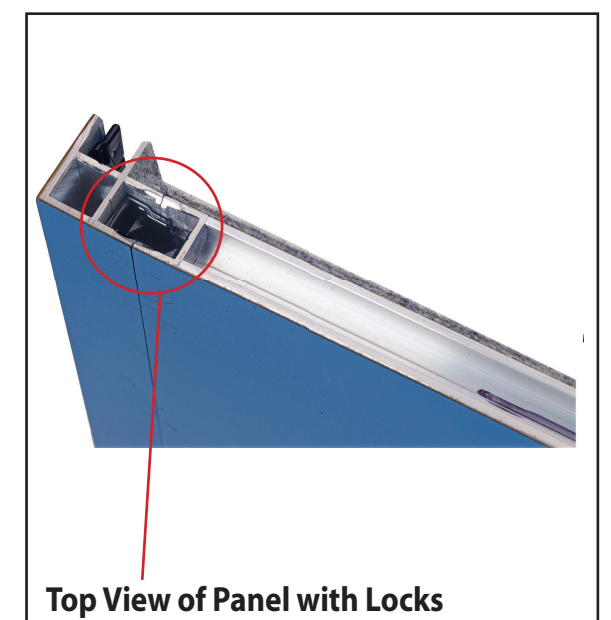

866.652.2100

Item Number	Description
1	47.5”h End Cap
2	57.5”r x 47.5”h Curve Panel
3	57.5”r x 47.5”h Curve Panel
4	57.5”r x 47.5”h Curve Panel
5	14.125”w x 47.5”h Flat Panel
6	47.5”h 90° Connector
7	57.5”r x 47.5”h Curve Panel
8	57.5”r x 47.5”h Curve Panel
9	47.5”h 3-Way Connector
10	38”w x 47.5”h Flat Panel
11	38”h 135° Connector
12	2.9”w x 38”h Flat Panel
13	23”r x 38”h Curve Panel
14	23”r x 38”h Curve Panel
15	2.9”w x 38”h Flat Panel
16	38”h 135° Connector
17	47.5”h 3-Way Connector
18	57.5”r x 47.5”h Curve Panel
19	57.5”r x 47.5”h Curve Panel
20	47.5”h 90° Connector
21	14.125”w x 47.5”h Flat Panel
22	57.5”r x 47.5”h Curve Panel
23	57.5”r x 47.5”h Curve Panel
24	57.5”r x 47.5”h Curve Panel
25	57.5”r x 47.5”h Curve Panel
26	57.5”r x 38”h Curve Panel
27	57.5”r x 38”h Curve Panel
28	57.5”r x 38”h Curve Panel
29	38”h End Cap
30	23”w x 38”h Flat Panel
31	38”h 90° Connector
32	23”r x 38”h Curve Panel
33	23”r x 38”h Curve Panel
34	38”h 90° Connector
35	23”w x 38”h Door Panel
36	38”h 90° Connector

Steps:
 1) Assemble by starting at panel #1* and continue in numerical order.

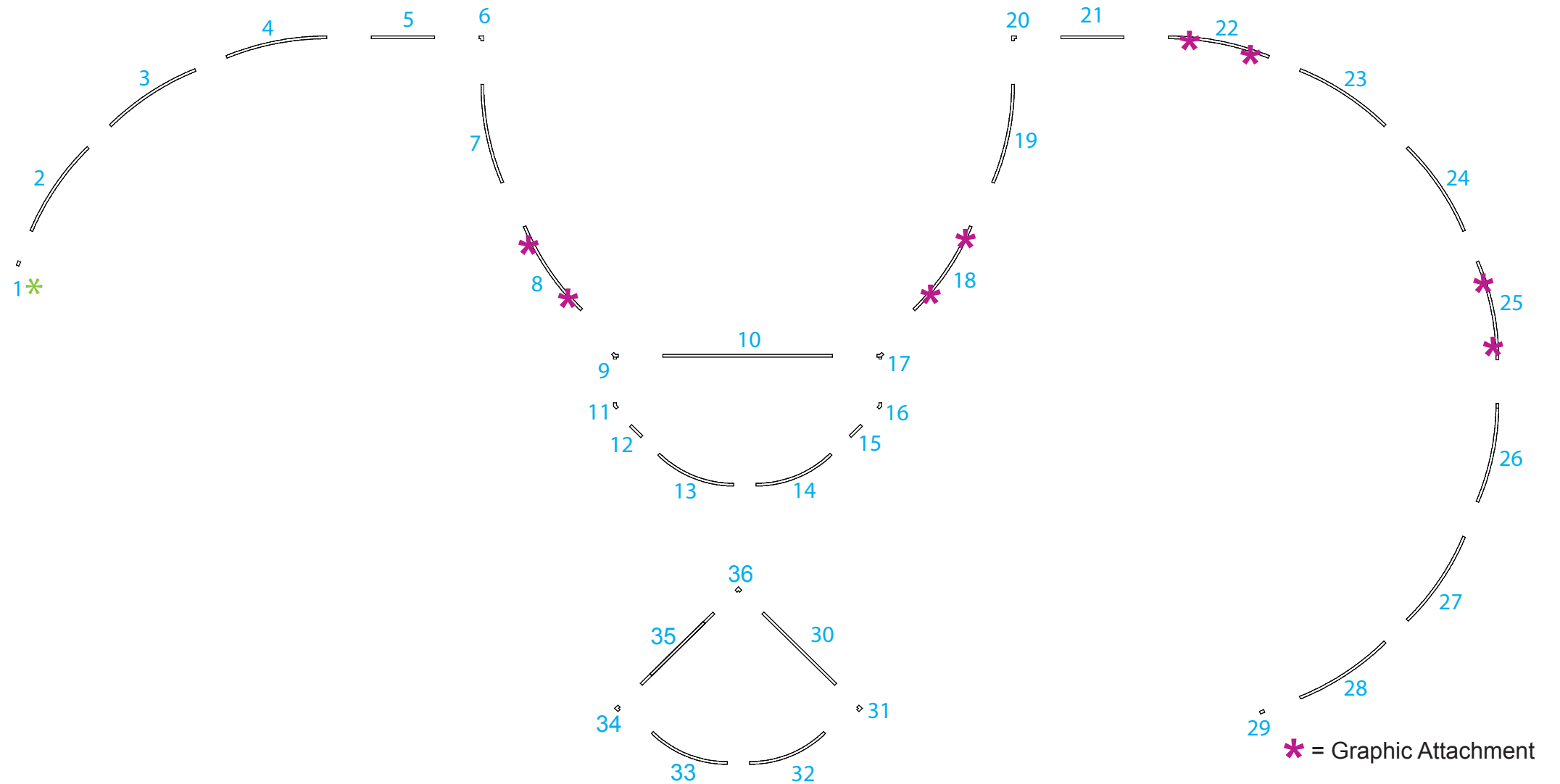
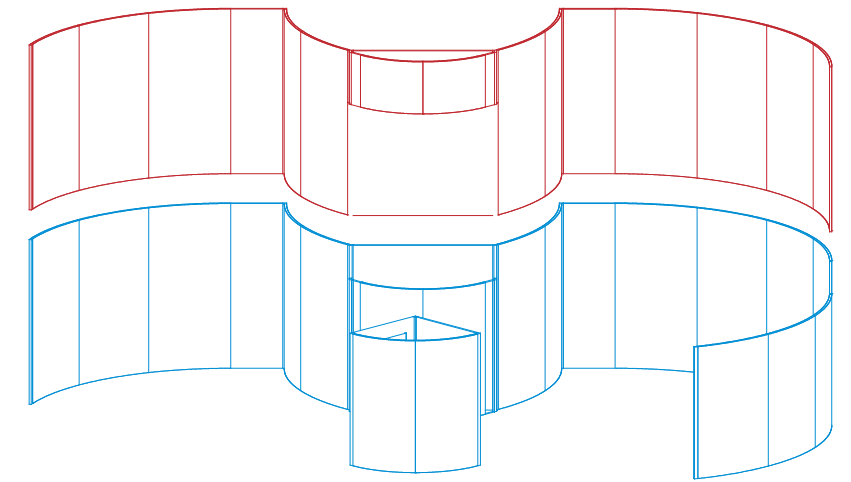

* = Graphic Attachment

866.652.2100

Item Number	Description
1	47.5" h End Cap
2	57.5" r x 47.5" h Curve Panel
3	57.5" r x 47.5" h Curve Panel
4	57.5" r x 47.5" h Curve Panel
5	14.125" w x 47.5" h Flat Panel
6	47.5" h 90° Connector
7	57.5" r x 47.5" h Curve Panel
8	57.5" r x 47.5" h Curve Panel
9	47.5" h 3-Way Connector
10	38" w x 47.5" h Flat Panel
11	15" h 135° Connector
12	2.9" w x 15" h Flat Panel
13	23" r x 15" h Curve Panel
14	23" r x 15" h Curve Panel
15	2.9" w x 15" h Flat Panel
16	23" h 135° Connector
17	47.5" h 3-Way Connector
18	57.5" r x 47.5" h Curve Panel
19	57.5" r x 47.5" h Curve Panel
20	47.5" h 90° Connector
21	14.125" w x 47.5" h Flat Panel
22	57.5" r x 47.5" h Curve Panel
23	57.5" r x 47.5" h Curve Panel
24	57.5" r x 47.5" h Curve Panel
25	57.5" r x 47.5" h Curve Panel
26	47.5" h End Cap

- Steps:
- 1) Assemble backwall by starting at panel #1* and continue in numerical order.
 - 2) Assemble header pieces together #11 thru 16.
 - 3) Connect assembled header to backwall as shown.

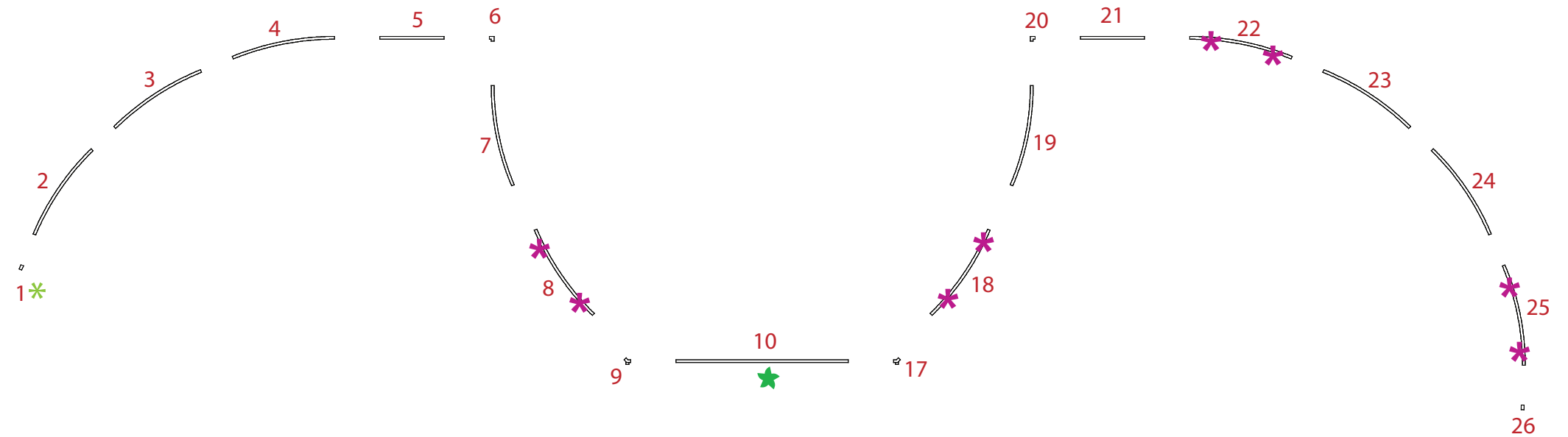
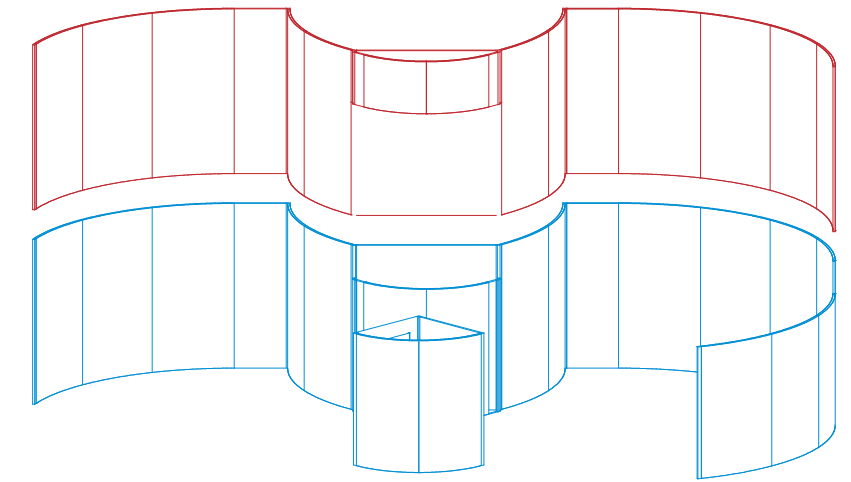

★ = Monitor Mount Attachment
 * = Graphic Attachment

Steps:

- 1) Set counters atop assembled bases as shown.
- 2) Attach graphics to assembled backwall using stand-offs.
- 3) Attach counter supports to top of curve backwall using supplied bolts, see counter attachment detail.
- 4) Set 2-piece counter atop counter supports.
- 5) Apply rollable graphic to backwall as indicated.

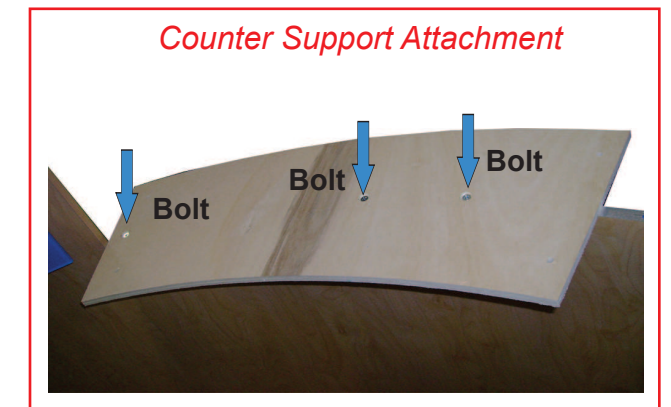
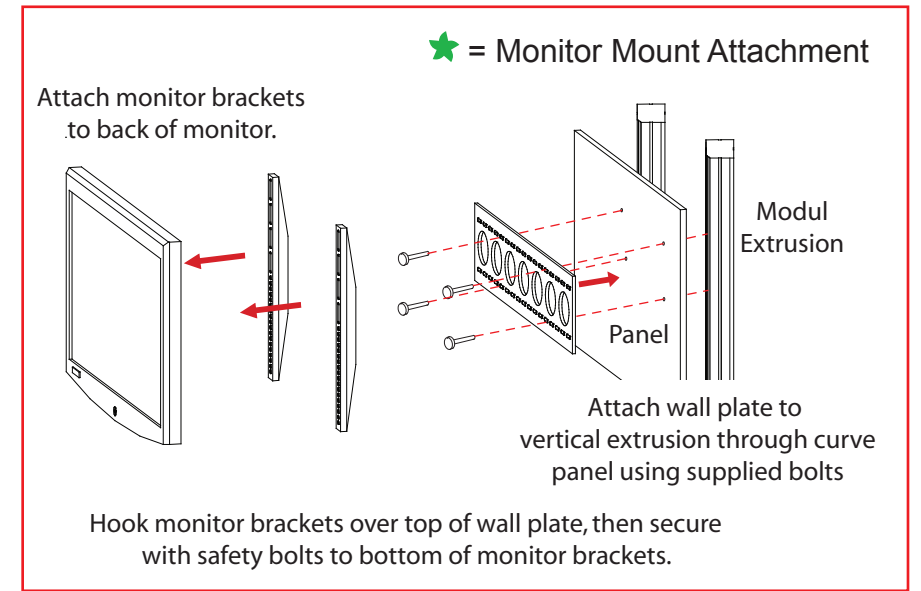
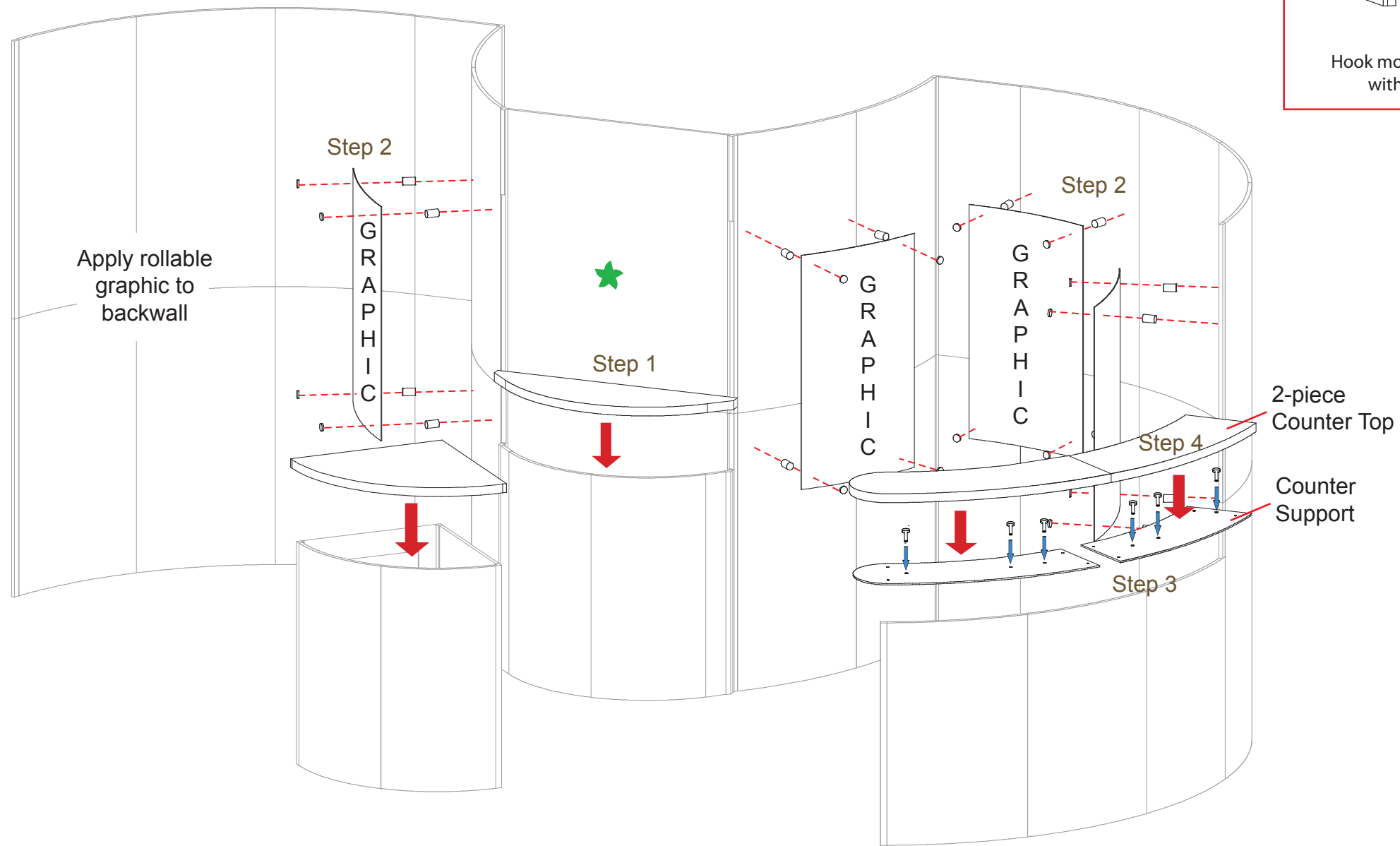

Steps:

- 1) Attach side ceiling pieces to assembled backwall using thumbscrews as shown.
- 2) Attach center ceiling piece to assembled backwall using thumbscrews as shown.
- 3) Connect ceiling pieces together using provided bolts and wing nuts.

Ceiling Connection

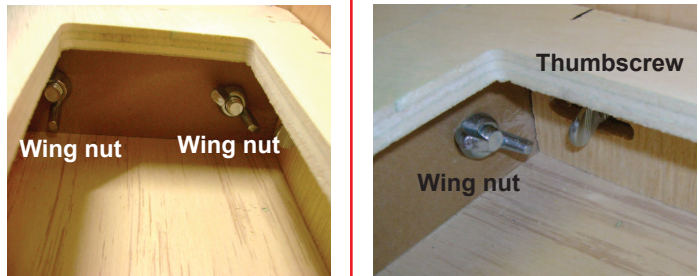

Wing nut Wing nut

Thumbscrew

Wing nut

Use provided bolts and wing nuts to connect ceiling pieces together.

Attach ceiling to backwall using provided thumbscrews

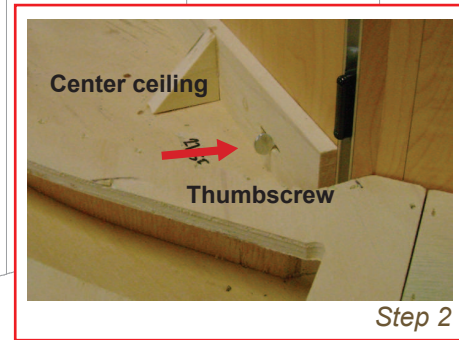
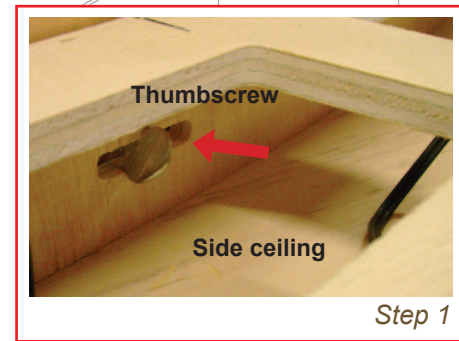
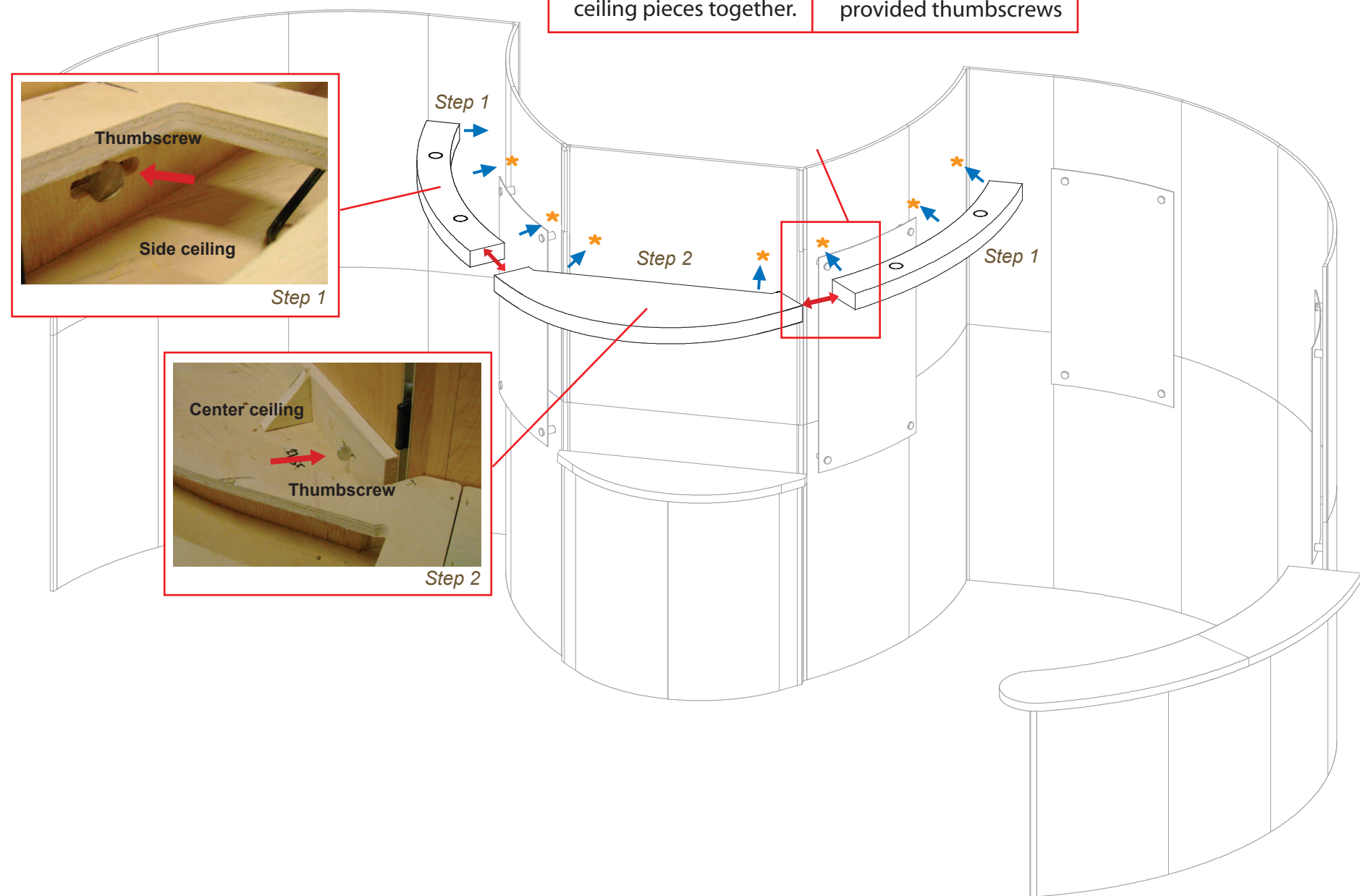

Steps:

- 1) Connect header pieces together #11 thru #16.
- 2) Attach assembled header to backwall.

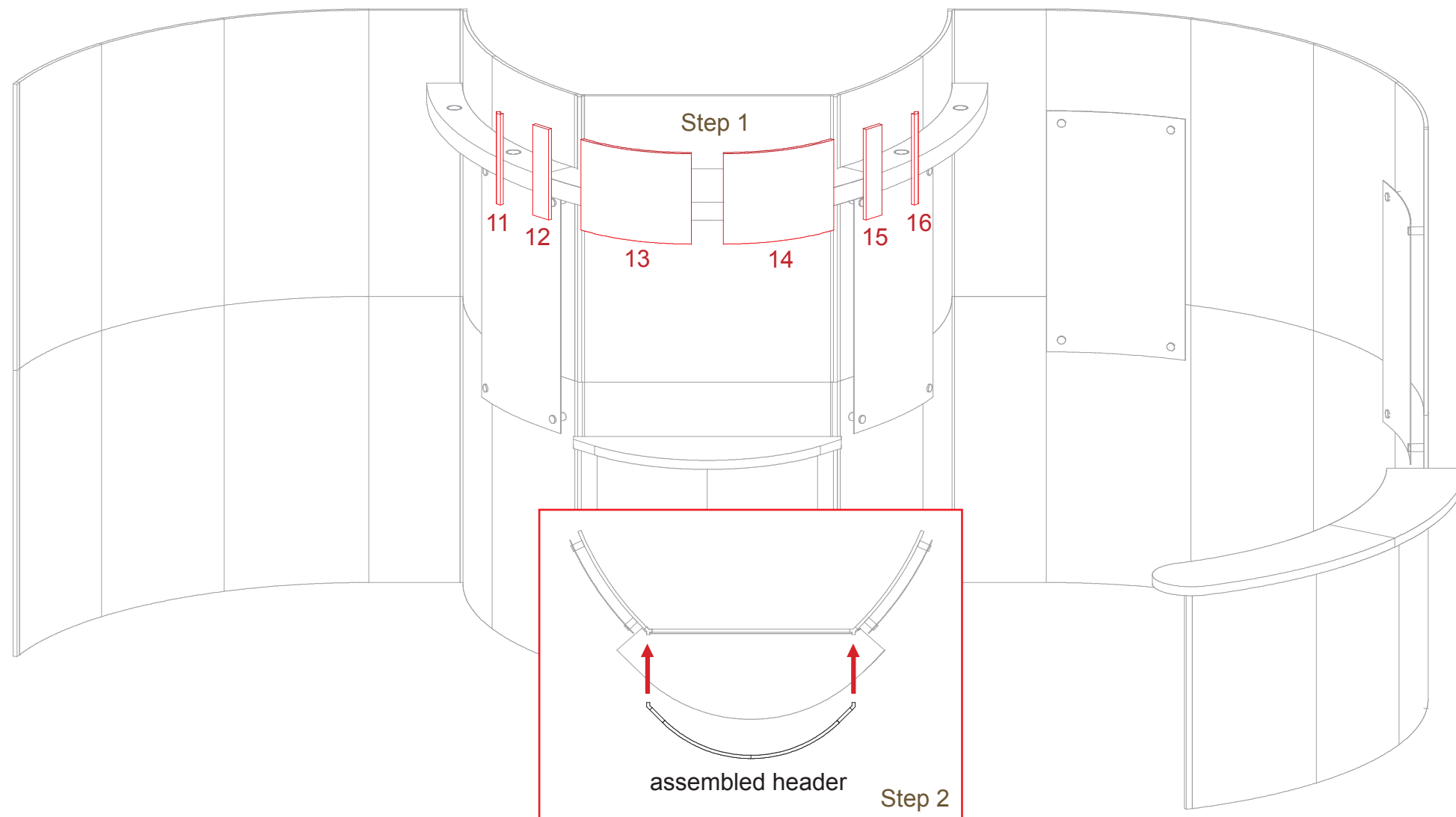

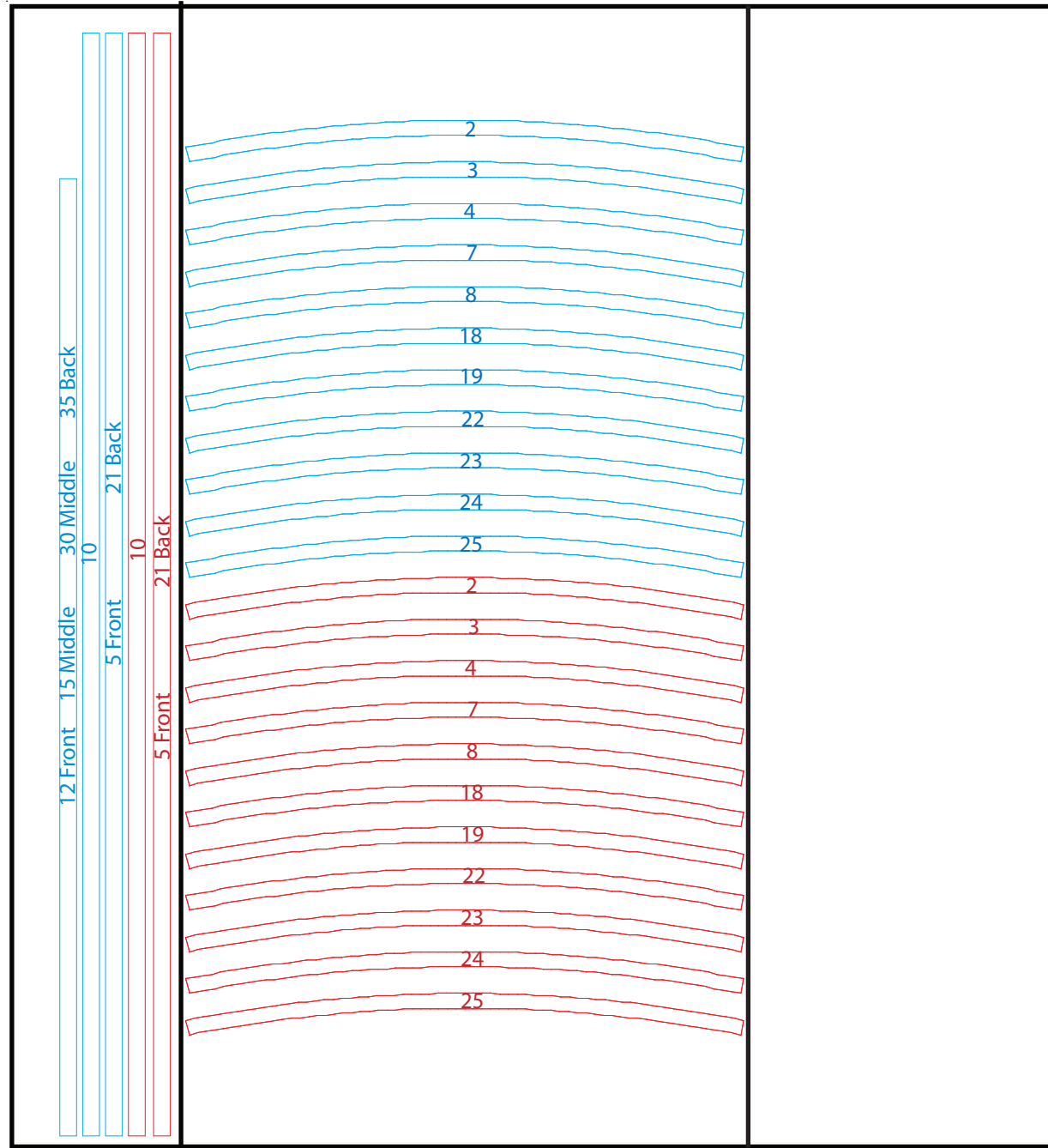

Jumbo Tub 1



Jumbo Tub 1 - Front View

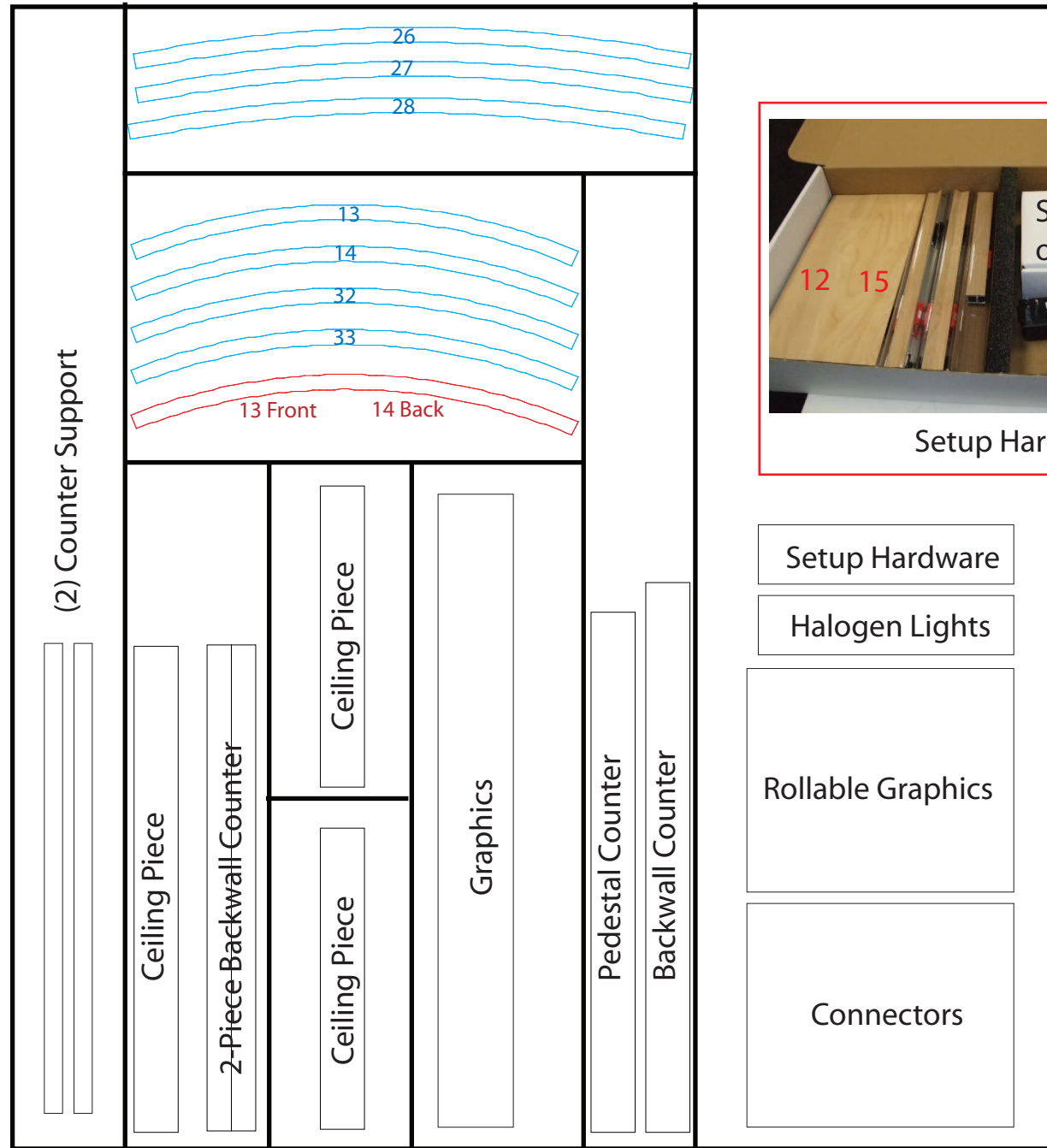

Setup Hardware



Jumbo Tub 2 - Front View

Jumbo Tub 2