

euro It | HYBRIDS

866.652.2100

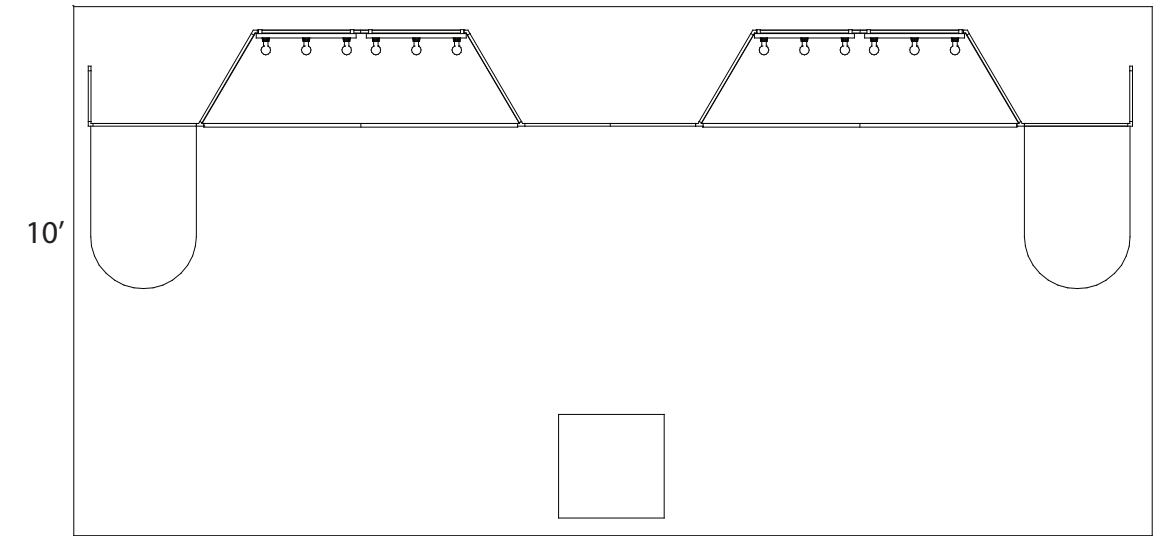

20'

Plan View

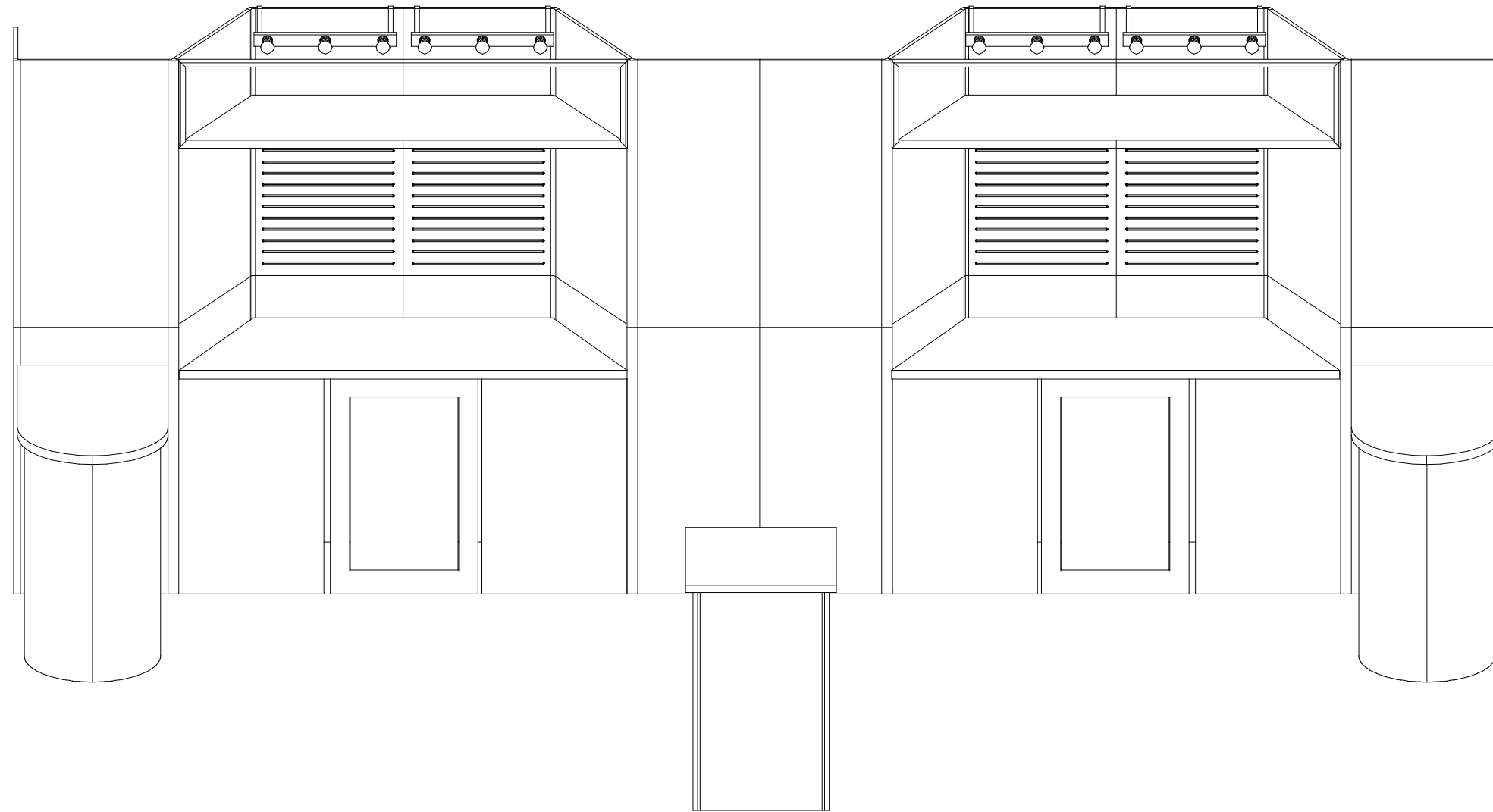

euro lt | HYBRIDS

Euro LT Hybrids General Setup Instructions

Using Your Setup Instructions

The Euro LT Hybrids Setup Instructions are created specifically for your configuration. They are laid out sequentially in levels, including exploded views, and a logical series of detailed steps to assemble the main structure and components. We encourage you to study the instructions **before** attempting to assemble your exhibit.

Cleaning and Packing Your Display

- 1) When cleaning laminate countertops or panels use mild cleansers and a soft material such as cotton.
- 2) Keep all display components away from extreme heat and long exposure to sunlight to avoid warping and fading.
- 3) Retain all packing material. It will make re-packing much easier and will reduce the likelihood of shipping damage.

Level 1 = Blue
 Level 2 = Red
 Level 3 = Green
 Level 4 = Black

Color Code

The top clip is color coded to distinguish the level. The color coded clip also contains the numbered label

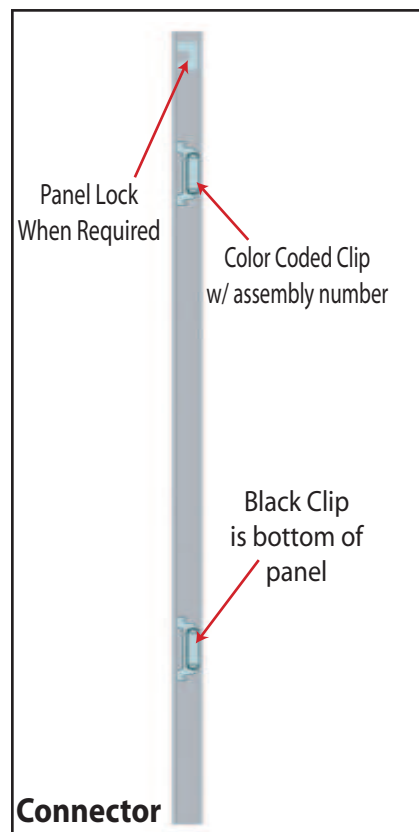

Each component has 2 clips, the lower clip is ALWAYS black..

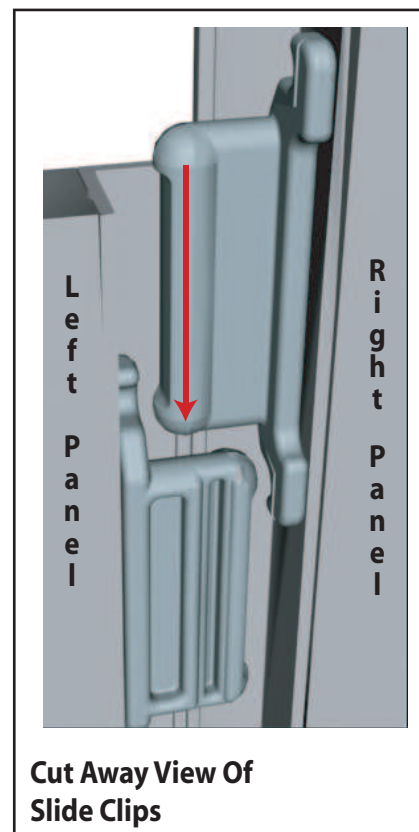

Components connect together by aligning them and sliding downward connecting clips together.

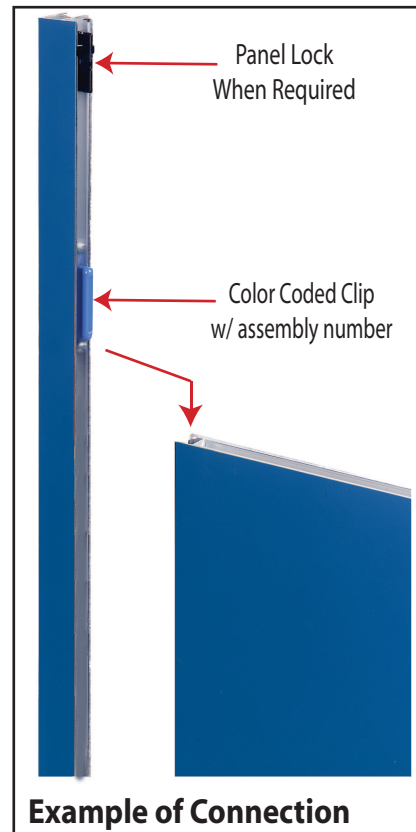

Configurations are assembled from left to right, usually starting with #1 and following the numbered sequence.

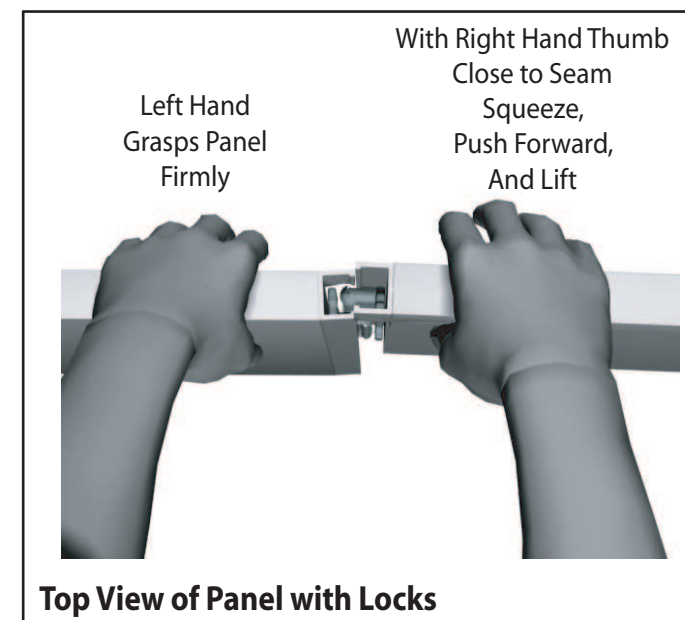

The first level of components contains panel locks that are located at the top of the panel for extra stability and a seamless connection. When disassembling panels, twist top connection slightly and lift right panel upward.

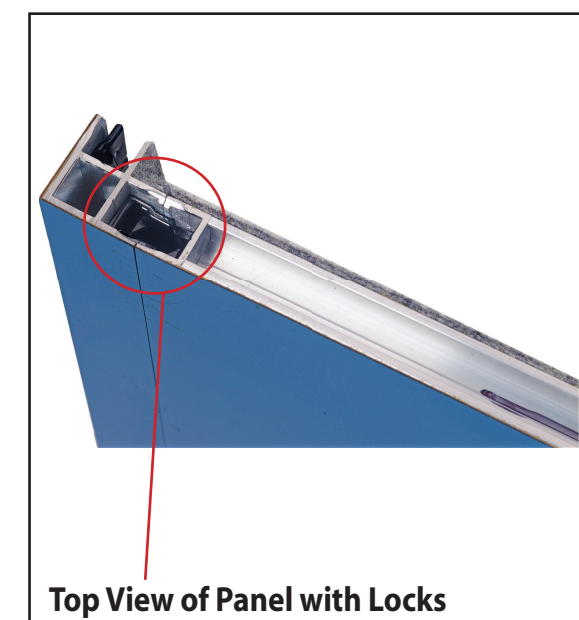

866.652.2100

Item Number	Description	Item Number	Description	Item Number	Description	Item Number	Description
1	46”h End Cap	17	19”w x 46”h Flat Panel	33	19”w x 38”h Flat Panel	47	19”w x 38”h Door Panel
2	11.5”w x 46”h Flat Panel	18	46”h 3-Way Connector	34	38”h 90° Connector	48	38”h 90° Connector
3	46”h 90° Connector	19	23”w x 38”h Flat Panel	35	23”w x 38”h Door Panel	49	19”w x 38”h Flat Panel
4	23”w x 46”h Flat Panel	20	23”w x 46”h Flat Panel	36	9.5”r x 38”h Curve Panel	50	38”h 90° Connector
5	46”h 3-Way Connector	21	46”h 120° Connector	37	9.5”r x 38”h Curve Panel	51	19”w x 38”h Flat Panel
6	23”w x 38”h Flat Panel	22	23”w x 46”h Flat Panel	38	23”w x 38”h Flat Panel	52	38”h 90° Connector
7	23”w x 46”h Flat Panel	23	23”w x 46”h Flat Panel	39	38”h 90° Connector	53	19”w x 38”h Flat Panel
8	46”h 120° Connector	24	46”h 120° Connector	40	19”w x 38”h Flat Panel	54	38”h 90° Connector
9	23”w x 46”h Flat Panel	25	23”w x 46”h Flat Panel	41	38”h 90° Connector		
10	23”w x 46”h Flat Panel	26	23”w x 38”h Door Panel	42	23”w x 38”h Flat Panel		
11	46”h 120° Connector	27	23”w x 38”h Flat Panel	43	9.5”r x 38”h Curve Panel		
12	23”w x 46”h Flat Panel	28	46”h 3-Way Connector	44	9.5”r x 38”h Curve Panel		
13	23”w x 38”h Door Panel	29	23”w x 46”h Flat Panel	45	23”w x 38”h Door Panel		
14	23”w x 38”h Flat Panel	30	46”h 90° Connector	46	38”h 90° Connector		
15	46”h 3-Way Connector	31	11.5”w x 46”h Flat Panel				
16	19”w x 46”h Flat Panel	32	46”h End Cap				

Steps:
Connect panels together in numerical order as shown in illustrations.

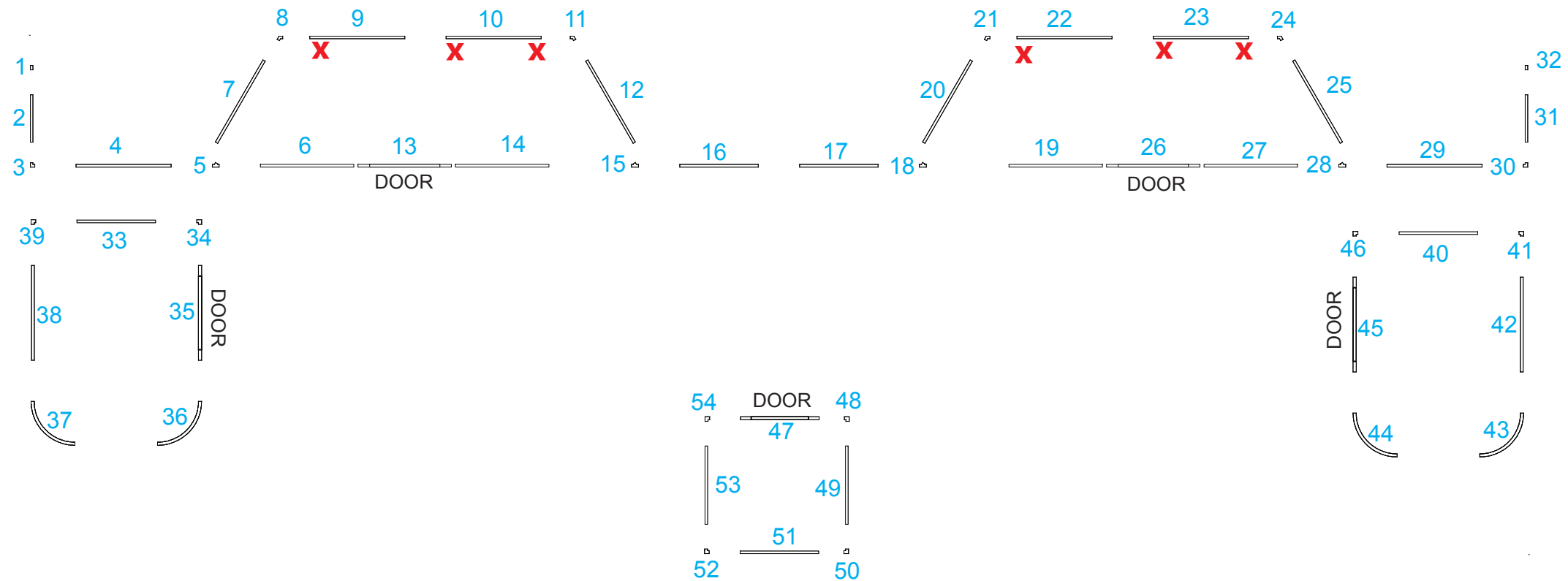

X = Thumbscrew Location

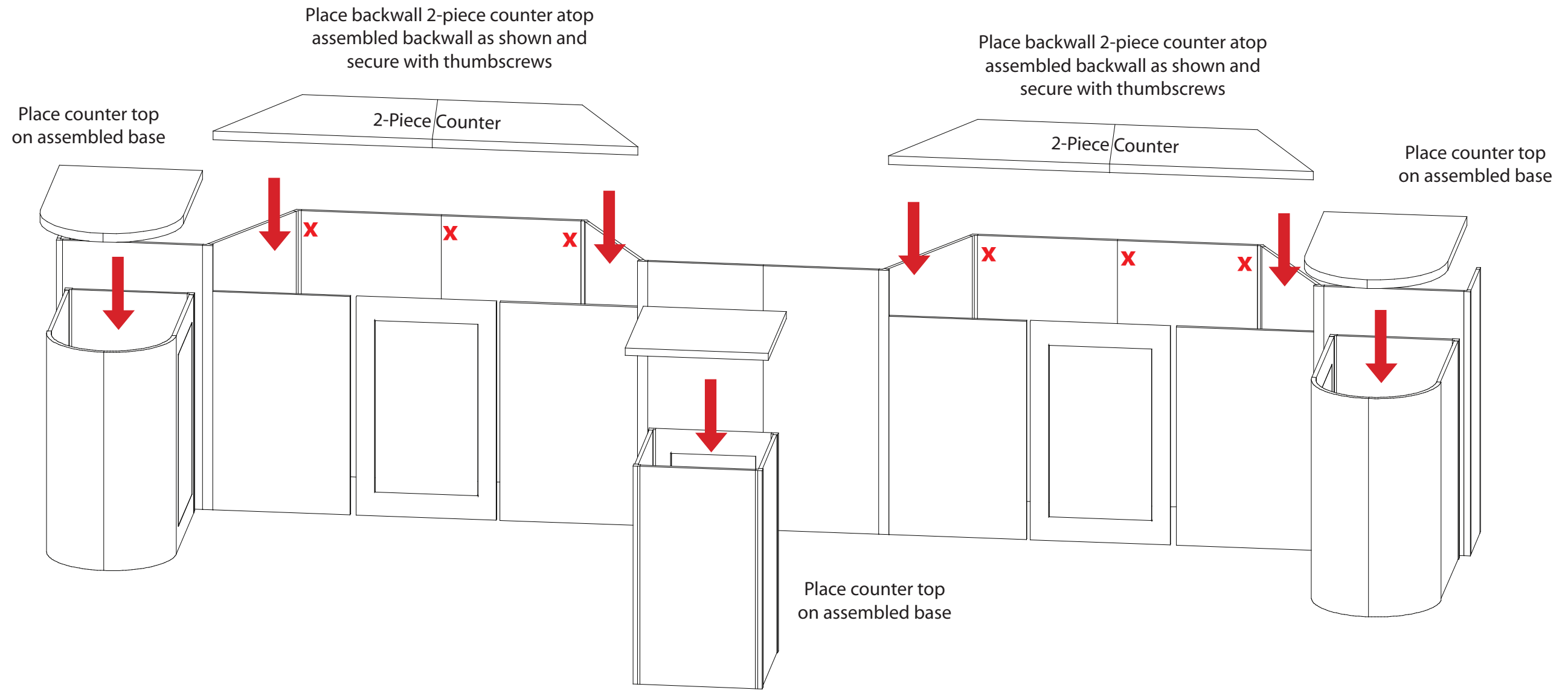

Item Number	Description	Item Number	Description
1	46" h End Cap	17	19" w x 46" h Flat Panel
2	11.5" w x 46" h Flat Panel	18	46" h 120° Connector
3	46" h 90° Connector	20	23" w x 46" h Flat Panel
4	23" w x 46" h Flat Panel	21	46" h 120° Connector
5	46" h 120° Connector	22	23" w x 46" h Slatwall Panel
7	23" w x 46" h Flat Panel	23	23" w x 46" h Slatwall Panel
8	46" h 120° Connector	24	46" h 120° Connector
9	23" w x 46" h Slatwall Panel	25	23" w x 46" h Flat Panel
10	23" w x 46" h Slatwall Panel	28	46" h 120° Connector
11	46" h 120° Connector	29	23" w x 46" h Flat Panel
12	23" w x 46" h Flat Panel	30	46" h 90° Connector
15	46" h 120° Connector	31	11.5" w x 46" h Flat Panel
16	19" w x 46" h Flat Panel	32	46" h End Cap

Steps:
Connect panels together in numerical order as shown in illustrations.

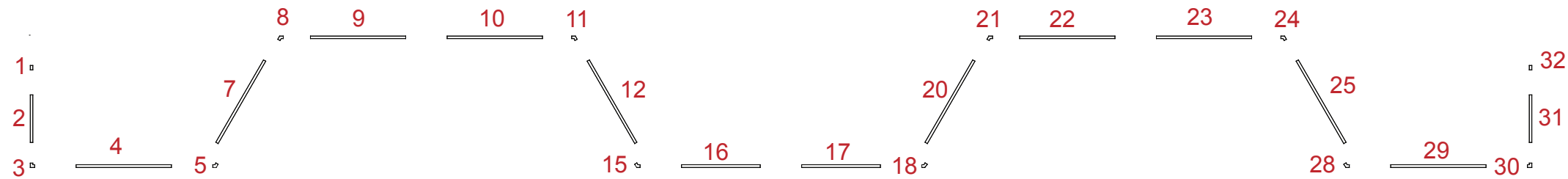

Header Kit Assembly

NOTE: Straight edges meet

Hook ceiling supports over top of display panels. NOTE: Make sure beveled aluminum channels on supports and straight edge of supports meet as shown.

Step 1

Hook light bars over the ceiling supports, screw in light bulbs and let the cords hang over the back of the display. Then hook header over panel tops.

Step 2

Install ceiling diffuser panels

Place ceiling atop lip on header and ceiling supports.

Step 3

23" w x 46" h panel

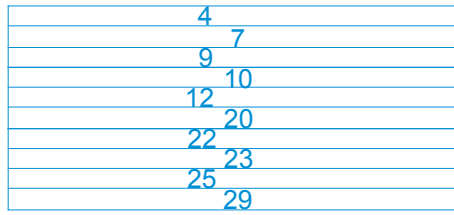

Case 1 of 8

Additional Item:

23" w x 46" h panel

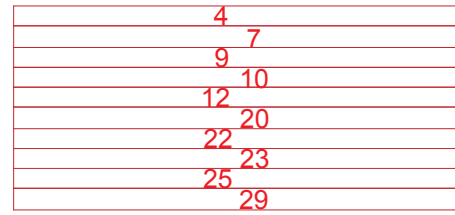

Case 2 of 8

Additional Item:

19" w x 46" h panel + Connector



23" w x 38" h panel + Connector

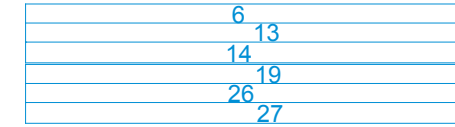

Case 3 of 8

Additional Item:

Peninsular Pedestal

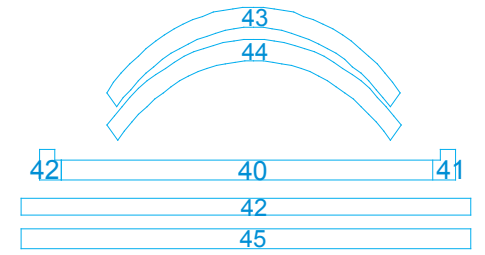

Peninsular Counter Top

Case 4 of 8

Additional Item:

Peninsular Pedestal

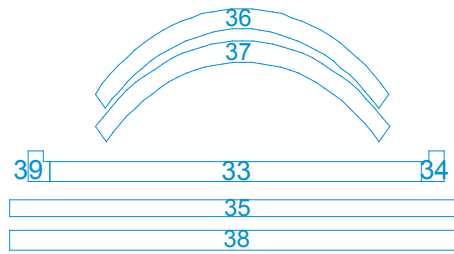

Peninsular Counter

Case 5 of 8

Additional Item:

11" w x 46" h panel + Connector

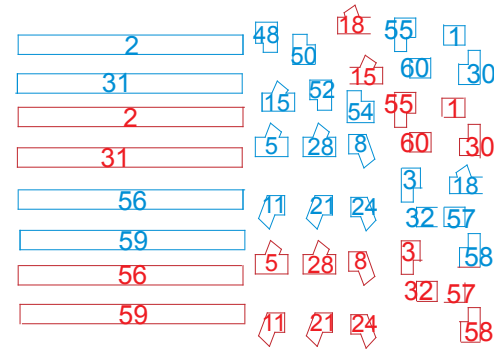

Case 6 of 8

Additional Item:

Square Pedestal

Square Counter Top

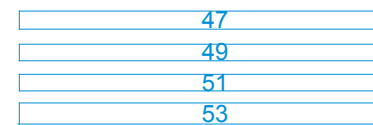

Case 7 of 8

Additional Item:

Ceiling Supports

Lights and Setup Hardware

Alcove Counter

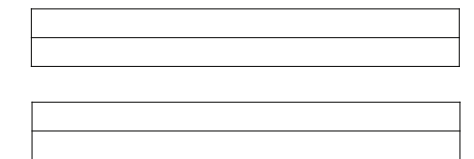

Case 8 of 8

Additional Item:

Ceilings
