

euro It

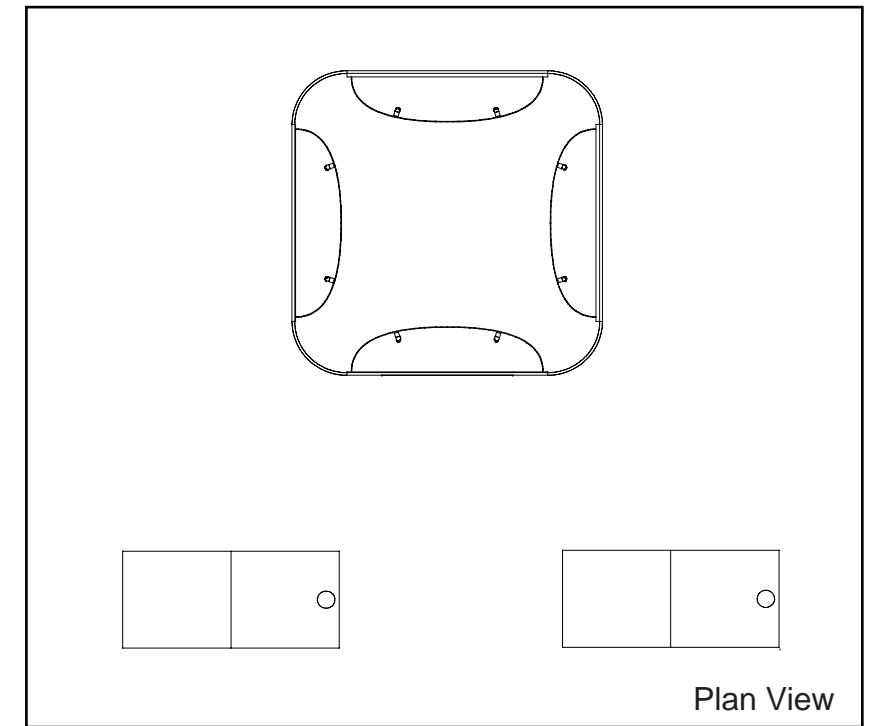
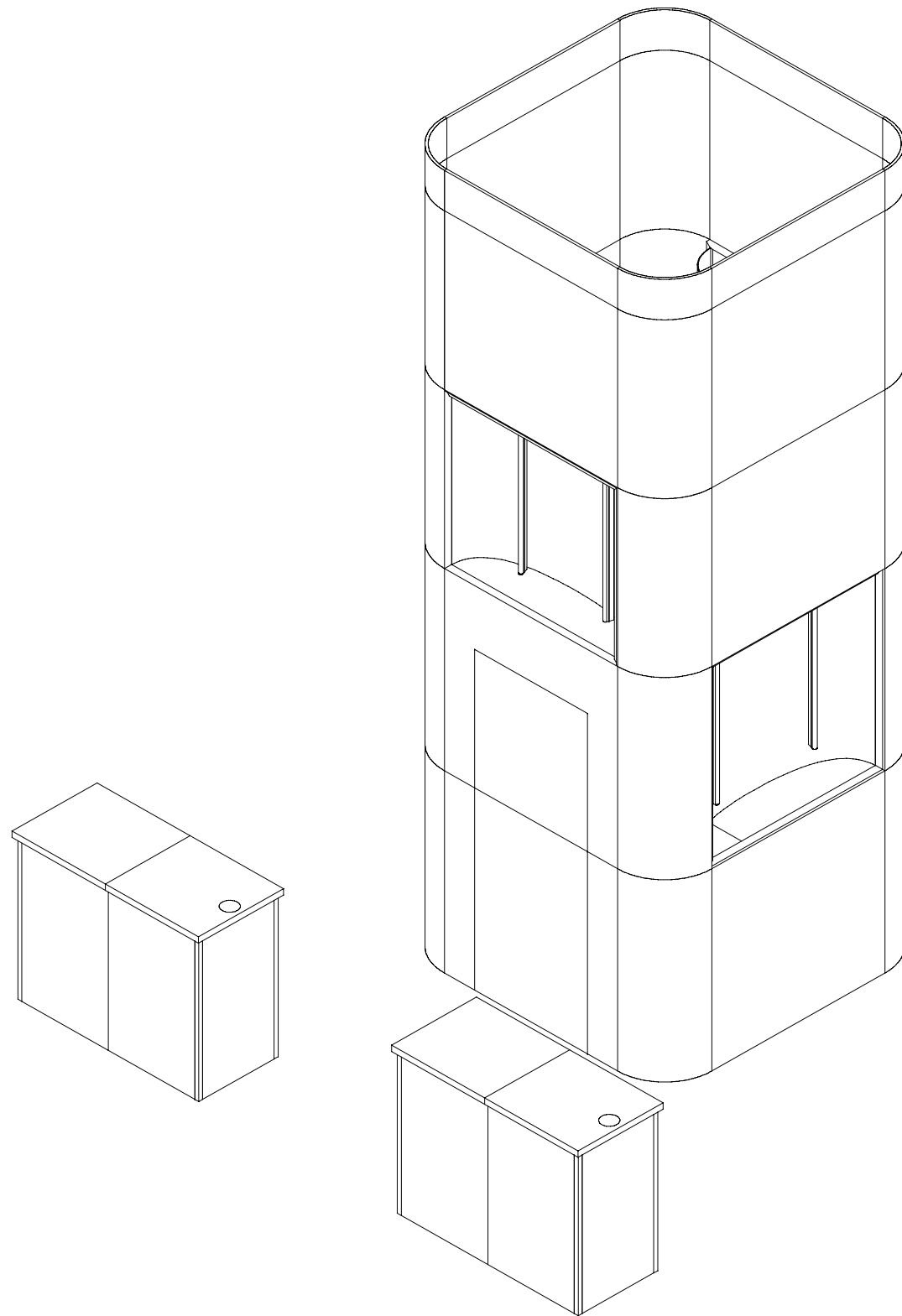

euro It | HYBRIDS

Euro LT Hybrids General Setup Instructions

Using Your Setup Instructions

The Euro LT Hybrids Setup Instructions are created specifically for your configuration. They are laid out sequentially in levels, including exploded views, and a logical series of detailed steps to assemble the main structure and components. We encourage you to study the instructions **before** attempting to assemble your exhibit.

Cleaning and Packing Your Display

- 1) When cleaning laminate countertops or panels use mild cleansers and a soft material such as cotton.
- 2) Keep all display components away from extreme heat and long exposure to sunlight to avoid warping and fading.
- 3) Retain all packing material. It will make re-packing much easier and will reduce the likelihood of shipping damage.

Level 1 = Blue
 Level 2 = Red
 Level 3 = Green
 Level 4 = Black

Color Code

The top clip is color coded to distinguish the level. The color coded clip also contains the numbered label

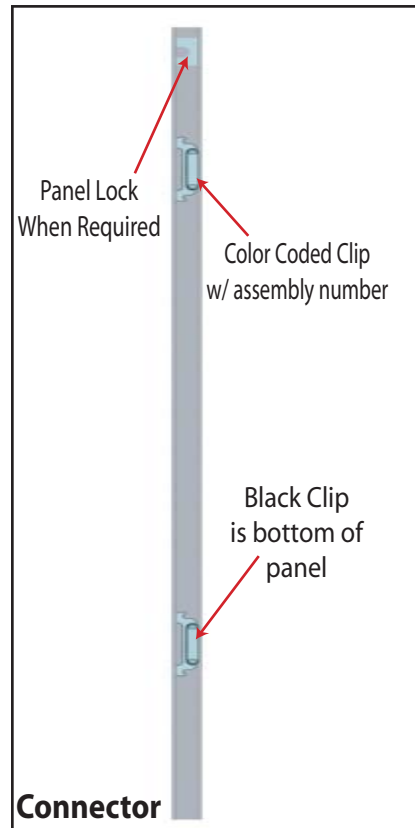

Each component has 2 clips, the lower clip is ALWAYS black..

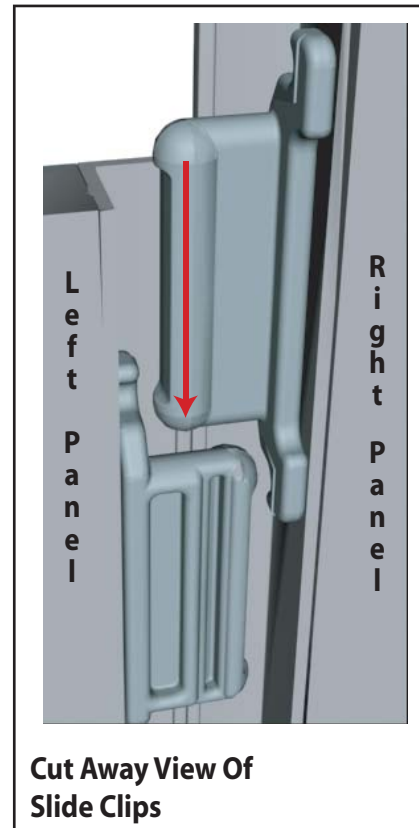

Components connect together by aligning them and sliding downward connecting clips together.

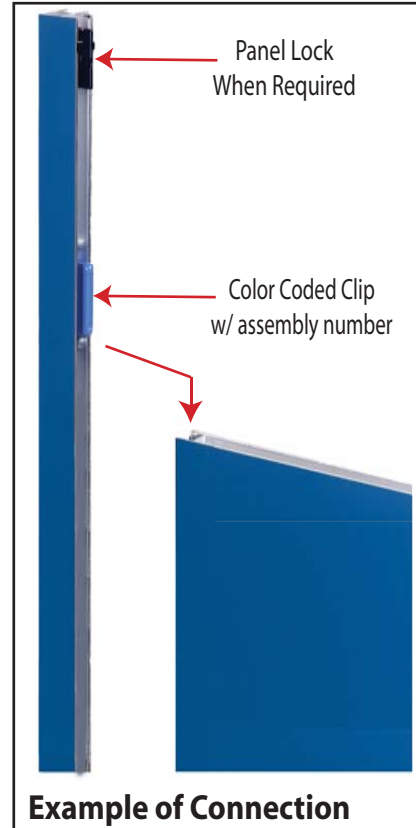

Configurations are assembled from left to right, usually starting with #1 and following the numbered sequence.

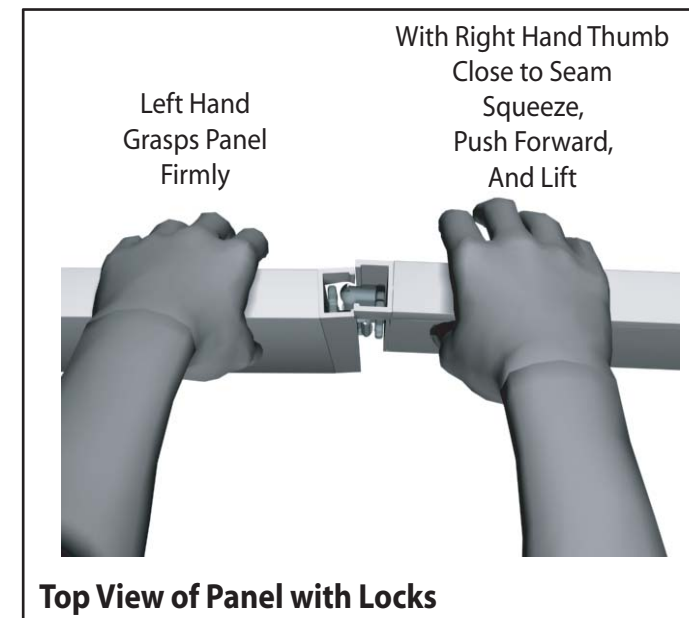

The first level of components contains panel locks that are located at the top of the panel for extra stability and a seamless connection. When disassembling panels, twist top connection slightly and lift right panel upward.

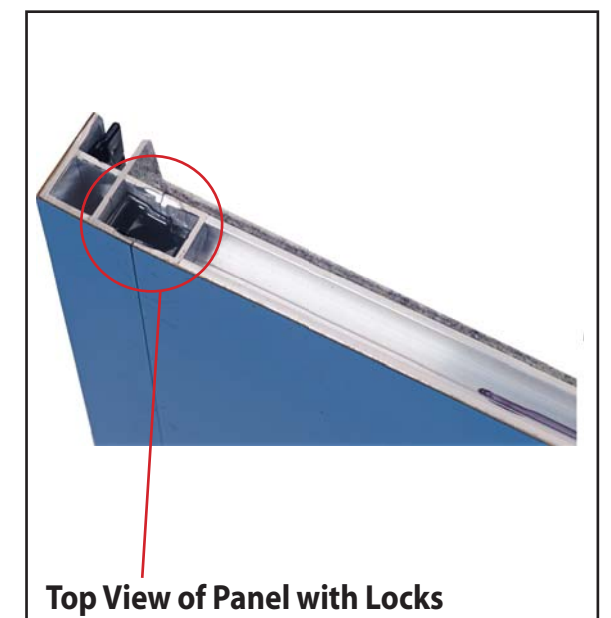

866.652.2100

Item Number	Description
1	11.5"r x 47.5"h Quarter Curve Panel
2	46"w x 47.5"h Flat Panel
3	11.5"r x 47.5"h Quarter Curve Panel
4	46"w x 47.5"h Flat Panel
5	11.5"r x 47.5"h Quarter Curve Panel
6	46"w x 47.5"h Flat Panel
7	11.5"r x 47.5"h Quarter Curve Panel
8/8a	47.5"h Lower Section Full-Size Door
9	23"w x 38"h Flat Panel w/ Door
10	23"w x 38"h Flat Panel w/ Door
11	47.5"h 90° Connector
12	19"w x 38"h Flat Panel
13	47.5"h 90° Connector
14	23"w x 38"h Flat Panel
15	23"w x 38"h Flat Panel
16	47.5"h 90° Connector
17	19"w x 38"h Flat Panel
18	47.5"h 90° Connector
19	23"w x 38"h Flat Panel w/ Door
20	23"w x 38"h Flat Panel w/ Door
21	47.5"h 90° Connector
22	19"w x 38"h Flat Panel
23	47.5"h 90° Connector
24	23"w x 38"h Flat Panel
25	23"w x 38"h Flat Panel
26	47.5"h 90° Connector
27	19"w x 38"h Flat Panel
28	47.5"h 90° Connector

Steps:
 1) Assemble by starting at panel #1* and continue in numerical order.

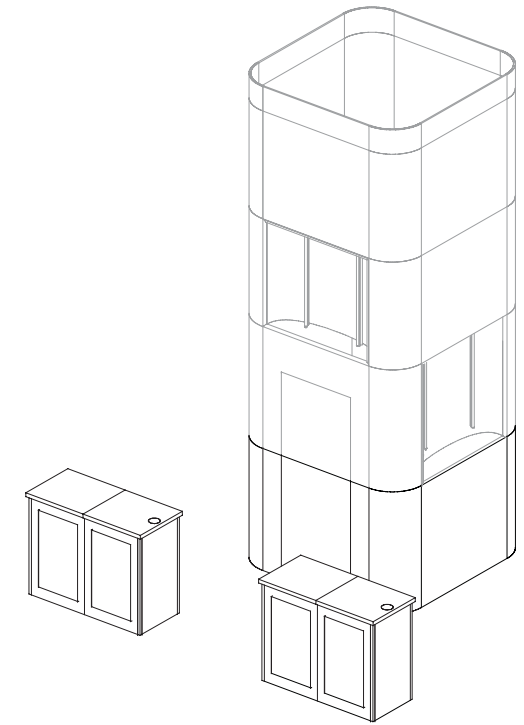
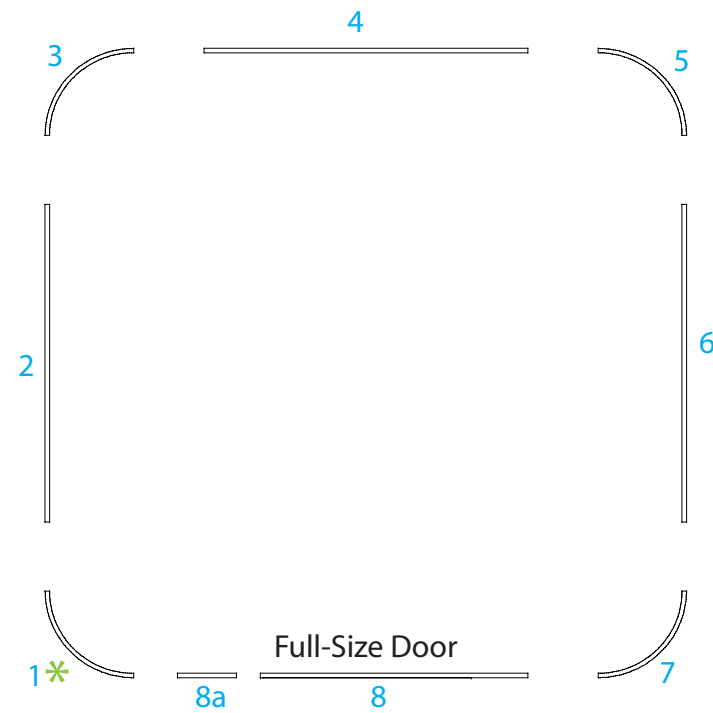

Set counter atop assembled base.

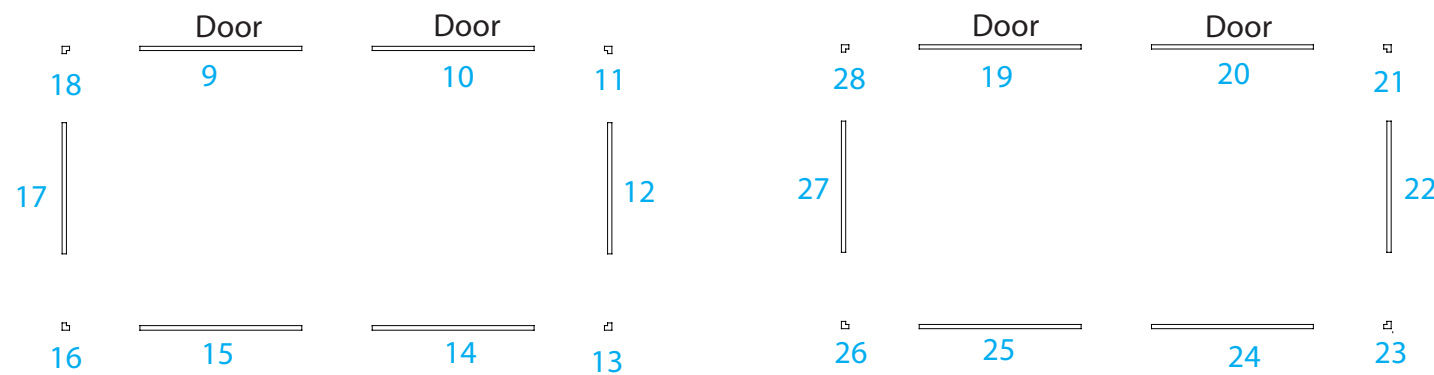
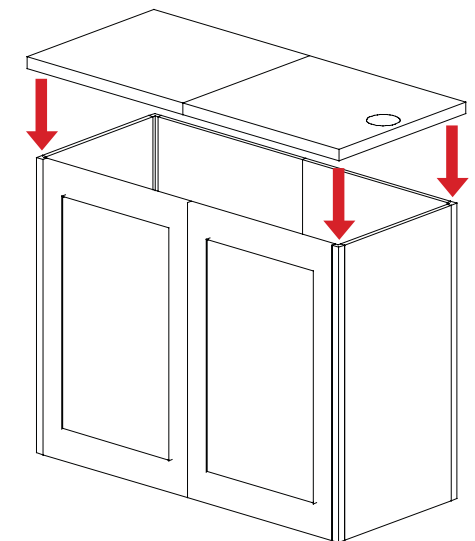

866.652.2100

Item Number	Description
1	11.5"r x 47.5"h Quarter Curve Panel
2	46"w x 47.5"h Light Box
3	11.5"r x 47.5"h Quarter Curve Panel
4	46"w x 47.5"h Flat Panel
5	11.5"r x 47.5"h Quarter Curve Panel
6	46"w x 47.5"h Light Box
7	11.5"r x 47.5"h Quarter Curve Panel
8	47.5"h Upper Section Full-Size Door

Steps:

1) Assemble by starting at panel #1* and continue in numerical order.

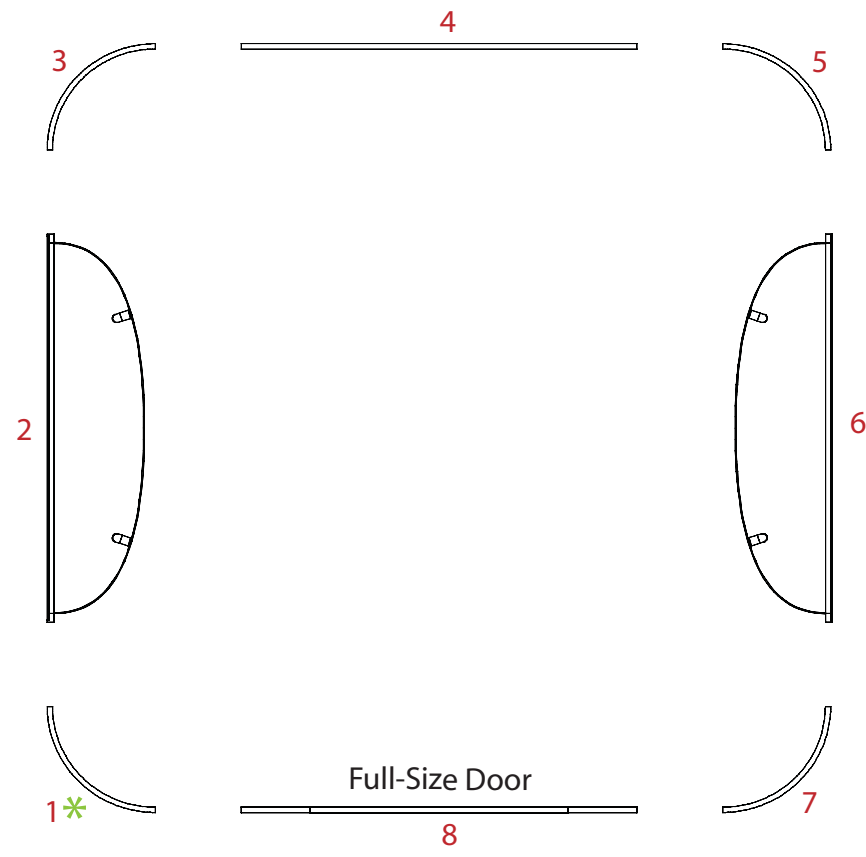
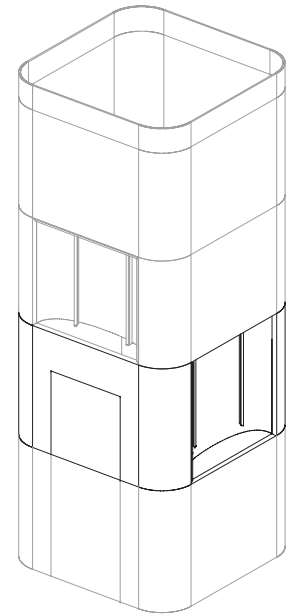

Light Box Assembly

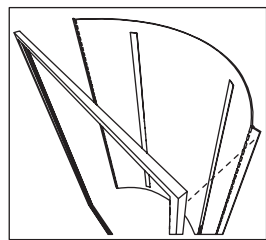

Step 1: Making sure that velcro is facing to the front of the booth bend reflector and attach hinged portion to velcro attached to back of light box frame.

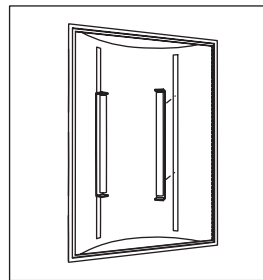

Step 2: Place light bars on velcro strips. Please note as every graphic is different some position adjustment may need to be made for optimum results.

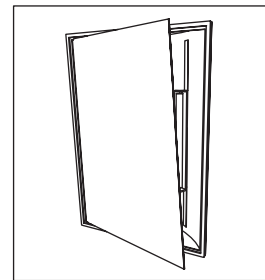

Step 3: Using magnetic tape place graphic onto inside flange of frame.

866.652.2100

Item Number	Description
1	11.5"r x 42"h Quarter Curve Panel
2	46"w x 42"h Flat Panel
3	11.5"r x 42"h Quarter Curve Panel
4	46"w x 42"h Light Box
5	11.5"r x 42"h Quarter Curve Panel
6	46"w x 42"h Flat Panel
7	11.5"r x 42"h Quarter Curve Panel
8	46"w x 42"h Light Box

Steps:

1) Assemble by starting at panel #1* and continue in numerical order.

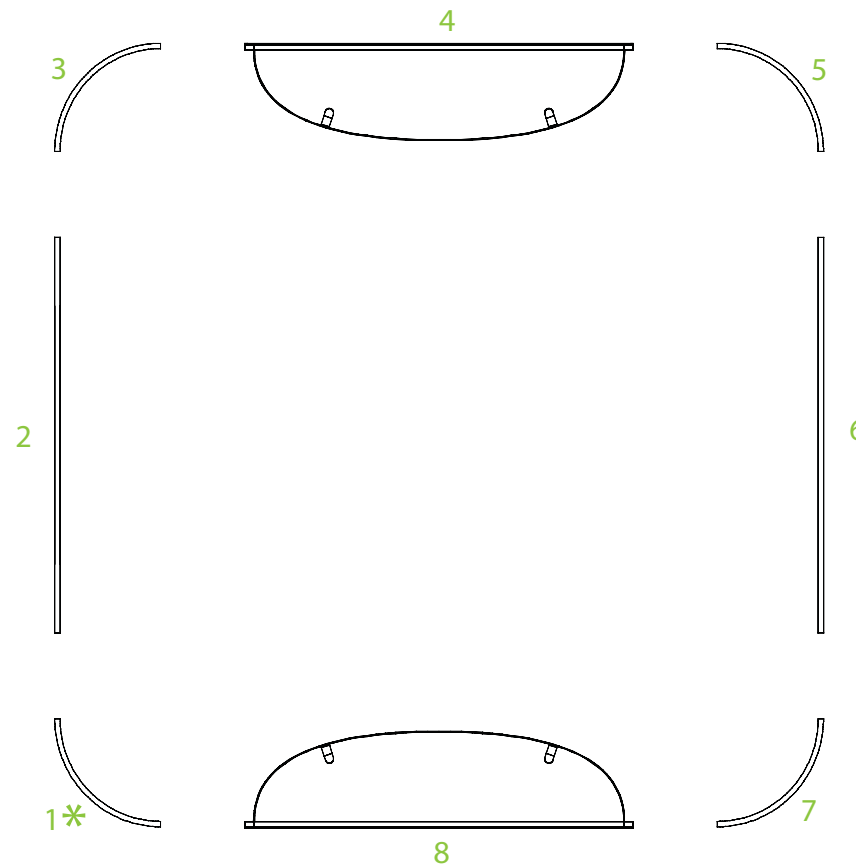
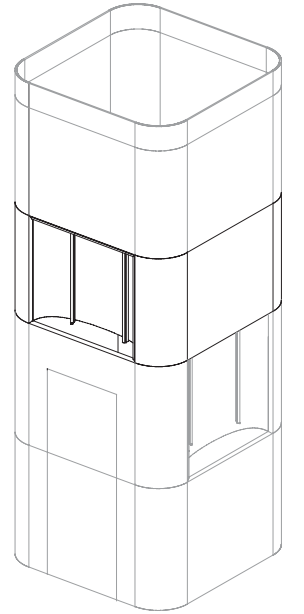

Light Box Assembly

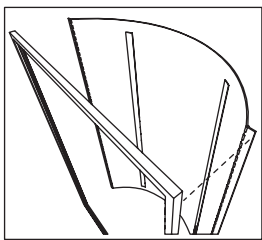

Step 1: Making sure that velcro is facing to the front of the booth bend reflector and attach hinged portion to velcro attached to back of light box frame.

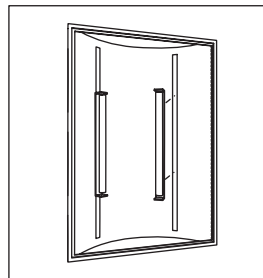

Step 2: Place light bars on velcro strips. Please note as every graphic is different some position adjustment may need to be made for optimum results.

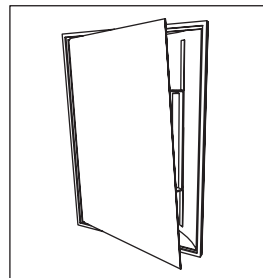

Step 3: Using magnetic tape place graphic onto inside flange of frame.

866.652.2100

Item Number	Description
1	11.5"r x 42"h Quarter Curve Panel
2	46"w x 42"h Flat Panel
3	11.5"r x 42"h Quarter Curve Panel
4	46"w x 42"h Flat Panel
5	11.5"r x 42"h Quarter Curve Panel
6	46"w x 42"h Flat Panel
7	11.5"r x 42"h Quarter Curve Panel
8	46"w x 42"h Flat Panel

Steps:

- 1) Assemble by starting at panel #1* and continue in numerical order.

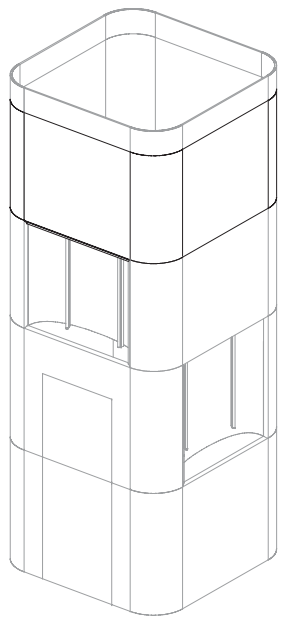
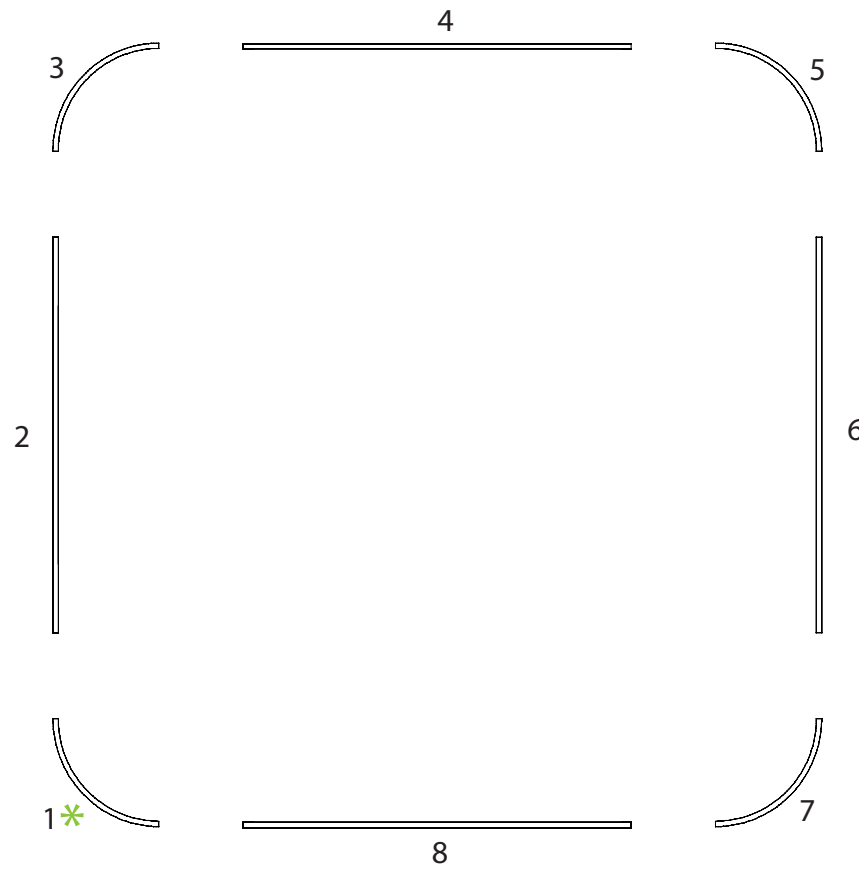

866.652.2100

Item Number	Description
1A	11.5"r x 15"h Quarter Curve Panel
2A	46"w x 15"h Light Box Panel
3A	11.5"r x 15"h Quarter Curve Panel
4A	46"w x 15"h Light Box Panel
5A	11.5"r x 15"h Quarter Curve Panel
6A	46"w x 15"h Light Box Panel
7A	11.5"r x 15"h Quarter Curve Panel
8A	46"w x 15"h Light Box Panel

Steps:

1) Assemble by starting at panel #1A* and continue in numerical order.

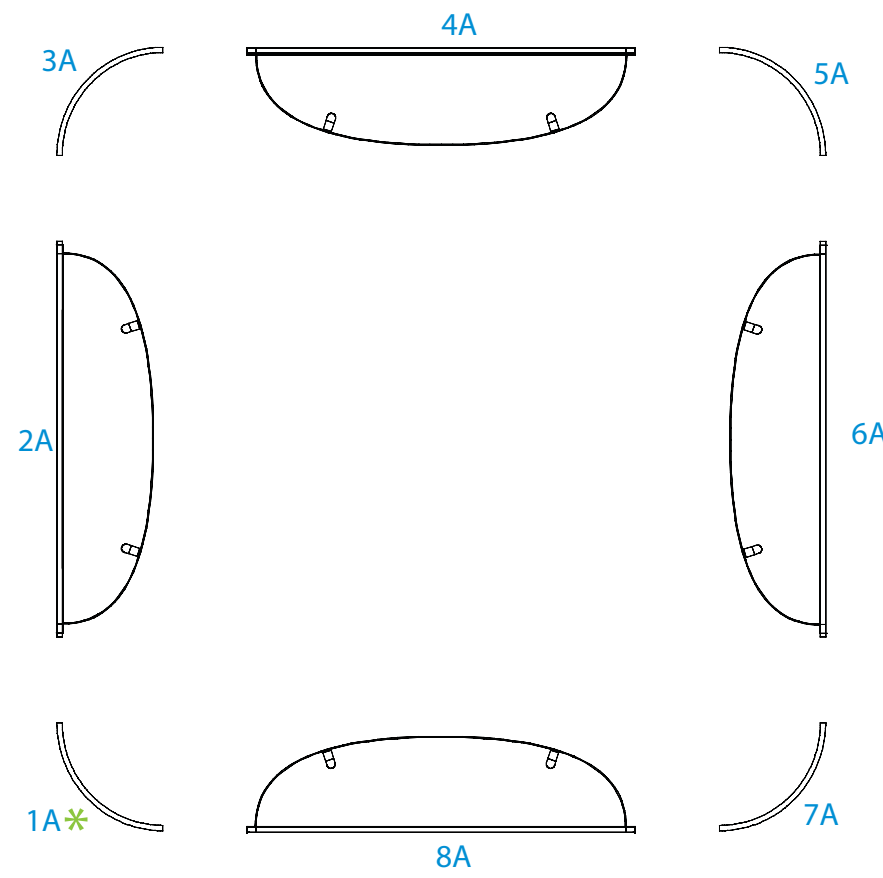
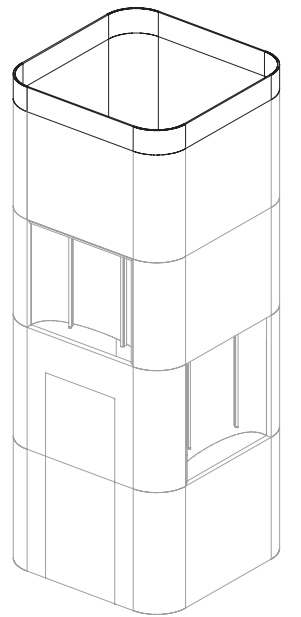

Light Box Assembly

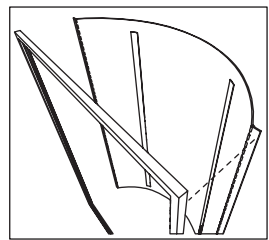

Step 1: Making sure that velcro is facing to the front of the booth bend reflector and attach hinged portion to velcro attached to back of light box frame.

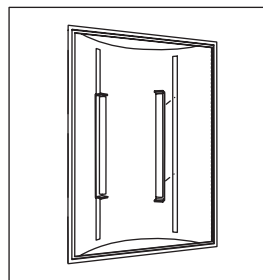

Step 2: Place light bars on velcro strips. Please note as every graphic is different some position adjustment may need to be made for optimum results.

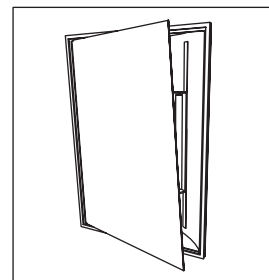

Step 3: Using magnetic tape place graphic onto inside flange of frame.

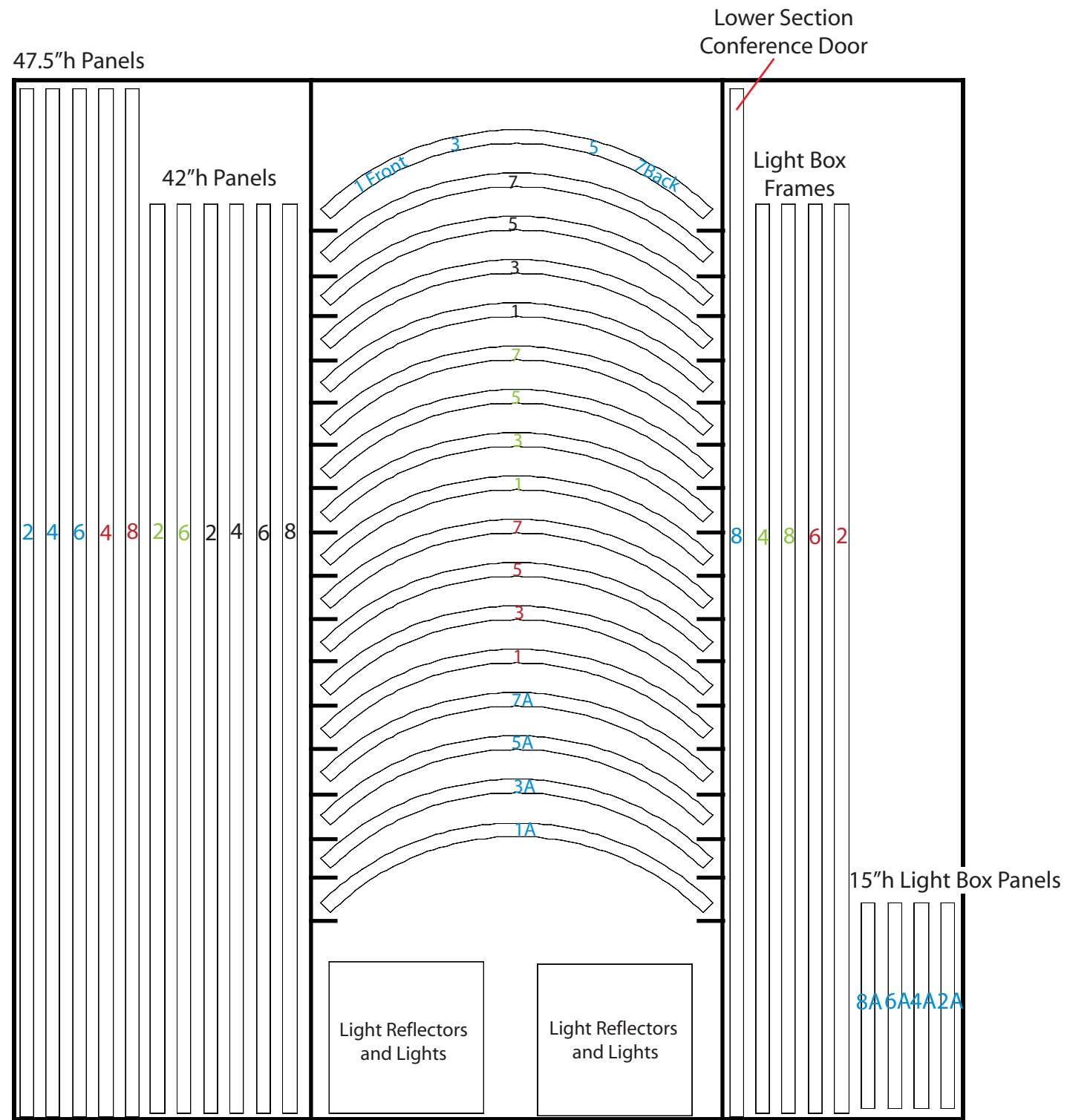

Jumbo Tub Front View

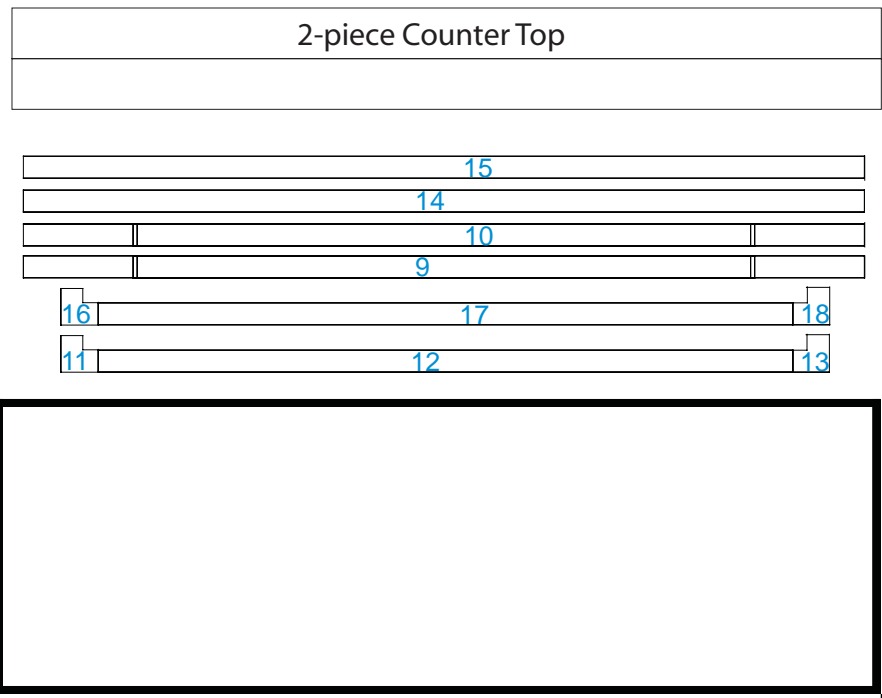

Case 1 of 2 - (1) LT Pedestal

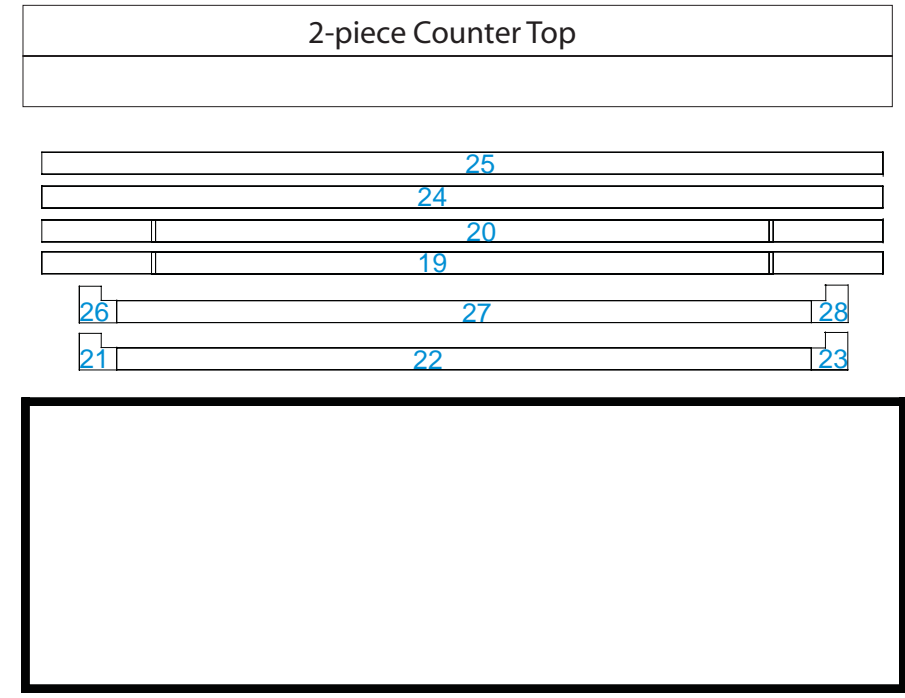

Case 2 of 2 - (1) LT Pedestal