

euro It | *HYBRIDS*

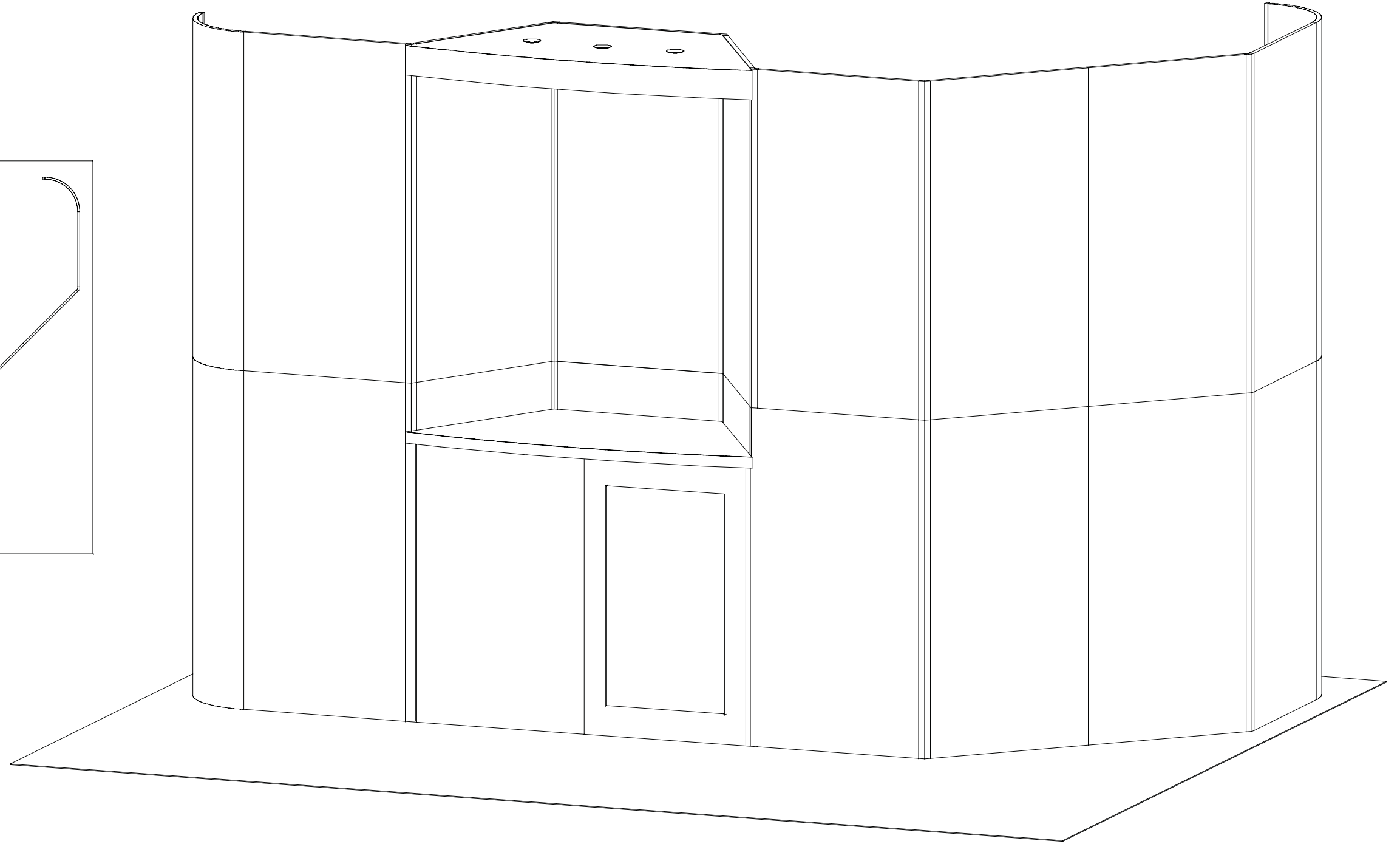
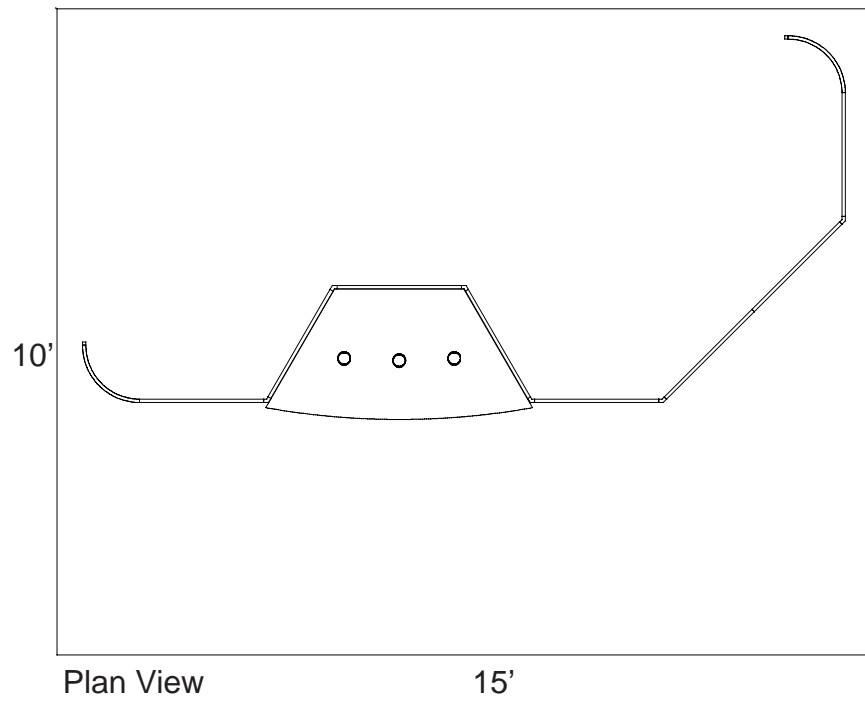

euro It | HYBRIDS

Euro LT Hybrids General Setup Instructions

Using Your Setup Instructions

The Euro LT Hybrids Setup Instructions are created specifically for your configuration. They are laid out sequentially in levels, including exploded views, and a logical series of detailed steps to assemble the main structure and components. We encourage you to study the instructions **before** attempting to assemble your exhibit.

Cleaning and Packing Your Display

- 1) When cleaning laminate countertops or panels use mild cleansers and a soft material such as cotton.
- 2) Keep all display components away from extreme heat and long exposure to sunlight to avoid warping and fading.
- 3) Retain all packing material. It will make re-packing much easier and will reduce the likelihood of shipping damage.

Level 1 = Blue
 Level 2 = Red
 Level 3 = Green
 Level 4 = Black

Color Code

The top clip is color coded to distinguish the level. The color coded clip also contains the numbered label

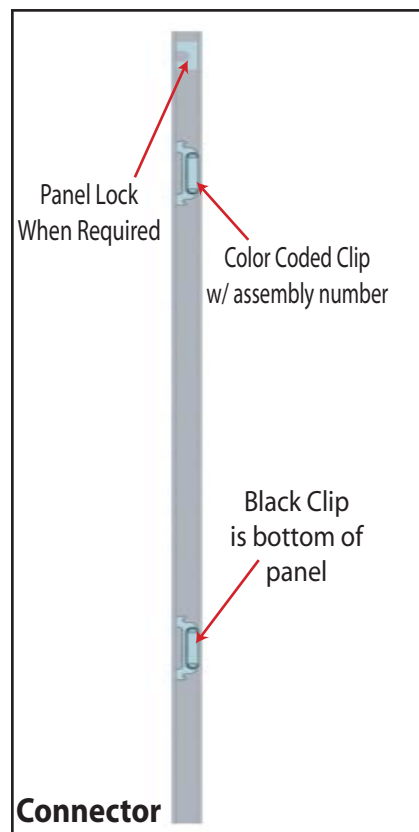

Each component has 2 clips, the lower clip is ALWAYS black..

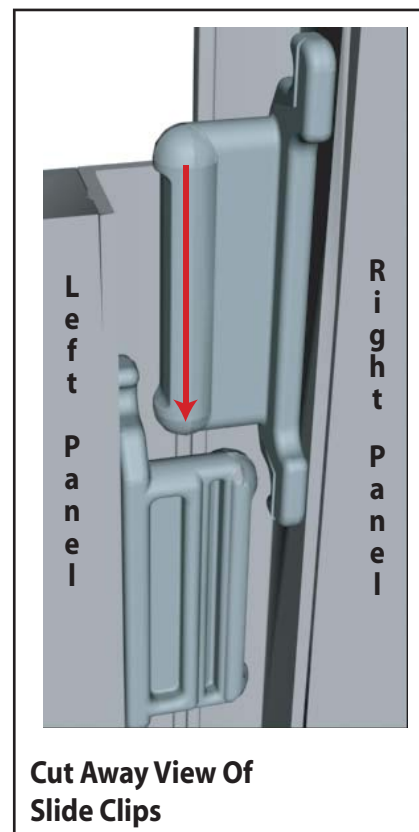

Components connect together by aligning them and sliding downward connecting clips together.

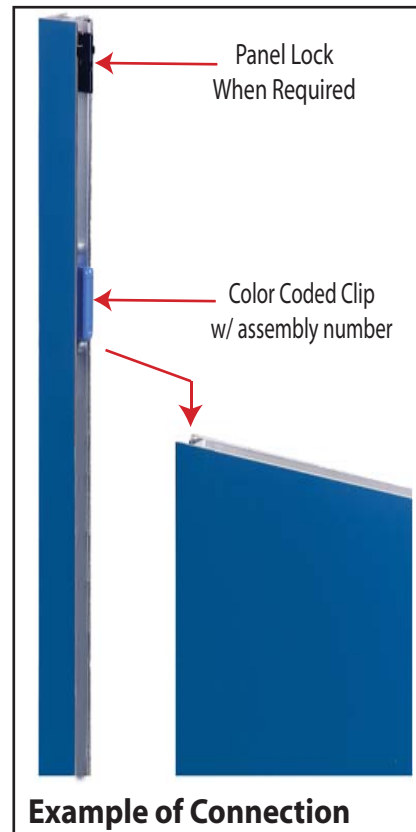

Configurations are assembled from left to right, usually starting with #1 and following the numbered sequence.

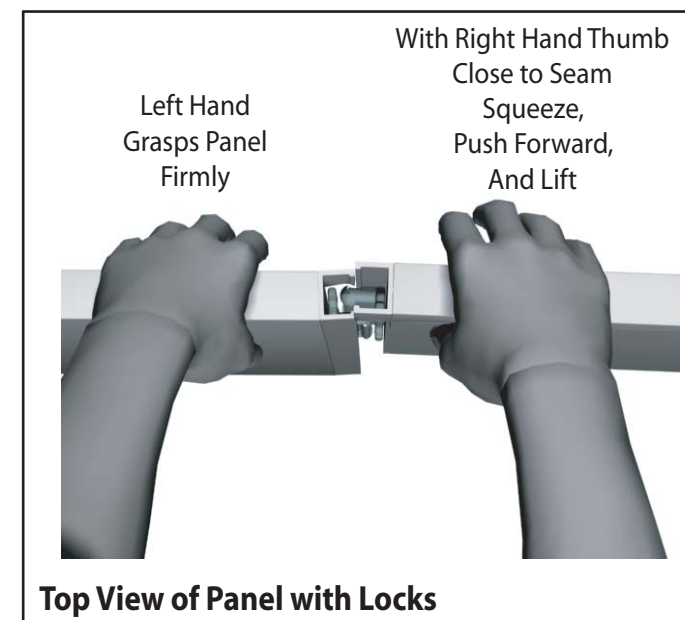

The first level of components contains panel locks that are located at the top of the panel for extra stability and a seamless connection. When disassembling panels, twist top connection slightly and lift right panel upward.

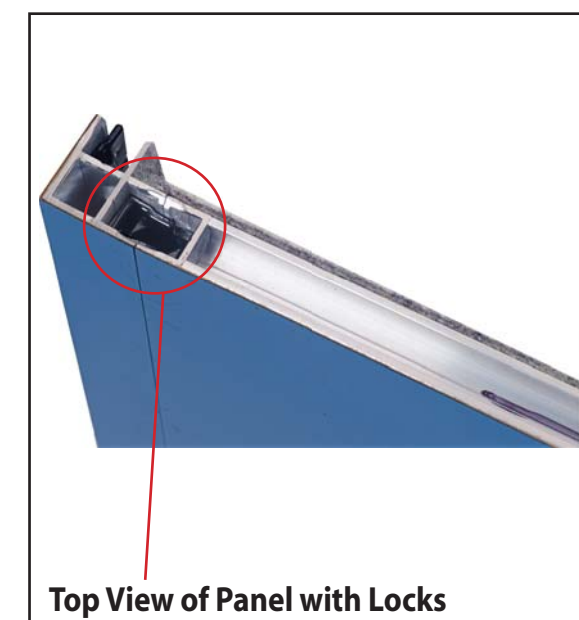

Item Number	Description	Item Number	Description
1	46" h End Cap	11	23" w x 38" h Flat Panel w/ Door
2	9.5" r x 46" h Curved Panel	12	46" h Custom Milled Y - Connector
3	23" w x 46" h Flat Panel	13	23" w x 46" h Flat Panel
4	46" h Custom Milled Y - Connector	14	46" h 120° Connector
5	23" w x 38" h Flat Panel	15	23" w x 46" h Flat Panel
6	23" w x 46" h Flat Panel	16	23" w x 46" h Flat Panel
7	46" h 120° Connector	17	46" h 120° Connector
8	23" w x 46" h Flat Panel	18	23" w x 46" h Flat Panel
9	46" h 120° Connector	19	9.5" r x 46" h Curved Panel
10	23" w x 46" h Flat Panel	20	46" h End Cap

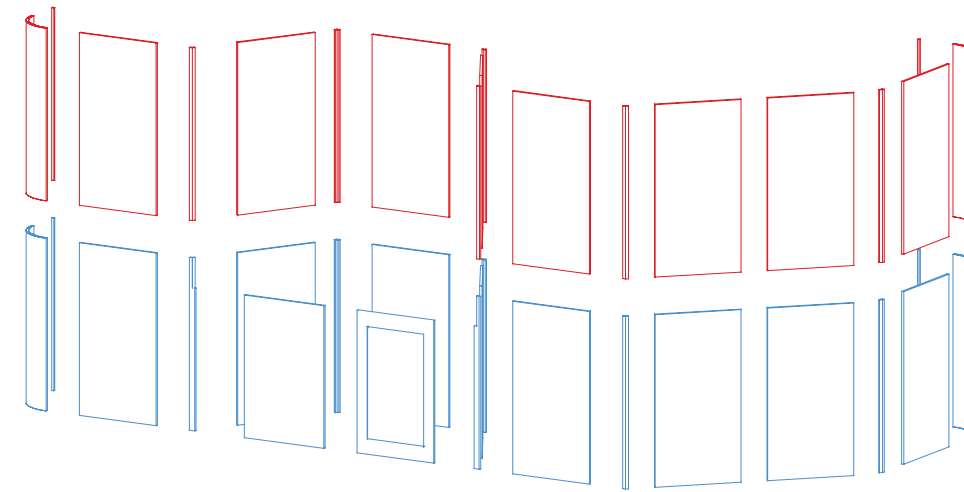

Steps:
 Connect panels together in numerical order starting with #1 as shown in illustrations.

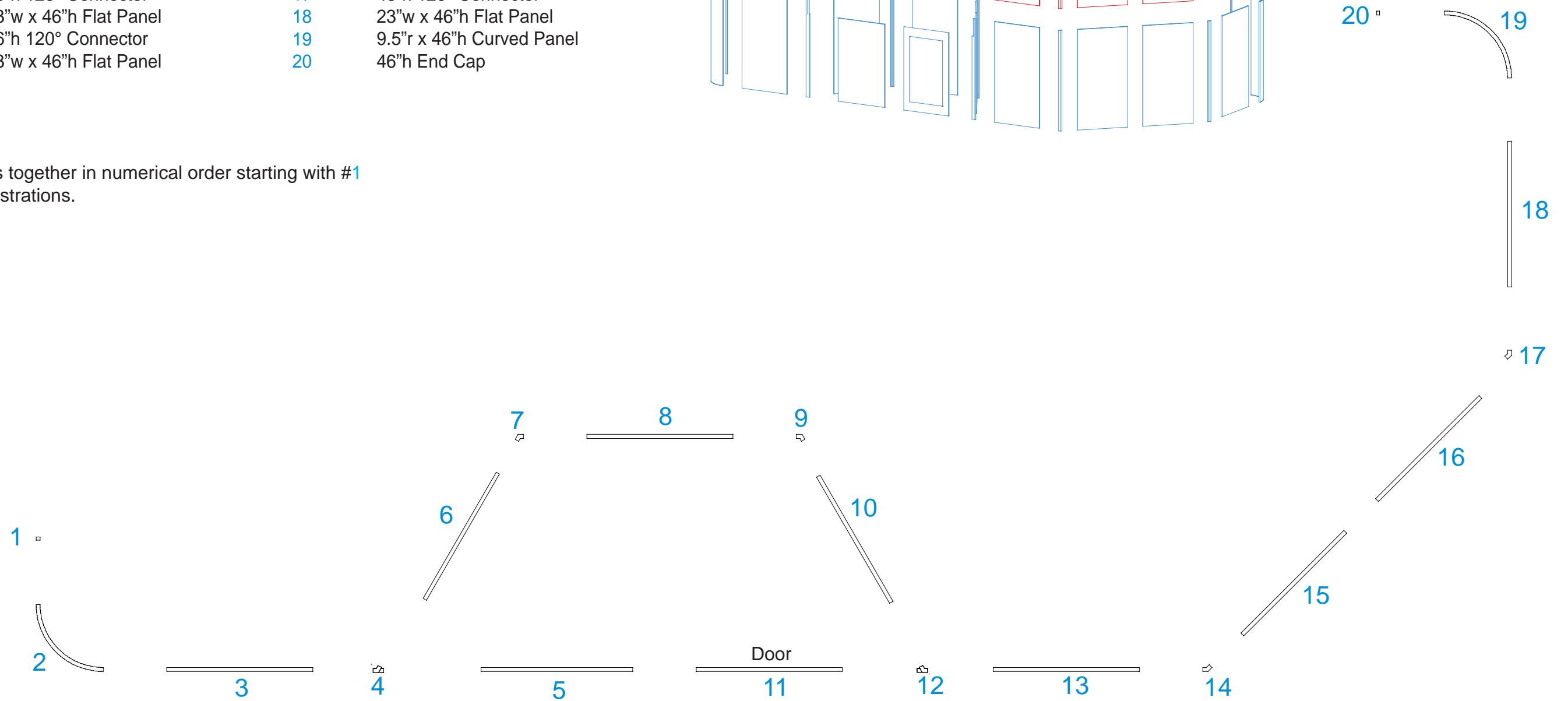

866.652.2100

Item Number	Description	Item Number	Description
1	46" h End Cap	12	46" h 120° Connector
2	9.5" r x 46" h Curved Panel	13	23" w x 46" h Flat Panel
3	23" w x 46" h Flat Panel	14	46" h 120° Connector
4	46" h 120° Connector	15	23" w x 46" h Flat Panel
6	23" w x 46" h Flat Panel	16	23" w x 46" h Flat Panel
7	46" h 120° Connector	17	46" h 120° Connector
8	23" w x 46" h Flat Panel	18	23" w x 46" h Flat Panel
9	46" h 120° Connector	19	9.5" r x 46" h Curved Panel
10	23" w x 46" h Flat Panel	20	46" h End Cap

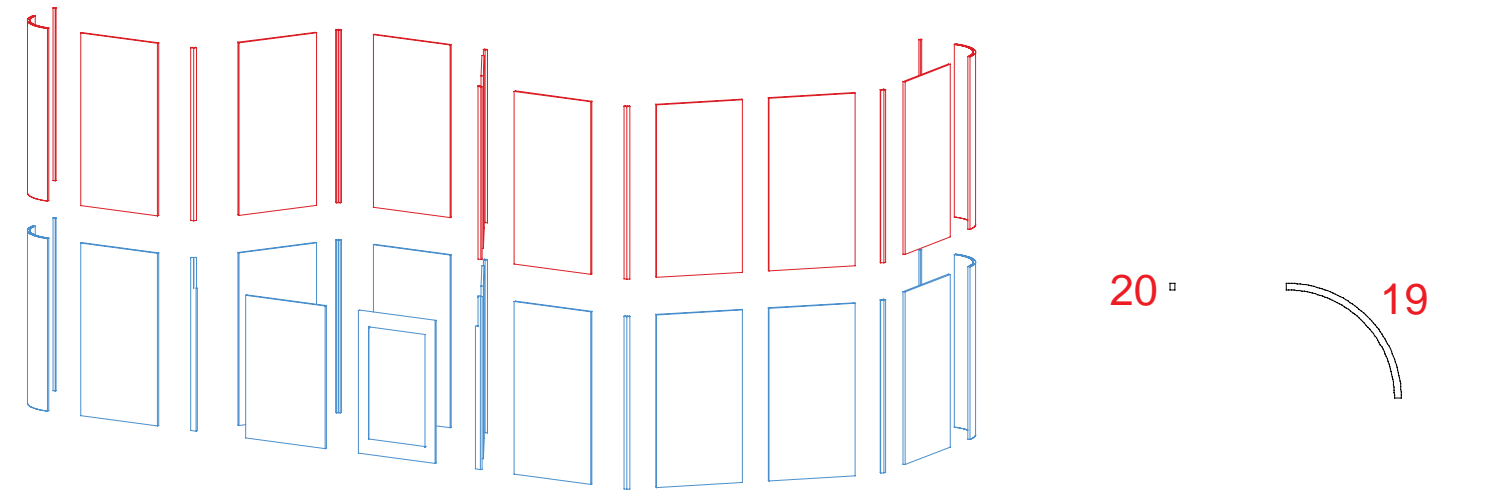

Steps:
 Connect panels together in numerical order starting with #1 as shown in illustrations.

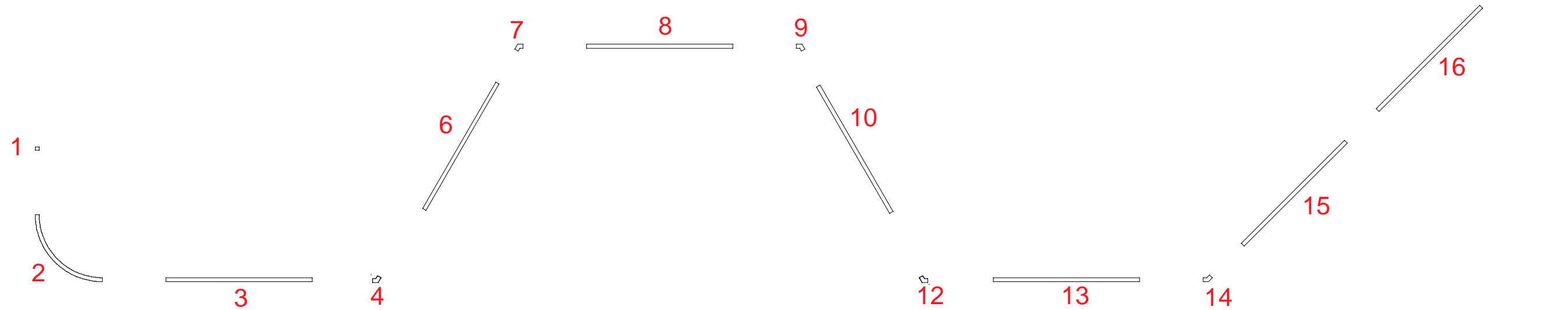

Ceiling Attachment

Attach ceiling atop panels using clips as shown in illustration.

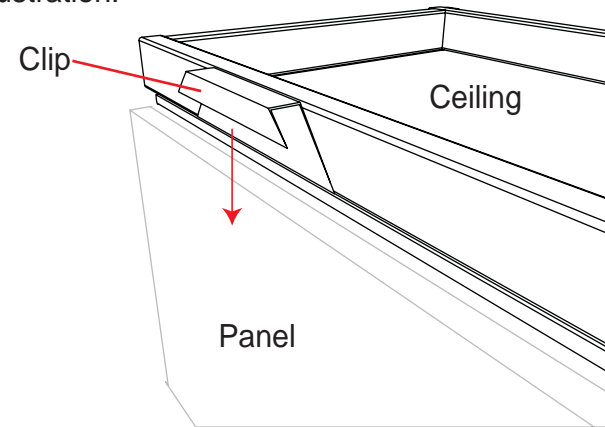

Counter Placment

Place Counter atop Alcove panels and attach to Backwall using Thumbscrews as shown.

