

Plan View

WHEN DISASSEMBLING ALUMINUM EXTRUSION, TIGHTEN ALL SETSCREWS AND LOCKS TO PREVENT LOSS DURING SHIPPING

# visionary™ IDESIGNS

## Using Your Setup Instructions

The Visionary Designs Setup Instructions are created specifically for your configuration. They are laid out sequentially, including an exploded view of the entire display, and then a logical series of detailed steps to assemble the main structure and components. We encourage you to study the instructions **before** attempting to assemble your exhibit.

Each page reminds you to tighten the setscrews after disassembling your exhibit to prevent loss of the locks and setscrews (see below in RED). This is **VERY IMPORTANT**.

## Cleaning and Packing Your Display

- 1) Use care when cleaning aluminum extrusion or acrylic inserts. Use only non-abrasive cleaners.
- 2) When cleaning laminate inserts or countertops, use mild cleansers and a soft material such as cotton.
- 3) Keep all display components away from extreme heat and long exposure to sunlight to avoid warping and fading.
- 4) Retain all packing material. It will make re-packing much easier and will reduce the likelihood of shipping damage.



**The Tool**

Most Visionary Designs exhibits can be assembled with the supplied Hex Key Tool. Occasionally, a flat head screwdriver may be required.



**Typical Connection**

Most horizontal extrusion connections have a patented expandable lock. This lock inserts into the groove of an opposing extrusion. Tightening the lock with the Hex Key Tool expands the lock and creates a strong positive connection.



**Typical Connection (cont'd)**

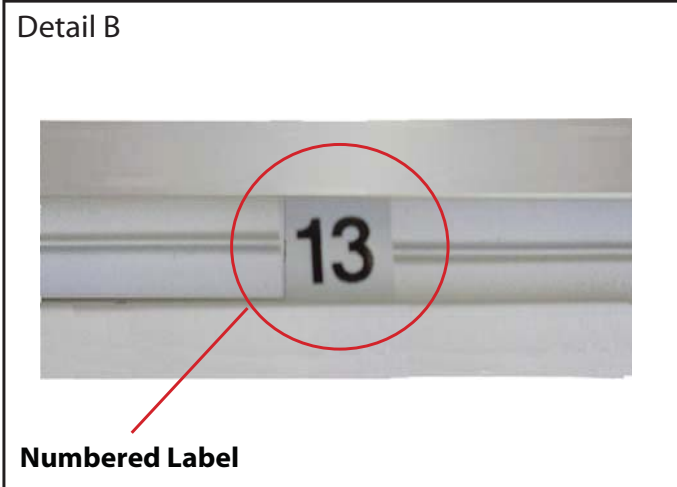

**Numbered Label**

Each extrusion contains a numbered label which corresponds with setup instructions. The label is located within a groove of the extrusion (when possible). With Visionary Designs the labels contain Black numbers unless otherwise specified.



**Horizontal Inline Connection** (remove only one setscrew)

Remove only (1) setscrew when disassembling. Replace setscrew in extrusion after assembling it. Before packing, replace setscrew in extrusion to avoid losing it.

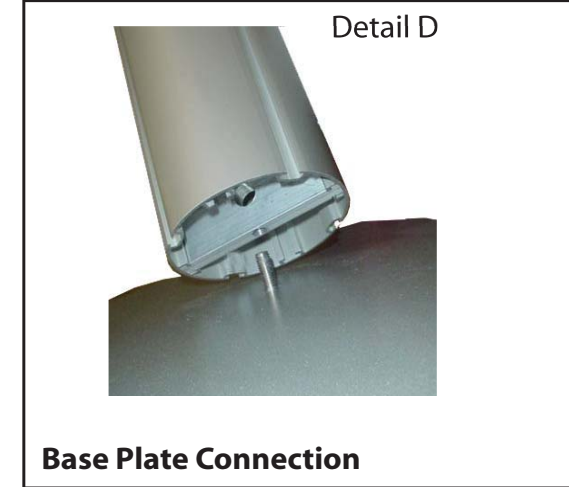

**Base Plate Connection**

Attach base plate to round or square vertical extrusion using the bolt provided. Be careful not to strip the threads.

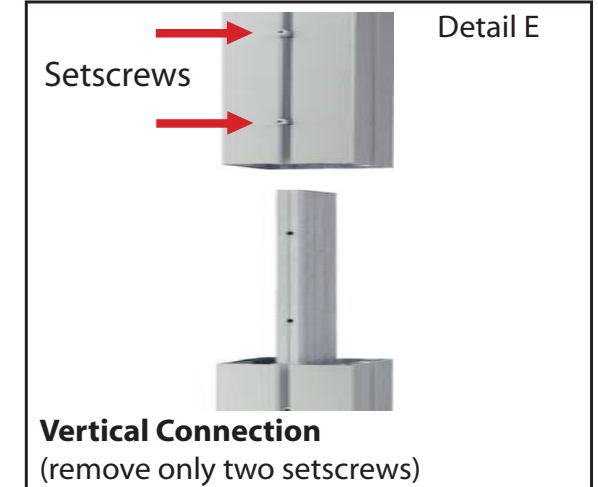

**Vertical Connection**  
(remove only two setscrews)

When vertical extrusions are packed in portable cases rather than crates or tubs, they must be broken down into smaller sections which then require assembly.

Remove only (2) setscrews when disassembling. Replace setscrews in extrusion after assembling it. Before packing, replace setscrews in extrusion to avoid losing them.

**WHEN DISASSEMBLING ALUMINUM EXTRUSION, TIGHTEN ALL SETSCREWS AND LOCKS TO PREVENT LOSS DURING SHIPPING**

866.652.2100

Part Number	Qty for Step	Description
1	2	Base Plates
2	2	42" h Lower Vertical extrusion
3	2	42" h Upper Vertical extrusion
4a/4b	2	42" Lower Horizontal w/ Velcro attached to Top of member
5a/5b	2	42" Middle Horizontal w/ Velcro attached to Bottom of member
6	2	40" Tapered Counter Support
7	2	19" Tapered Horizontal extrusion - Workstation Counter support

**Steps**

- 1) Attach 42" h Vertical extrusions [2] and 40" Tapered counter support [6] to Oval base plates [1].
- 2) Attach 42" h Upper Vertical extrusions [3] atop of Lower Vertical extrusion [2].
- 3) Assemble all Horizontal extrusions [4a to 4b and 5a to 5b].
- 4) Attach 19" Tapered Horizontal extrusion - Workstation Counter support [7] to 84" h Vertical [2/3].
- 5) Attach 84" Lower Horizontal assemblies [4a/4b] between Vertical assemblies [2/3] as shown.  
note: Velcro on Lower Horizontals must face UP.
- 6) Attach 84" Upper Horizontal assemblies [5a/5b] between Vertical assemblies [2/3] as shown.  
note: Velcro on Upper Horizontals must face DOWN.
- 7) Place Counter tops with Thumbscrews onto horizontal extrusion [7].

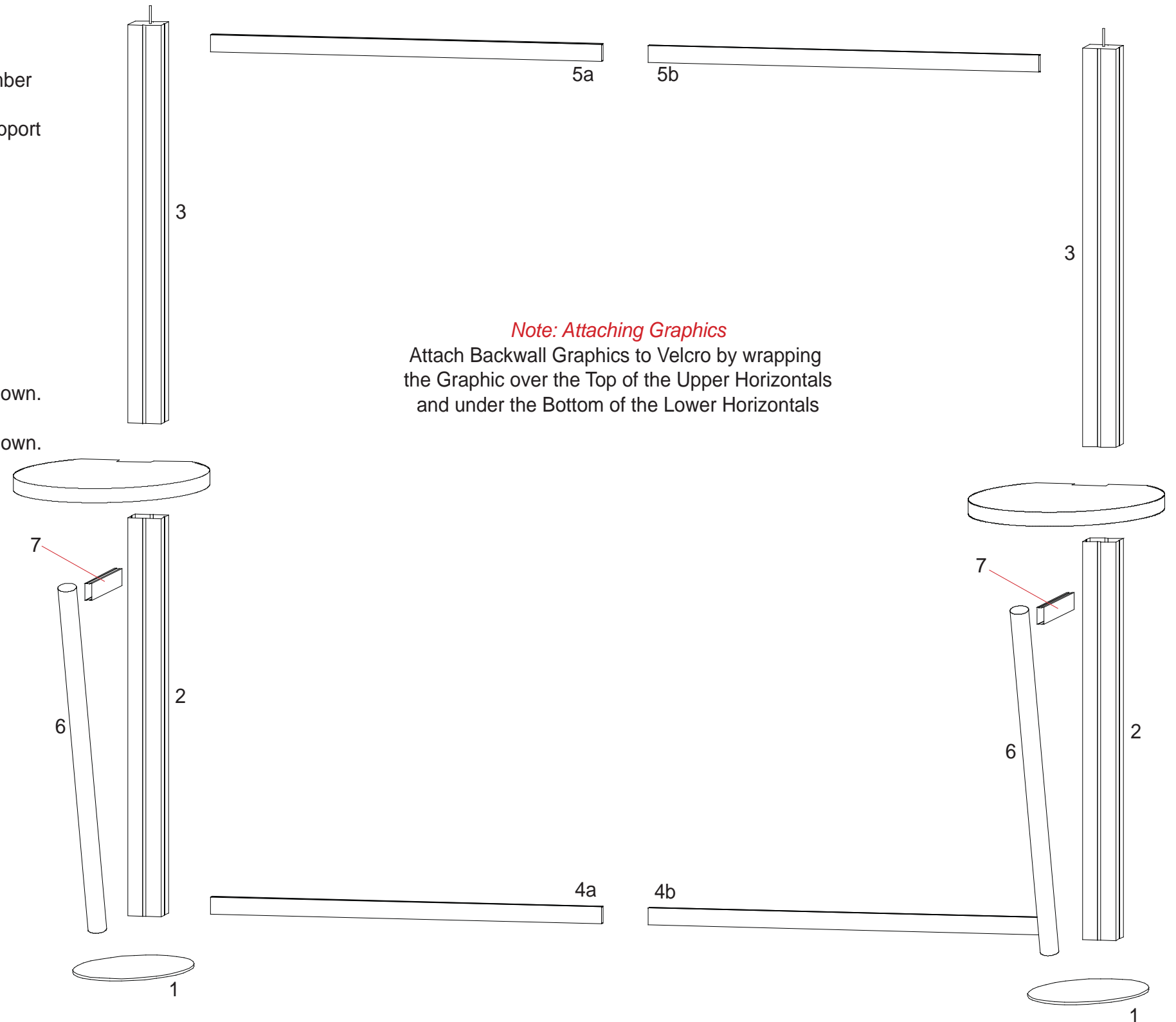

*Note: Attaching Graphics*  
 Attach Backwall Graphics to Velcro by wrapping the Graphic over the Top of the Upper Horizontals and under the Bottom of the Lower Horizontals

**WHEN DISASSEMBLING ALUMINUM EXTRUSION, TIGHTEN ALL SETSCREWS AND LOCKS TO PREVENT LOSS DURING SHIPPING**

866.652.2100

**Wing Attachment**

Slide A10 Clamp into groove of square extrusion.

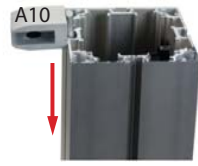

When desired location is found, tighten set screw to secure.



Set-Screw

Tighten black plastic set screw to secure Wing in place.



Black Plastic Set-screw

**Light Connection**

Attach Lights to Backwall where desired and tighten in place.

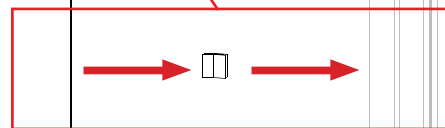
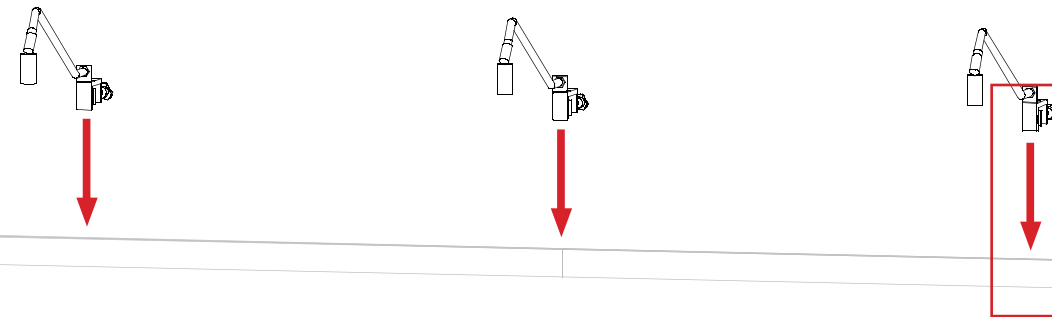
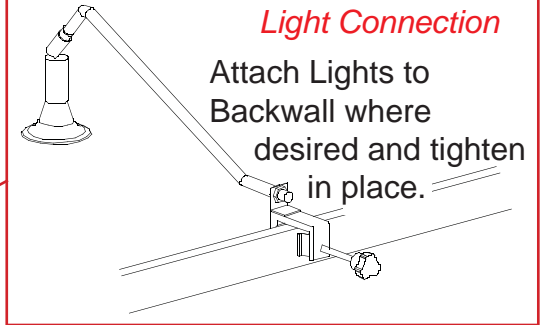

**WHEN DISASSEMBLING ALUMINUM EXTRUSION, TIGHTEN ALL SETSCREWS AND LOCKS TO PREVENT LOSS DURING SHIPPING**



**Steps:**

- 1) Connect canopy pieces together as shown.
- 2) Apply pillow case graphic to assembled canopy

**Using Your Setup Instructions**

The Aero Overhead Sign Setup Instructions are created specifically for your configuration. They include an exploded view of the frame which is sequentially numbered. We encourage you to study the instructions before attempting to assemble your exhibit.

Connections are kept very simple: no tools. Everything assembles with push-button connectors and pre-connected horizontal sections.

**Cleaning and Packing Your Display**

- 1) Use care when cleaning aluminum extrusion or acrylic inserts. Use only non-abrasive cleaners.
- 2) Retain all packing material. It will make re-packing much easier and will reduce the likelihood of shipping damage.

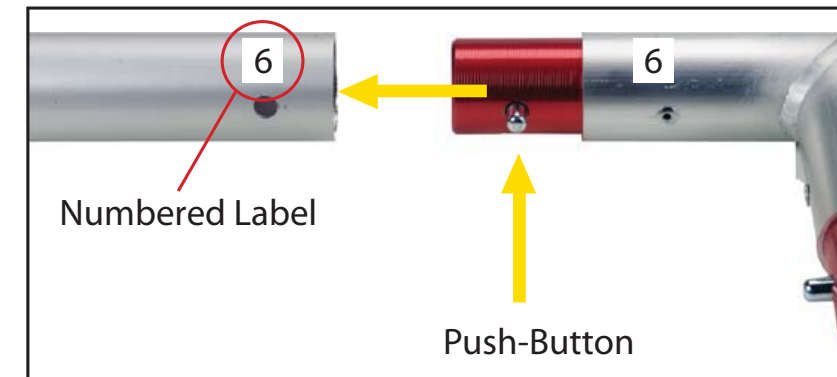

Connections are made by holding the button down and sliding the red tube into opposing tube until the connection is made. To disassemble push button and pull or twist extrusions apart.

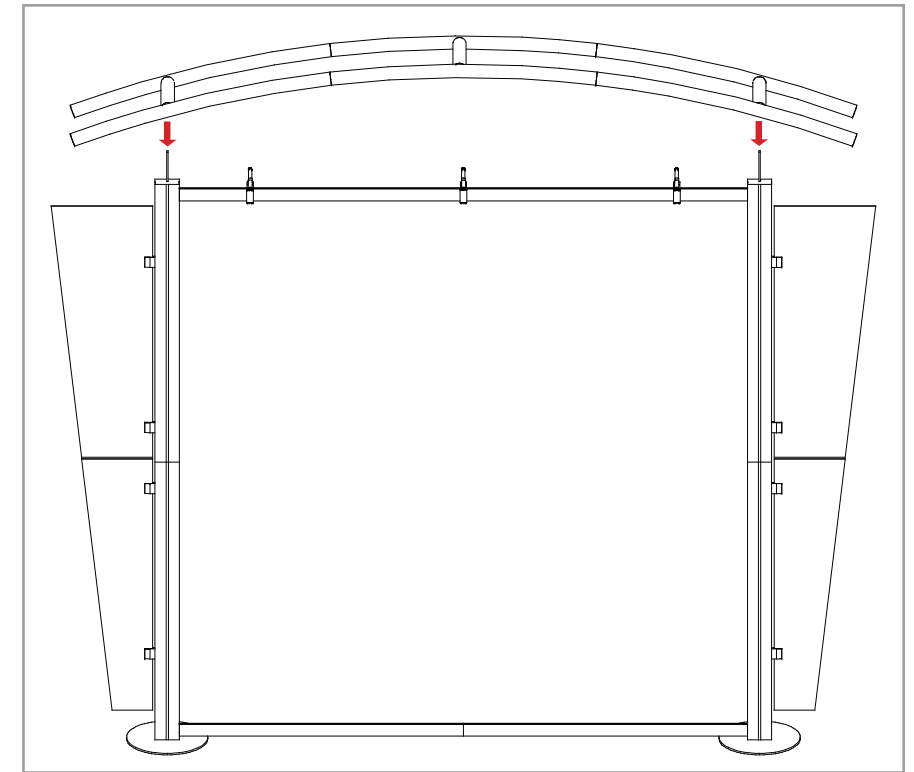
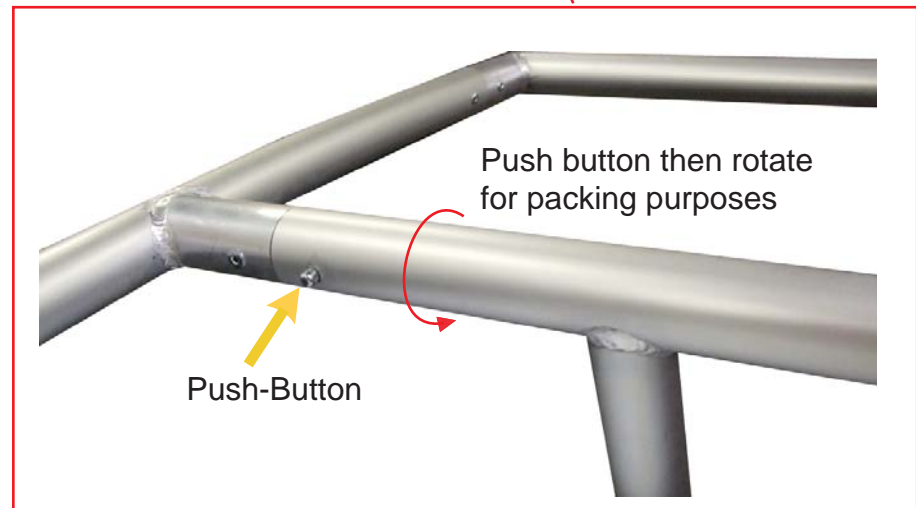
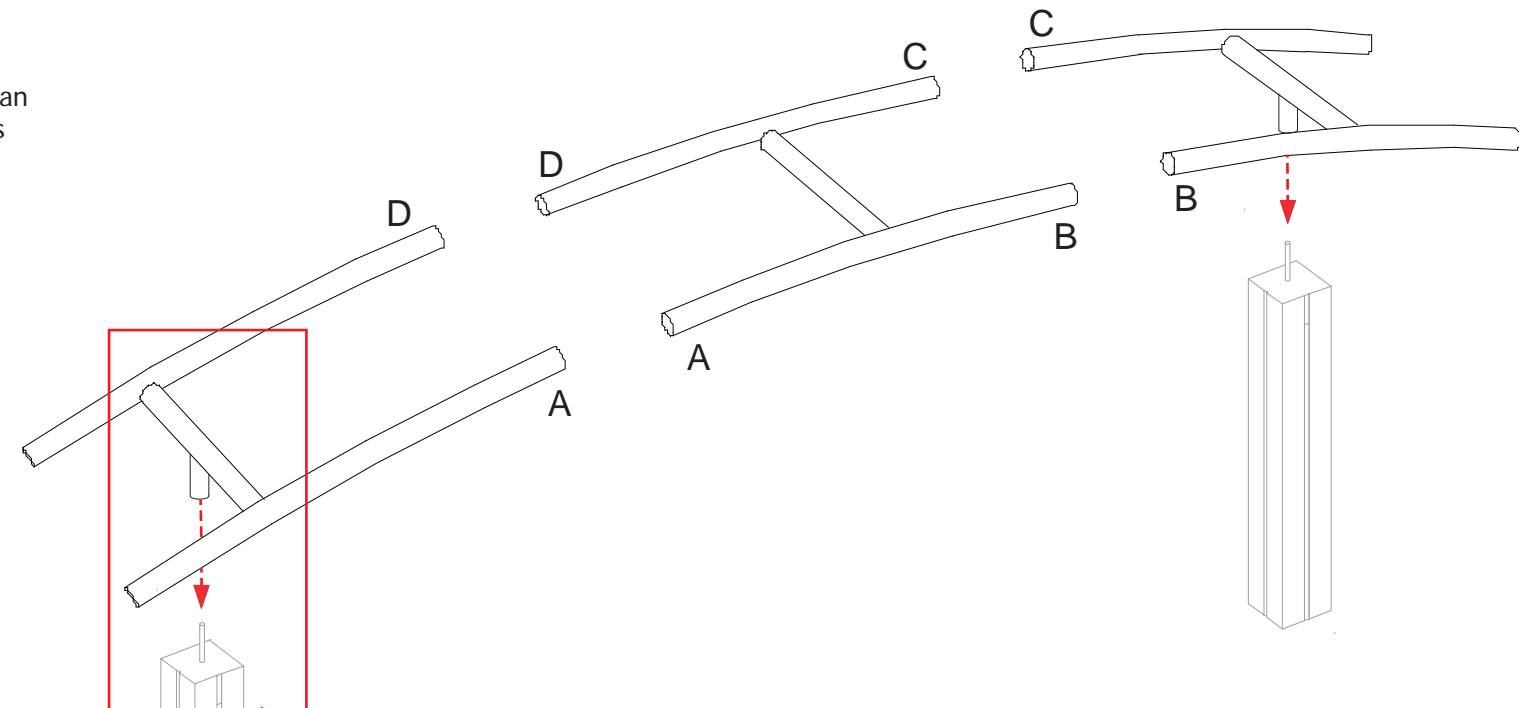
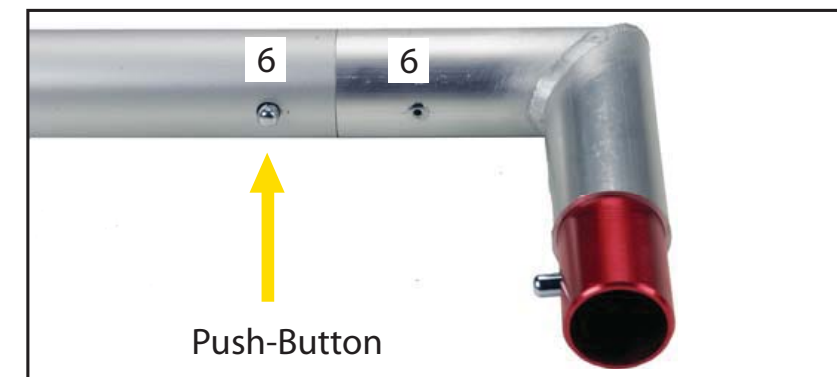

**WHEN DISASSEMBLING ALUMINUM EXTRUSION, TIGHTEN ALL SETSCREWS AND LOCKS TO PREVENT LOSS DURING SHIPPING**

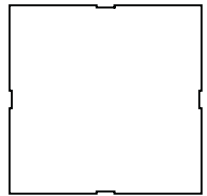

42”h Square Extrusion

Qty. : 4  
Located in Case : 1

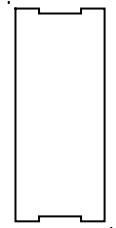

42”h Extrusion

Qty. : 4  
Located in Case : 2

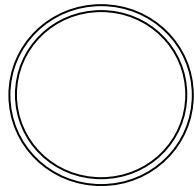

Tapered Counter Support

Qty. : 1  
Located in Case : 1

Tapered Counter Support

Qty. : 1  
Located in Case : 2

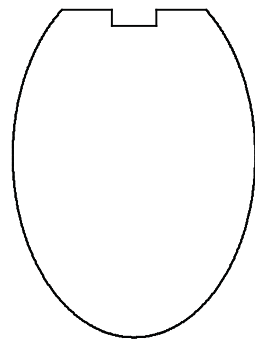

Workstation Counter Top

Qty. : 1  
Located in Case : 1

Workstation Counter Top

Qty. : 1  
Located in Case : 2

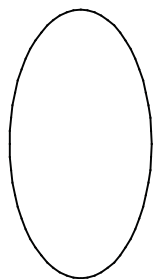

Oval Base Plate

Qty. : 1  
Located in Case : 1

Oval Base Plate

Qty. : 1  
Located in Case : 2

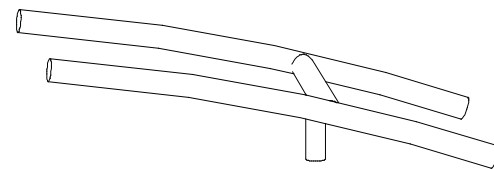

Curved Standard Canopy Piece

Located in Case : 1



Curved Standard Canopy Piece

Located in Case : 2

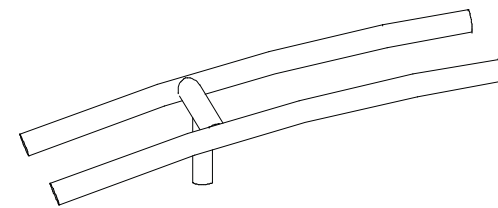

Curved Standard Canopy Piece

Located in Case : 2

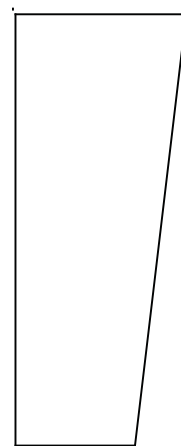

Upper Wing panel

Qty. : 2  
Located in Case : 1

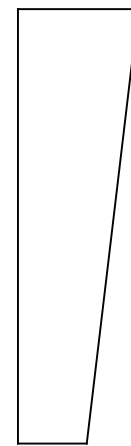

Lower Wing Panel

Qty. : 2  
Located in Case : 1

Additional Accessories:

Graphic \_\_\_\_\_ in case 1

Setup Hardware \_\_\_\_\_ in case 1

\_\_\_\_\_ in case \_\_\_\_\_

\_\_\_\_\_ in case \_\_\_\_\_

\_\_\_\_\_ in case \_\_\_\_\_

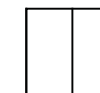

A10 Clamps for Wings

Qty. : 8  
Located in Case : 1

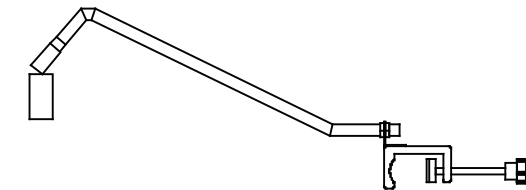

Halogen Light

Qty. : 3  
Located in Case : 1

WHEN DISASSEMBLING ALUMINUM EXTRUSION, TIGHTEN ALL SETSCREWS AND LOCKS TO PREVENT LOSS DURING SHIPPING