

# euro It | HYBRIDS

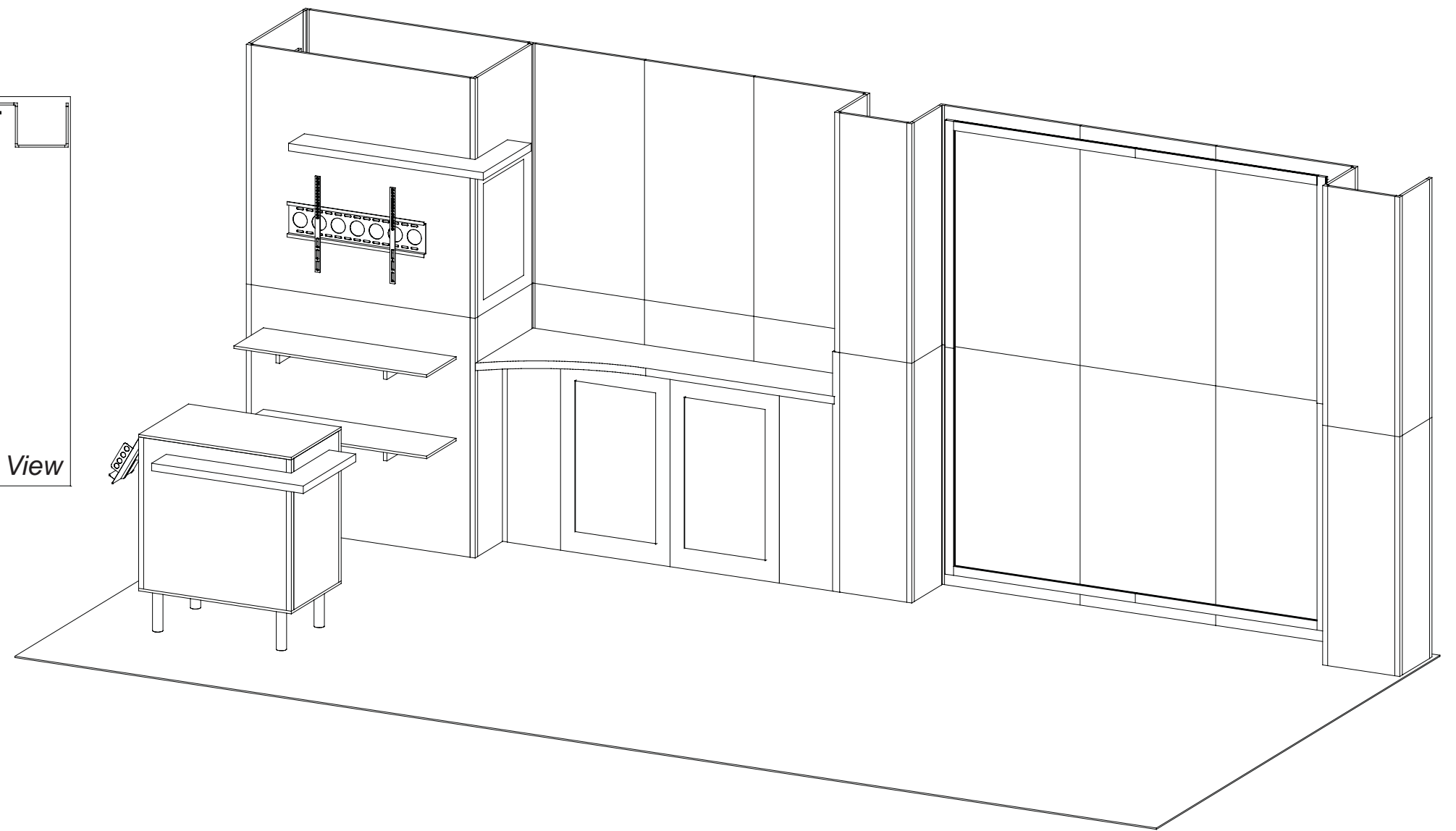
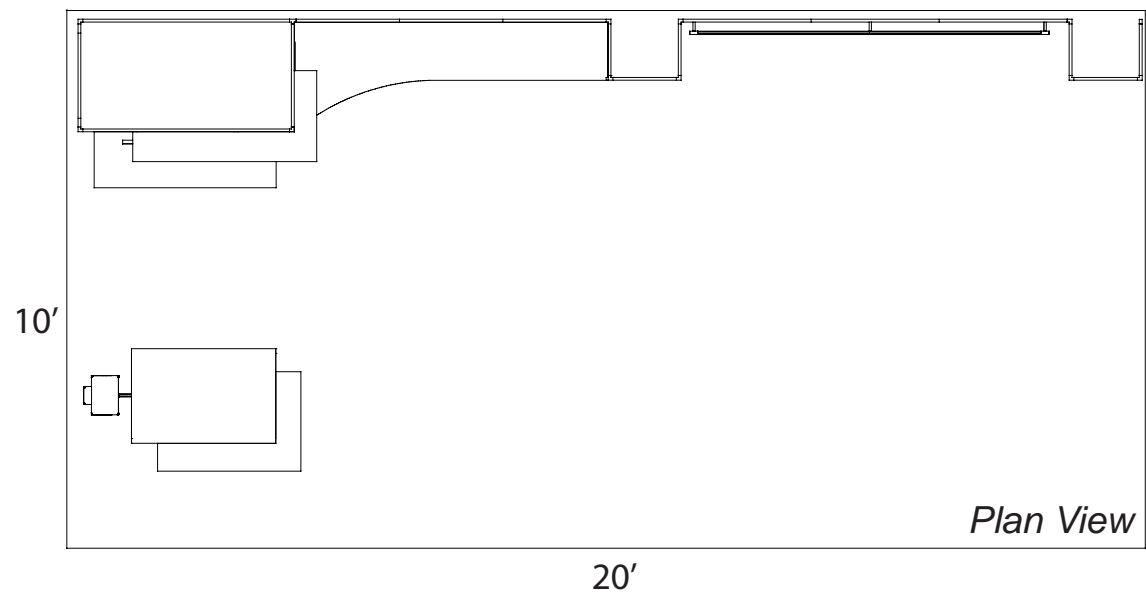

# euro lt | HYBRIDS

## Euro LT Hybrids General Setup Instructions

### Using Your Setup Instructions

The Euro LT Hybrids Setup Instructions are created specifically for your configuration. They are laid out sequentially in levels, including exploded views, and a logical series of detailed steps to assemble the main structure and components. We encourage you to study the instructions **before** attempting to assemble your exhibit.

### Cleaning and Packing Your Display

- 1) When cleaning laminate countertops or panels use mild cleansers and a soft material such as cotton.
- 2) Keep all display components away from extreme heat and long exposure to sunlight to avoid warping and fading.
- 3) Retain all packing material. It will make re-packing much easier and will reduce the likelihood of shipping damage.

Level 1 = Blue  
 Level 2 = Red  
 Level 3 = Green  
 Level 4 = Black

#### Color Code

The top clip is color coded to distinguish the level. The color coded clip also contains the numbered label

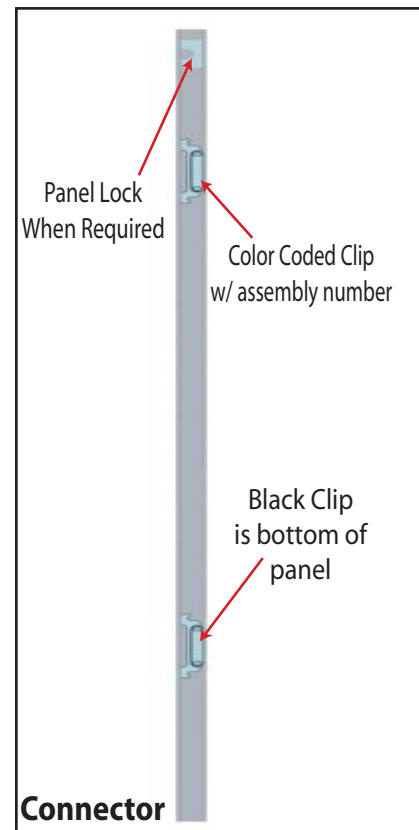

Each component has 2 clips, the lower clip is ALWAYS black..

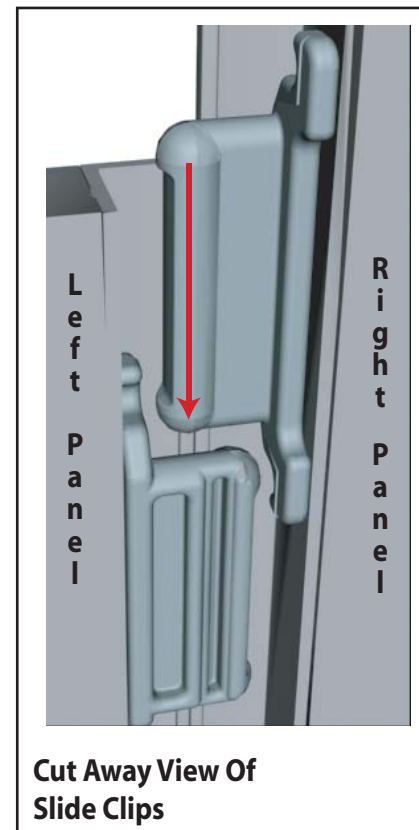

Components connect together by aligning them and sliding downward connecting clips together.

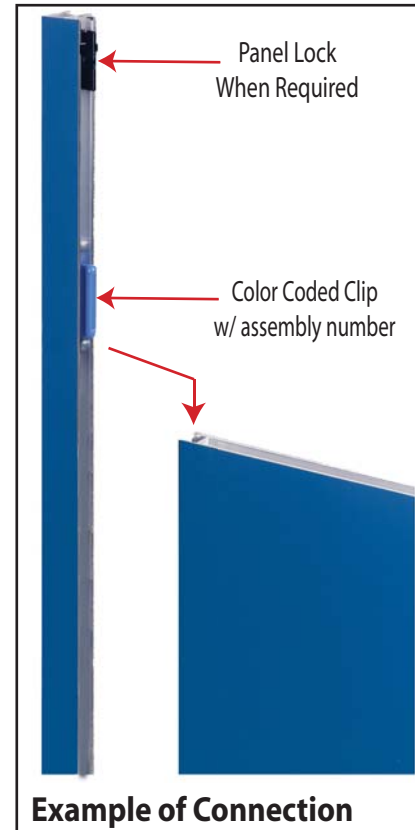

Configurations are assembled from left to right, usually starting with #1 and following the numbered sequence.

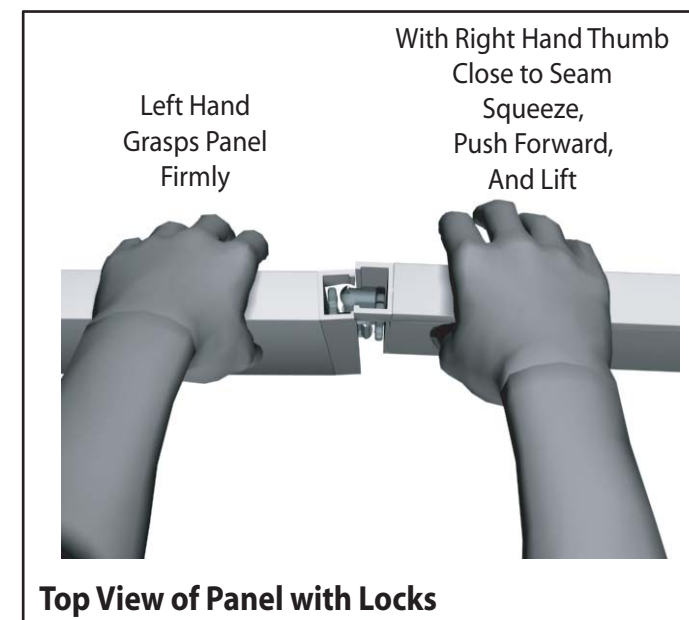

The first level of components contains panel locks that are located at the top of the panel for extra stability and a seamless connection. When disassembling panels, twist top connection slightly and lift right panel upward.

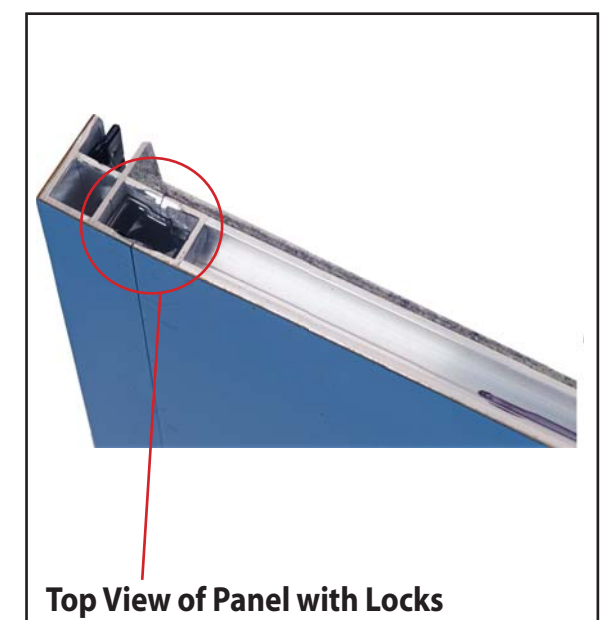

866.652.2100

| Item Number | Description                                       | Item Number | Description                    |
|-------------|---|-------------|--------------------------------|
| 1           | 23" w x 47.5" h Flat Panel w/ Connector Attached  | 17          | 11.19" w x 38" h Flat Panel    |
| 2           | 47.5" h 90° Connector                             | 18          | 47.5" h T Connector            |
| 3           | 46" w x 47.5" h Flat Panel w/ Connectors Attached | 19          | 14.125" w x 47.4" h Flat Panel |
| 4           | 47.5" h 90° Connector                             | 20          | 47.5" h 90° Connector          |
| 5           | Lower Section Door Panel                          | 21          | 11.5" w x 47.5" h Flat Panel   |
| 5a          | Door Stop   | 22          | 47.5" h 90° Connector          |
| 6           | 47.5" h 90° Connector                             | 23          | 28.5" w x 47.5" h Flat Panel   |
| 7A          | 46" w x 47.5" h Flat Panel w/ Door                | 24          | 28.5" w x 47.5" h Flat Panel   |
| 8           | 47.5" h T Connector                               | 25          | 28.5" w x 47.5" h Flat Panel   |
| 9           | 23" w x 47.5" h Flat Panel                        | 26          | 47.5" h 90° Connector          |
| 10          | 23" w x 47.5" h Flat Panel                        | 27          | 11.5" x 47.5" h Flat Panel     |
| 11          | 23" w x 47.5" h Flat Panel                        | 28          | 47.5" h 90° Connector          |
| 12          | 47.5" h 90° Connector                             | 29          | 14.125" w x 47.5" h Flat Panel |
| 13          | 11.5" w x 47.5" h Flat Panel                      | 30          | 47.5" h 90° Connector          |
| 14          | 11.19" w x 38" h Flat Panel                       | 31          | 11.5" x 47.5" h Flat Panel     |
| 14a         | 38" h 180° Connector                              | 32          | 47.5" h End Cap                |
| 15          | 23" w x 38" h Flat Panel w/ Door                  |             |                                |
| 16          | 23" w x 38" h Flat Panel w/ Door                  |             |                                |

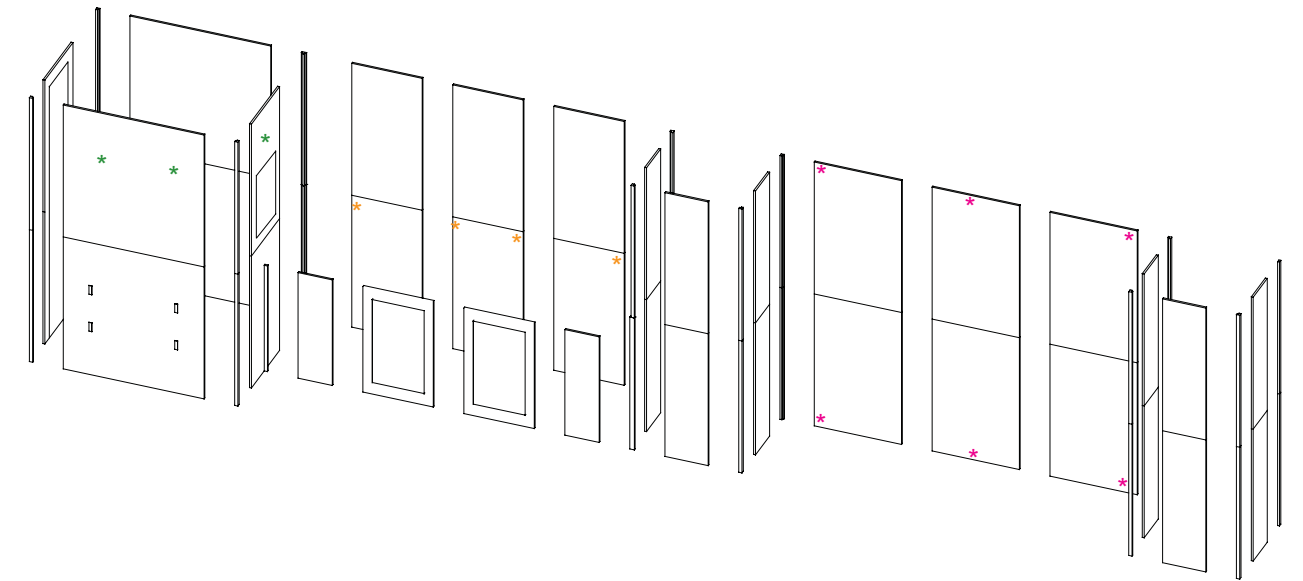

Steps:

- 1) Assemble by starting at panel #1\* and continue in numerical order.

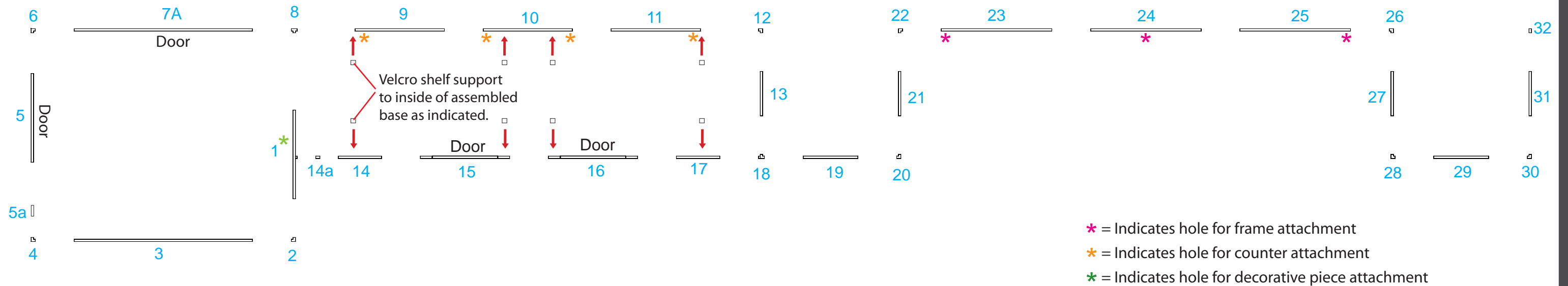

866.652.2100

| Item Number | Description                      | Item Number | Description                  |
|-------------|----------------------------------|-------------|------------------------------|
| 1           | 23"w x 47.5"h Flat Panel w/ Door | 18          | 47.5"h 90° Connector         |
| 2           | 47.5"h 90° Connector             | 19          | 14.125"w x 47.4"h Flat Panel |
| 3           | 46"w x 47.5"h Flat Panel         | 20          | 47.5"h 90° Connector         |
| 4           | 47.5"h 90° Connector             | 21          | 11.5"w x 47.5"h Flat Panel   |
| 5           | Upper Section Door Panel         | 22          | 47.5"h 90° Connector         |
| 6           | 47.5"h 90° Connector             | 23          | 28.5"w x 47.5"h Flat Panel   |
| 7           | 46"w x 47.5"h Flat Panel         | 24          | 28.5"w x 47.5"h Flat Panel   |
| 8           | 47.5"h T Connector               | 25          | 28.5"w x 47.5"h Flat Panel   |
| 9           | 23"w x 47.5"h Flat Panel         | 26          | 47.5"h 90° Connector         |
| 10          | 23"w x 47.5"h Flat Panel         | 27          | 11.5" x 47.5"h Flat Panel    |
| 11          | 23"w x 47.5"h Flat Panel         | 28          | 47.5"h 90° Connector         |
| 12          | 47.5"h 90° Connector             | 29          | 14.125"w x 47.5"h Flat Panel |
| 13          | 11.5"w x 47.5"h Flat Panel       | 30          | 47.5"h 90° Connector         |
|             |                                  | 31          | 11.5" x 47.5"h Flat Panel    |
|             |                                  | 32          | 47.5"h End Cap               |

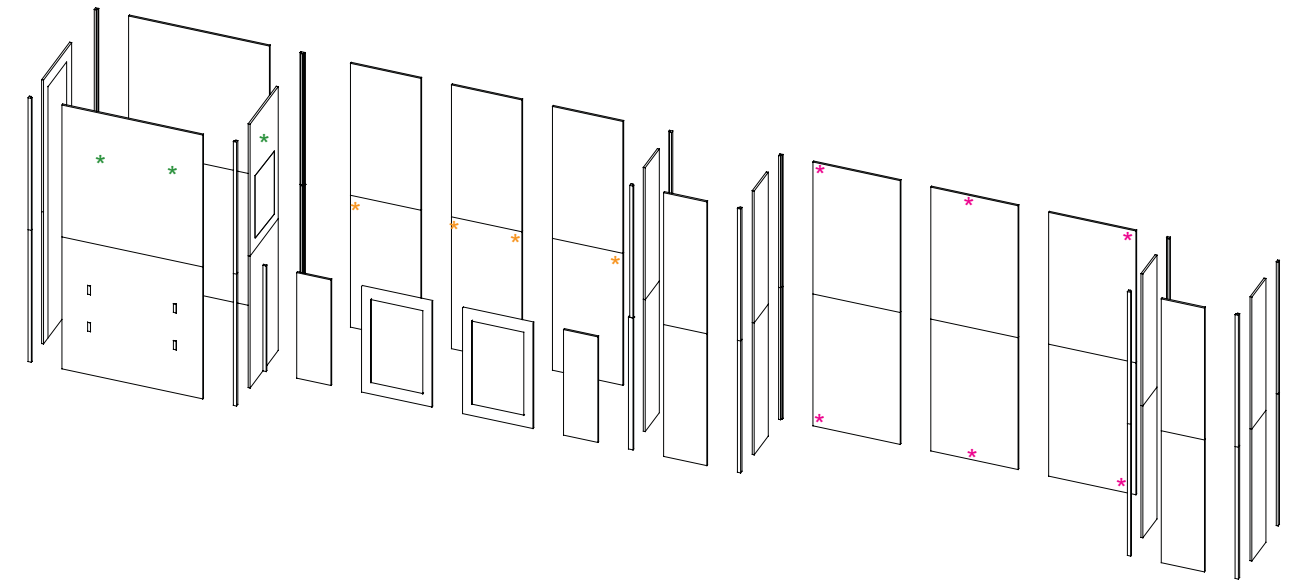

Steps:

1) Assemble by starting at panel #1\* and continue in numerical order.

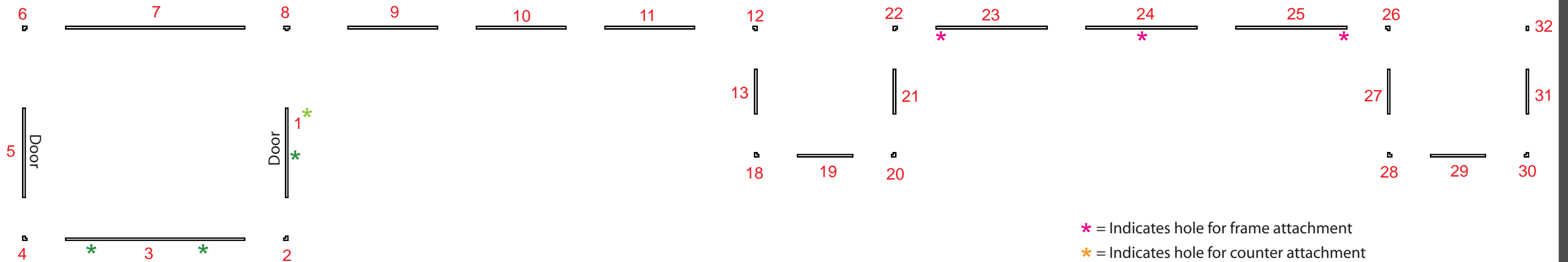

\* = Indicates hole for frame attachment  
 \* = Indicates hole for counter attachment  
 \* = Indicates hole for decorative piece attachment

866.652.2100

| Item Number | QTY. | Description         |
|-------------|------|---------------------|
| 1           | 1    | 45" h Extrusion     |
| 2           | 1    | 45" h Extrusion     |
| 3           | 1    | 45" h Extrusion     |
| 4           | 1    | 45" h Extrusion     |
| 5           | 1    | 38.209" w Extrusion |
| 6           | 1    | 38.209" w Extrusion |
| 7           | 1    | 38.209" w Extrusion |
| 8           | 1    | 38.209" w Extrusion |

Steps:

- 1) Attach vertical extrusions together [1 to 2 and 3 to 4].
- 2) Attach horizontal extrusions together [5 to 6 and 7 to 8].
- 3) Attach horizontal assemblies between vertical assemblies as shown.

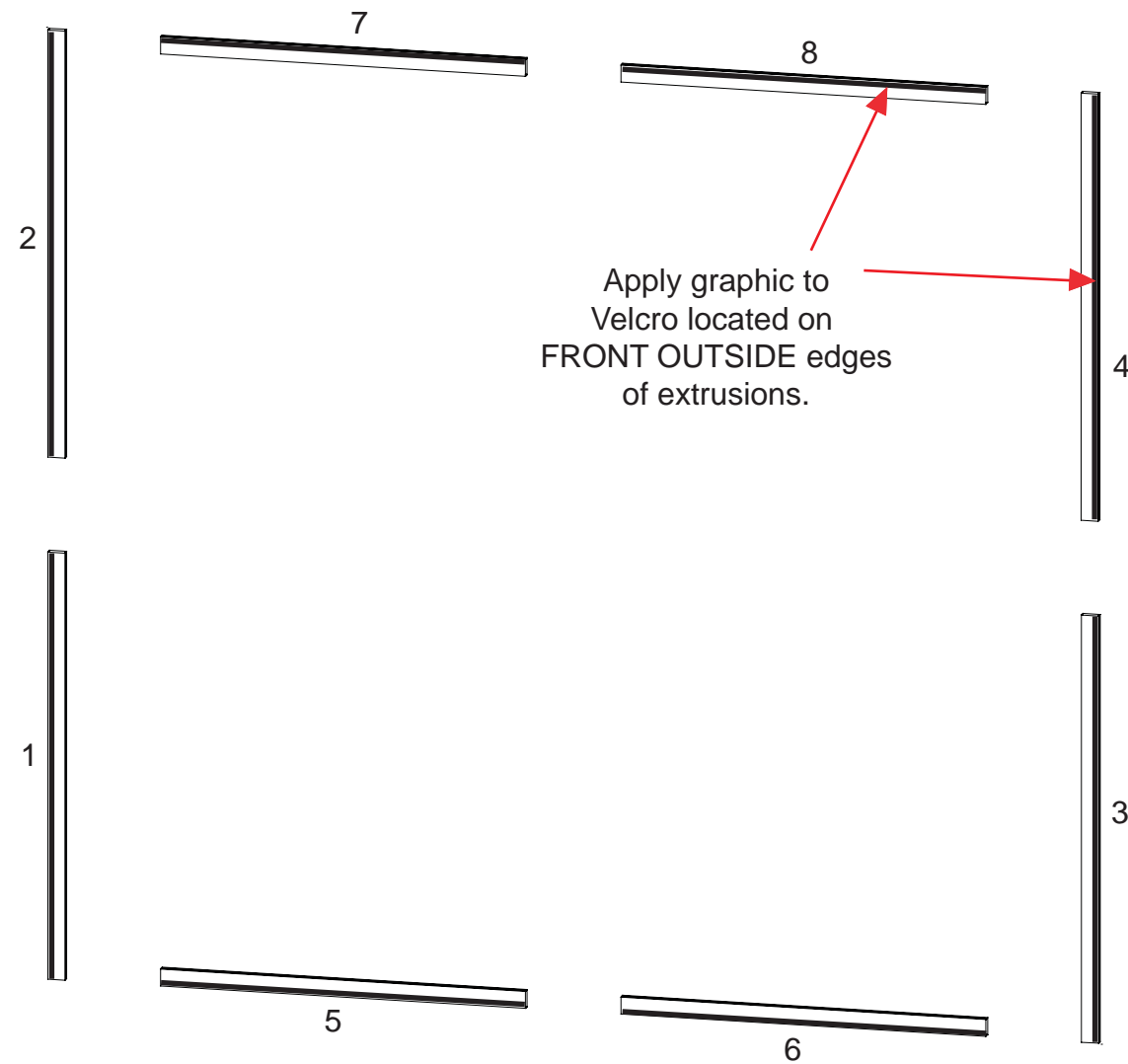
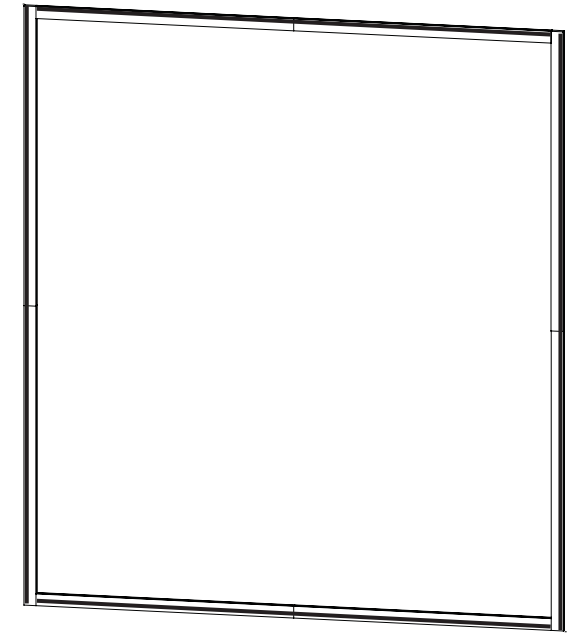

Apply graphic to  
Velcro located on  
FRONT OUTSIDE edges  
of extrusions.

Steps:

- 1) Place internal shelf atop shelf supports, then set counter top on assembled base and secure to backwall with thumbcrews.
- 2) Attach monitor mount to backwall as indicated.
- 3) Attach shelf with support extrusions attached to connectors, tighten locks to secure.
- 4) Attach assembled graphic frame to backwall using screw caps provided.
- 5) Attach decorative piece to backwall as indicated using thumbscrews provided.

Shelf Attachment

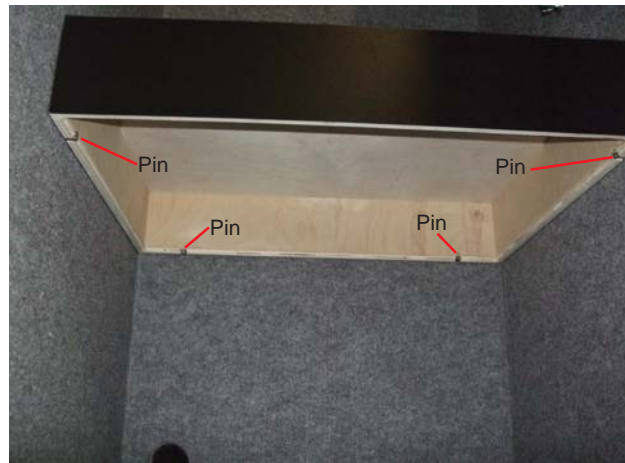

Attach pins to inside of storage room, then set shelf atop pins.

Monitor Mount Attachment

Attach monitor brackets to back of monitor.

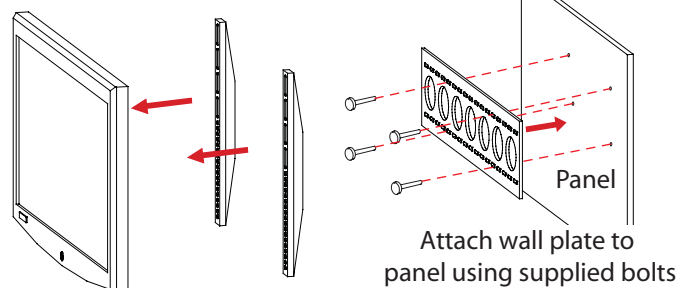

Hook monitor brackets over top of wall plate, then secure with safety bolts to bottom of monitor brackets.

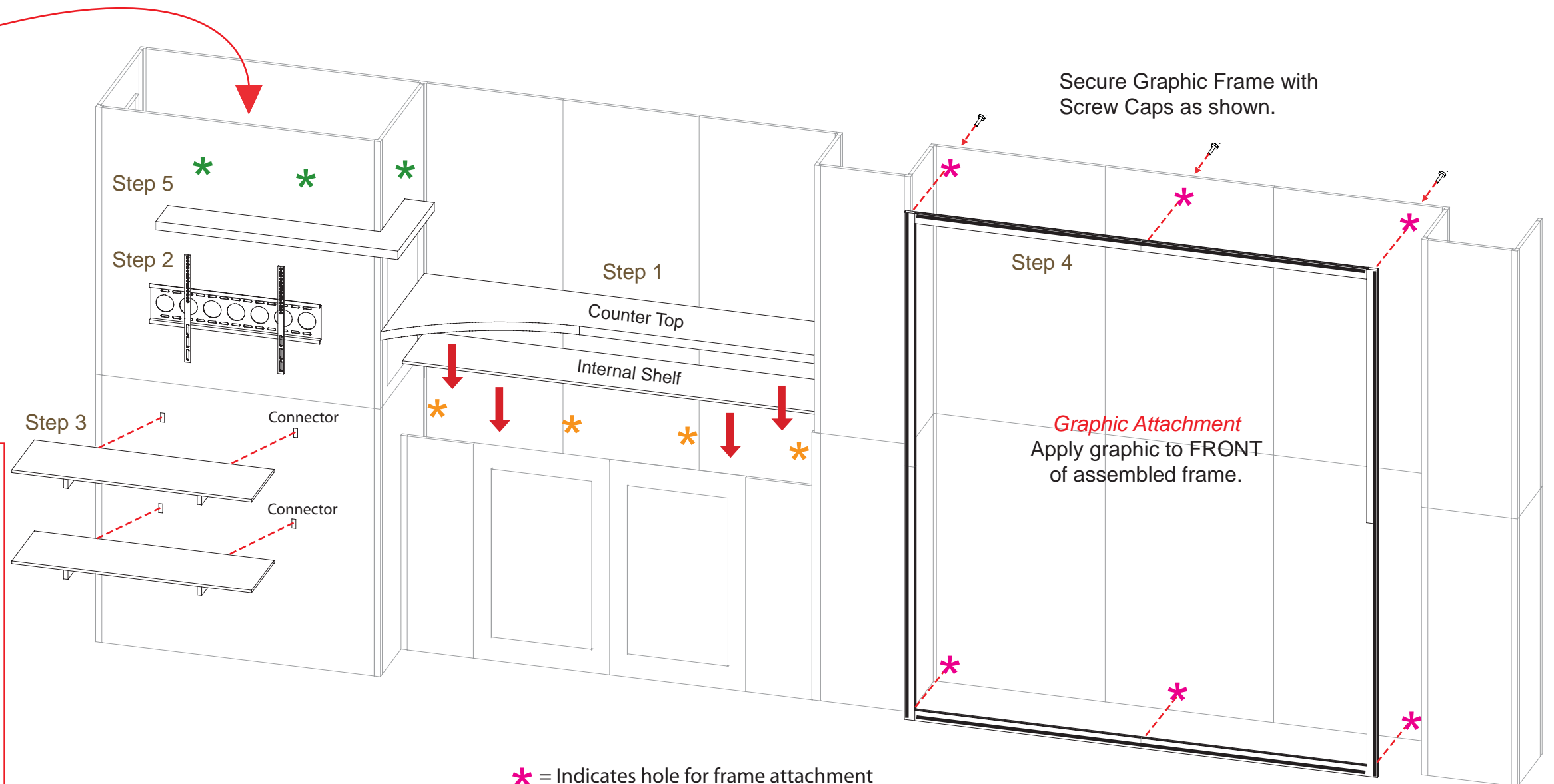

Secure Graphic Frame with Screw Caps as shown.

Step 4

*Graphic Attachment*  
Apply graphic to FRONT of assembled frame.

- \* = Indicates hole for frame attachment
- \* = Indicates hole for counter attachment
- \* = Indicates hole for decorative piece attachment

866.652.2100

| Item Number | Description                      |
|-------------|----------------------------------|
| 33          | 30" w x 30" h Flat Panel w/ Door |
| 34          | 30" h 90° Connector              |
| 35          | 19" w x 30" h Flat Panel         |
| 36          | 30" h 90° Connector              |
| 37          | 30" w x 30" h Flat Panel         |
| 38          | 30" h 90° Connector              |
| 39          | 19" w x 30" h Flat Panel         |
| 40          | 30" h 90° Connector              |

Steps:

- 1) Assemble by starting at panel #33 and continue in numerical order.
- 2) Attach legs to base using screws supplies as shown.
- 3) Place assembled pedestal from previous step atop base.
- 4) Velcro shelf supports to inside of pedestal base as shown.
- 5) Place internal shelf atop supports.
- 6) Attach decorative piece to pedestal base using thumbscrews as shown.
- 7) Set counter top on assembled pedestal

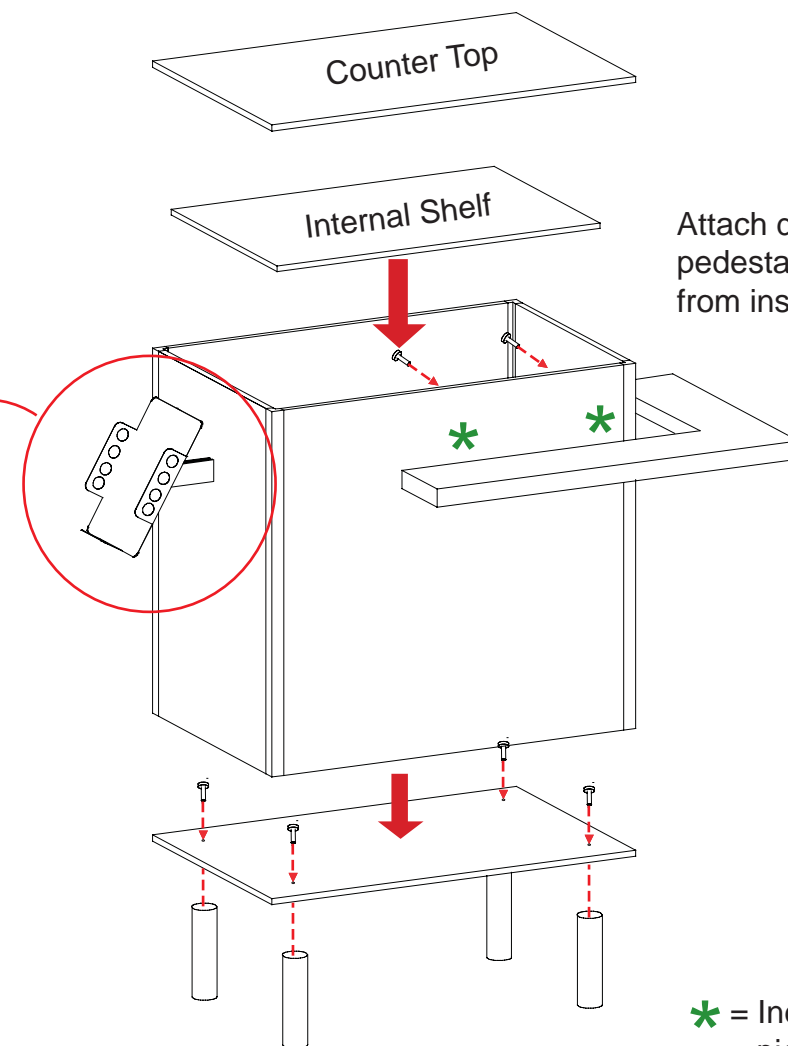
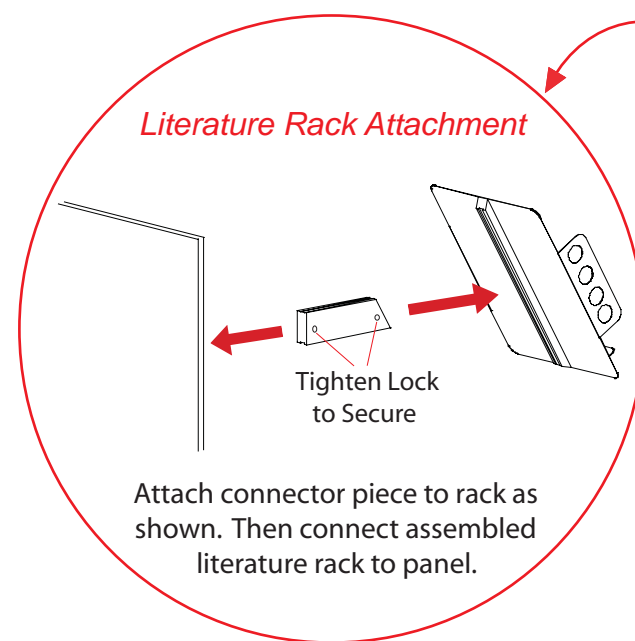
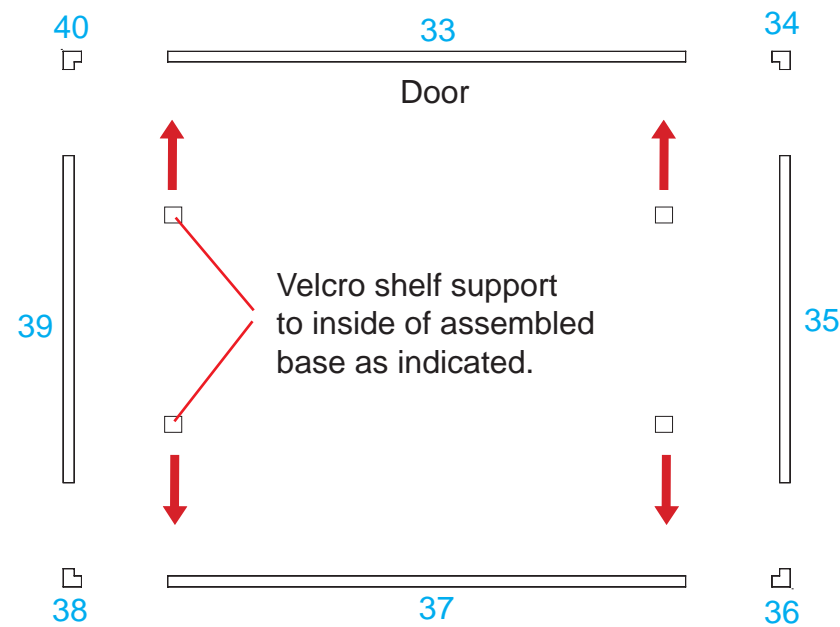
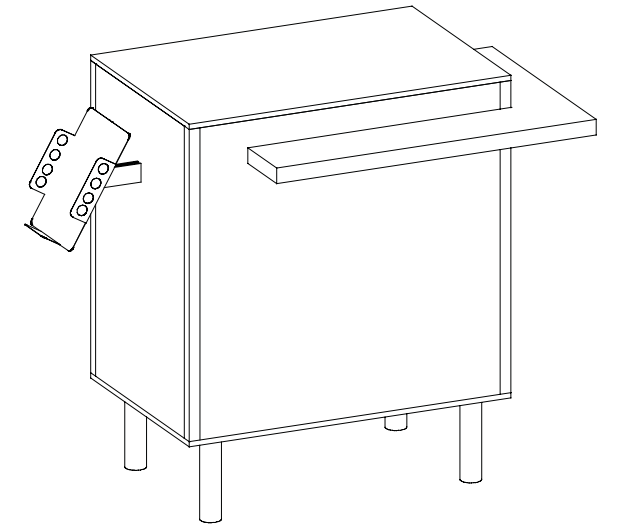

Attach decorative piece to assembled pedestal by attaching thumbscrews from inside of pedestal as shown.

\* = Indicates hole for decorative piece attachment

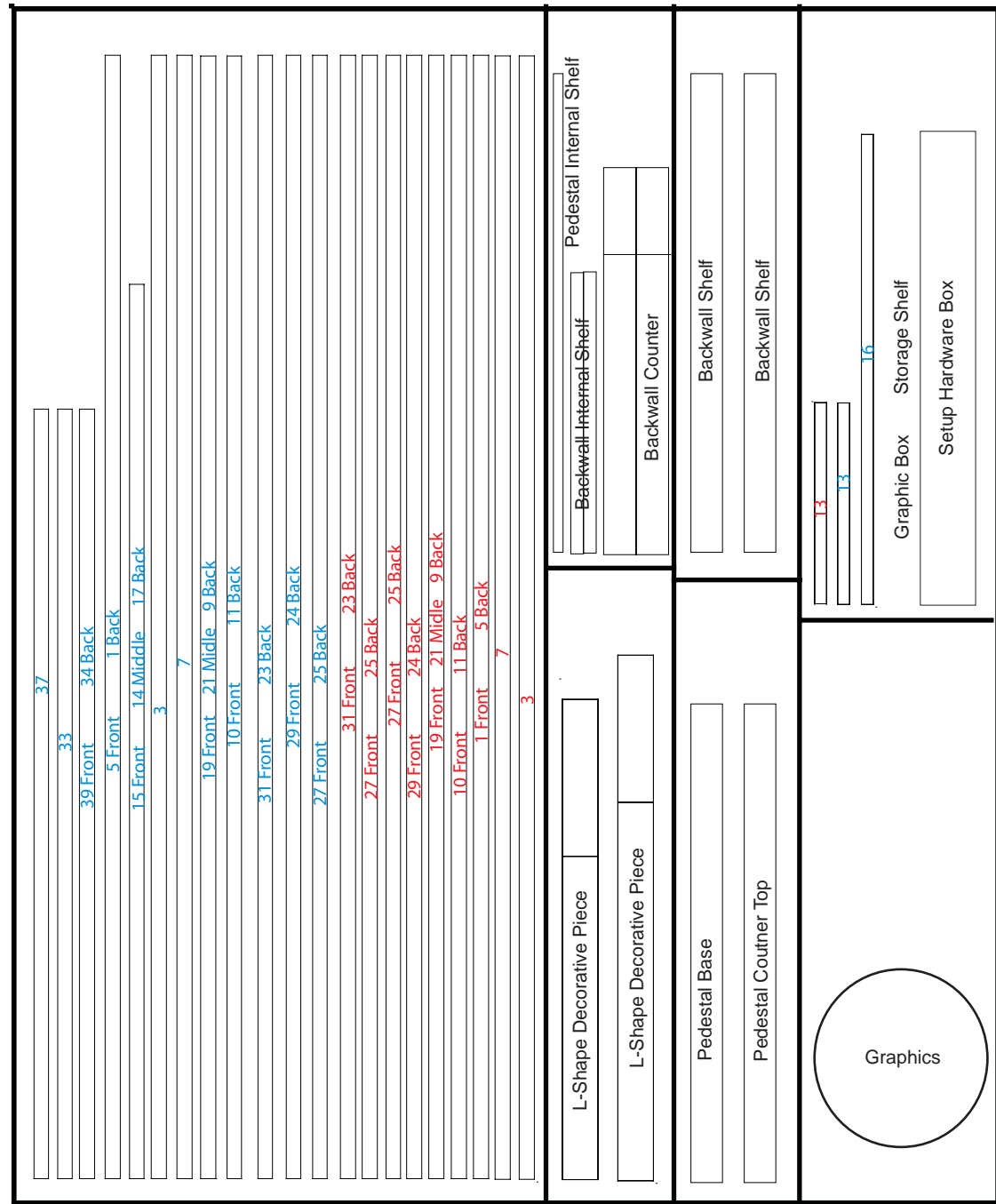

Setup Hardware Box



Front View

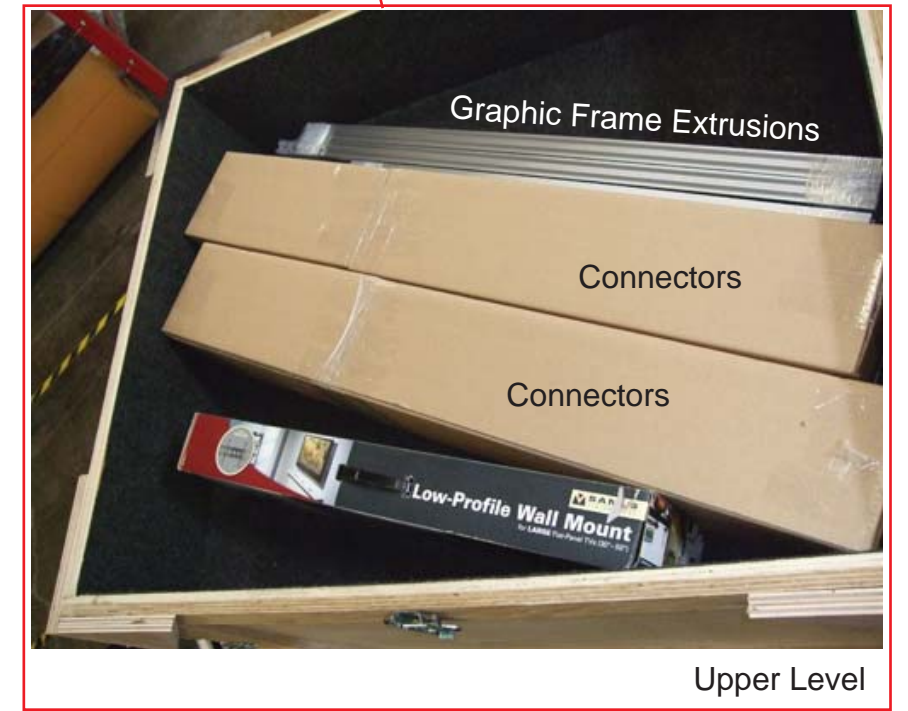

Upper Level