

Perfect 10 Hybrid Displays

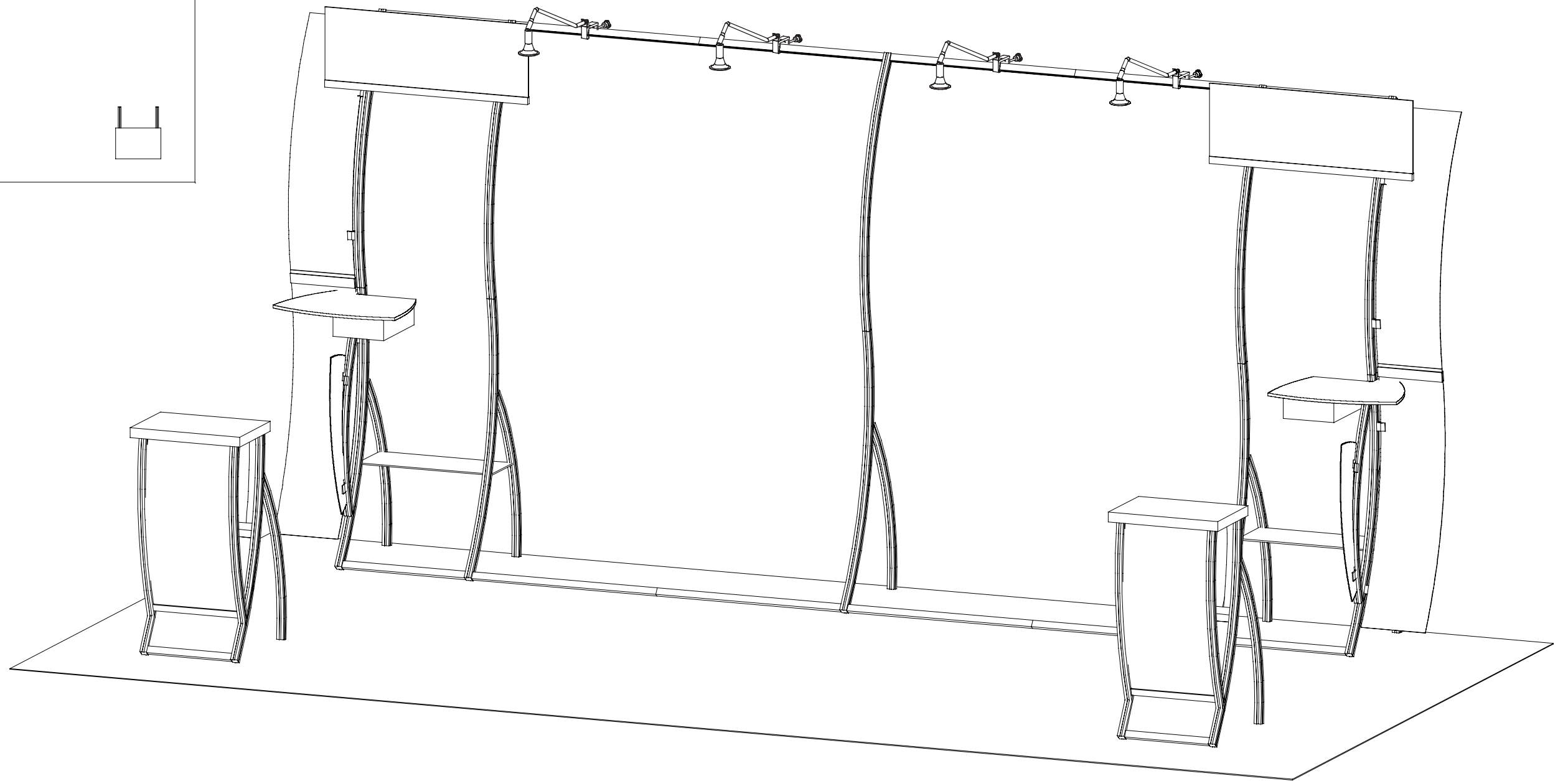
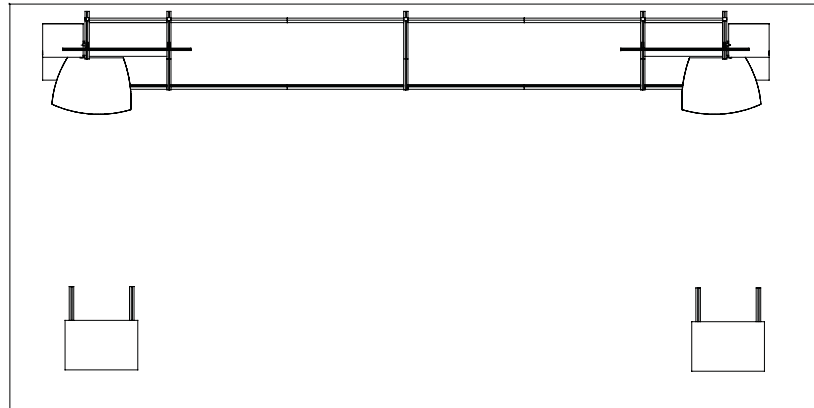

WHEN DISASSEMBLING TIGHTEN ALL KNOBS TO PREVENT LOSS DURING SHIPPING

866.652.2100

| Part Number | Description |
|-------------|--|
| 1 | Left Leg Assembly w/ A10 Clamps Attached |
| 2 | Middle Leg Assembly |
| 3A | Upper Curved Vertical w/ A10 Clamps Attached |
| 3 | Upper Curved Vertical |
| 4 | 23" w Horizontal |



Step 1:

NOTE: Can be assembled either face down on floor then lifted upright or upright as shown in drawings.

- A) Connect vertical leg assemblies [1 and 2] together by connecting horizontal extrusions [4] between assemblies tightening BLACK knobs on backside of extrusion making sure Velcro faces toward BACK and placing it about one inch up from bottom and tightening.
- B) Connect vertical extrusions [3 and 3A] to leg assemblies [1 and 2] using vertical connection bar as shown.
- C) Connect upper horizontal extrusion [4] between verticals [3 and 3A] placing it about one inch down from top.

NOTE: Make sure the lock is flush with extrusion before tightening. If lock will not fully engage, gently rock lock and extrusion while turning knob until lock fully opens.

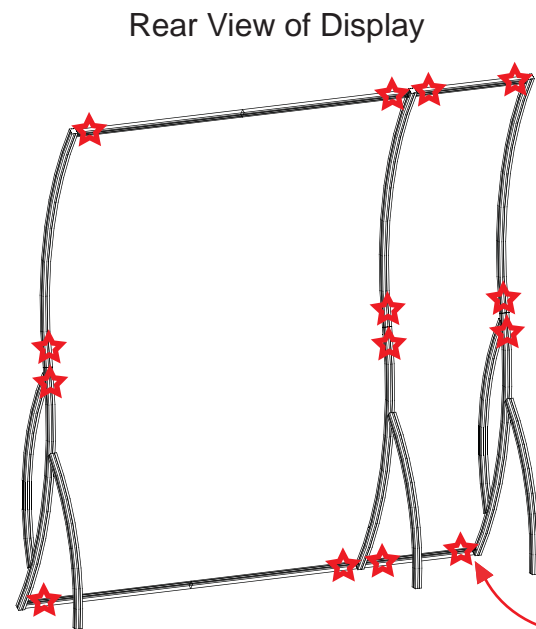

STAR indicates location of knobs on BACKSIDE of unit.

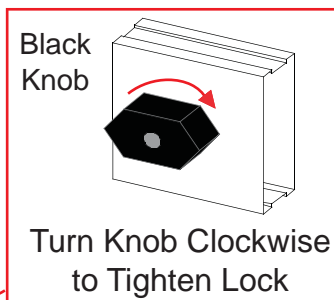

Turn Knob Clockwise to Tighten Lock

Step 1

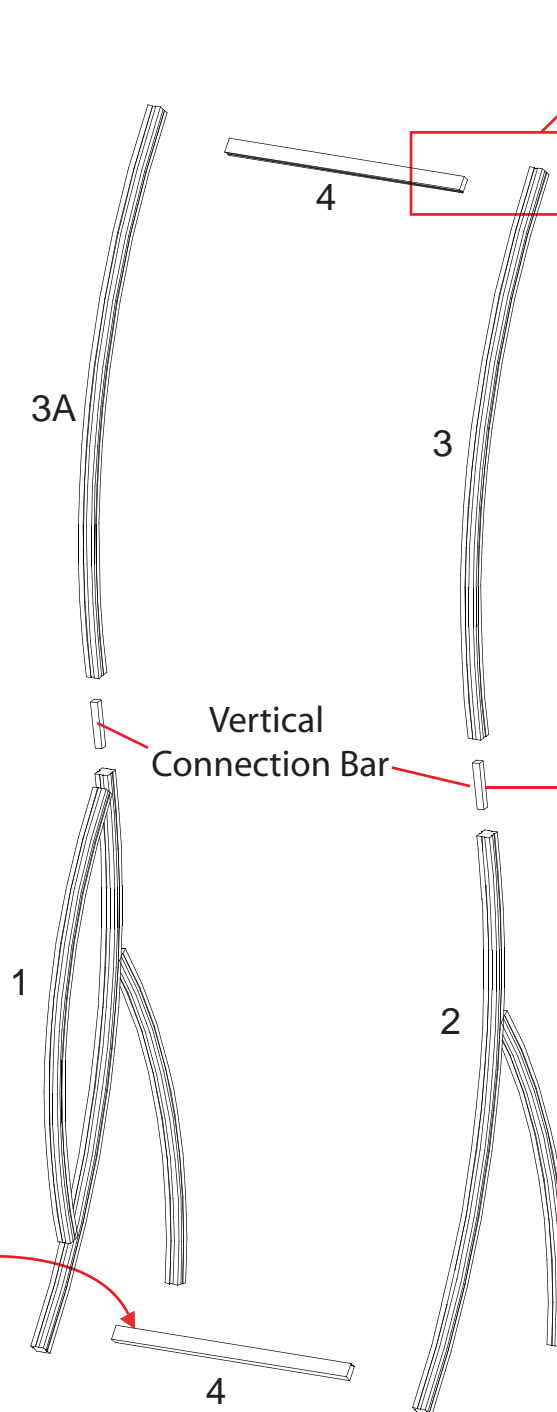

NOTE: When assembling horizontals they should be placed approximately one inch from TOP and BOTTOM.

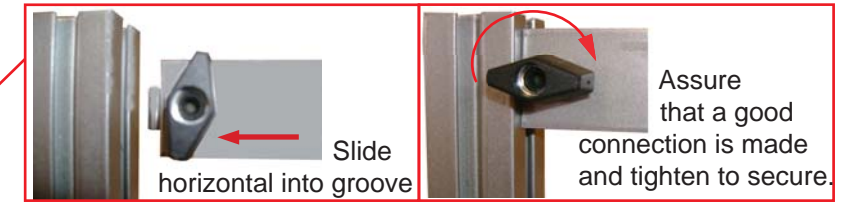

Slide Connection Bar into lower leg assembly. Slide upper vertical over bar and secure both.

Step stool may be required for assembly.



WHEN DISASSEMBLING TIGHTEN ALL KNOBS TO PREVENT LOSS DURING SHIPPING

| Part Number | Description |
|-------------|---|
| 5 | Right Leg Assembly w/ A10 Clamps Attached |
| 6 | Upper Curved Vertical |
| 7 | 69" w Horizontal w/ Hinge Facing UP |
| 8 | 69" w Horizontal w/ Hinge Facing DOWN |



Step 2:
NOTE: Can be assembled either face down on floor then lifted upright or upright as shown in drawings.

- A) Connect vertical extrusion [6] to leg assembly [5] using vertical connection bar as shown.
- B) Connect horizontal extrusions [7 and 8] between vertical assemblies by tightening BLACK knobs on backside of extrusion making sure Velcro faces toward BACK.

NOTE: Make sure the lock is flush with extrusion before tightening. If lock will not fully engage, gently rock lock and extrusion while turning knob until lock fully opens.

NOTE: When assembling horizontals they should be placed approximately one inch from TOP and BOTTOM.

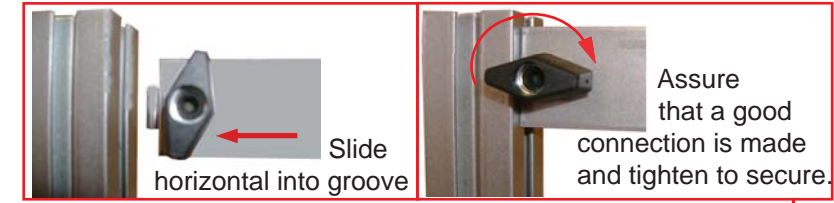

Step 2

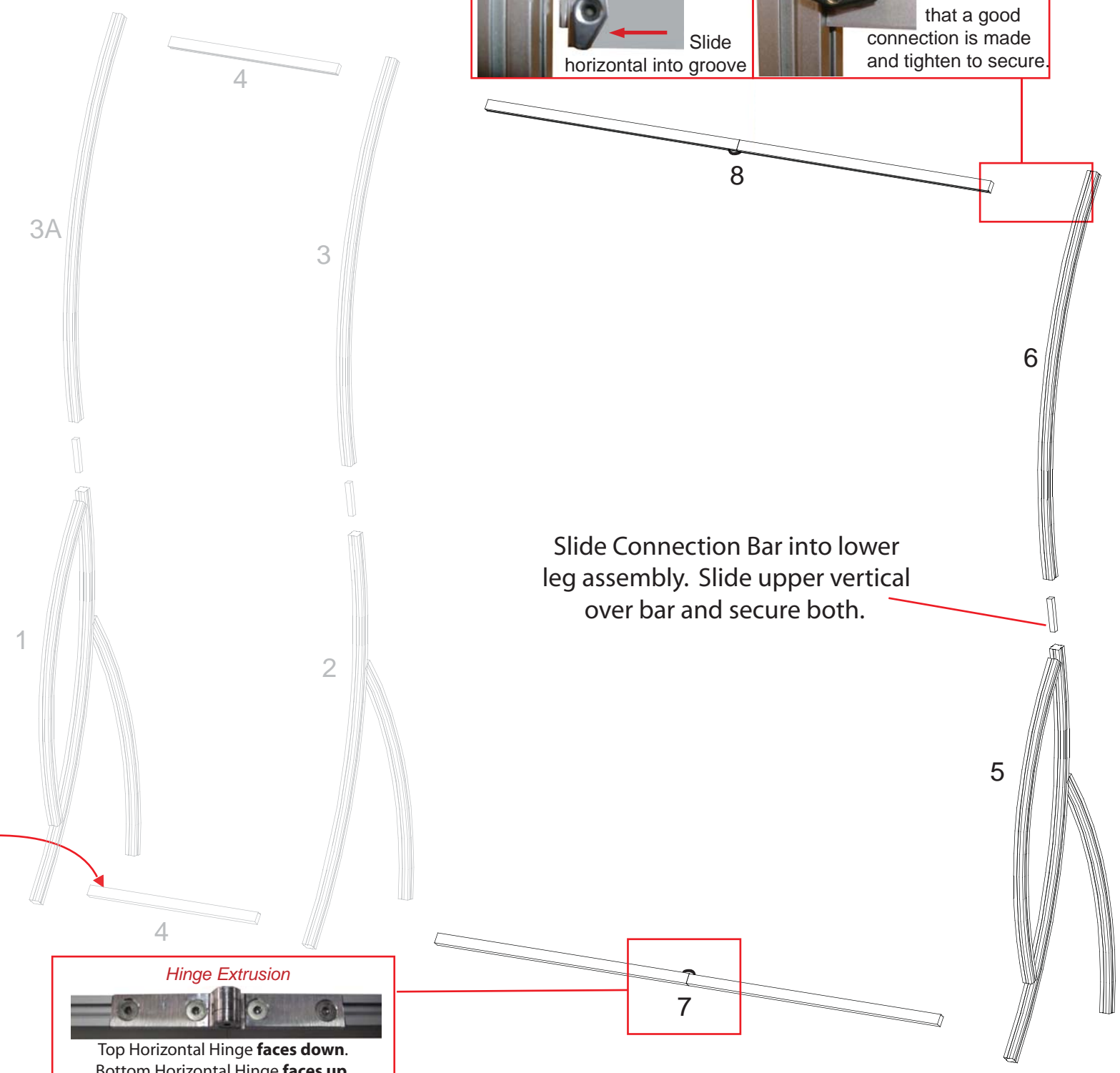

Slide Connection Bar into lower leg assembly. Slide upper vertical over bar and secure both.

Rear View of Display

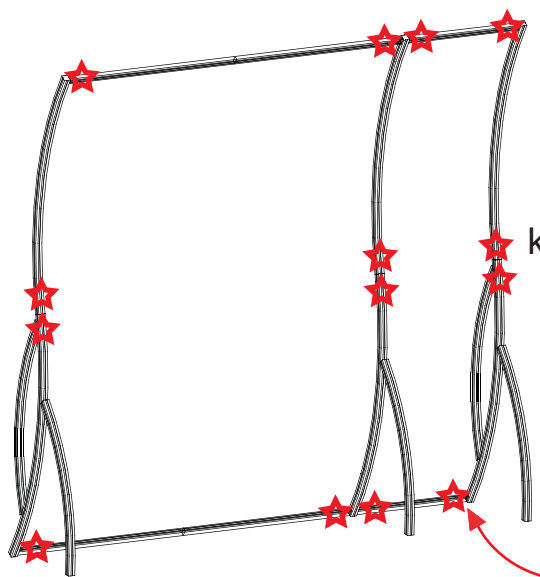

STAR indicates location of knobs on BACKSIDE of unit.

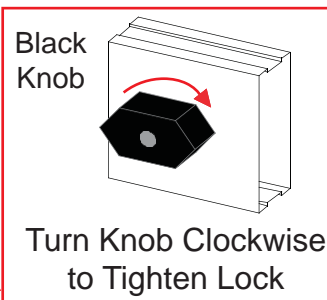

Hinge Extrusion



WHEN DISASSEMBLING TIGHTEN ALL KNOBS TO PREVENT LOSS DURING SHIPPING

866.652.2100

| Part Number | Description |
|-------------|--|
| 9 | 69" w Horizontal w/ Hinge Facing UP |
| 10 | 69" w Horizontal w/ Hinge Facing DOWN |
| 11 | Middle Leg Assembly |
| 12 | Right Leg Assembly w/ A10 Clamps Attached |
| 13A | Upper Curved Vertical w/ A10 Clamps Attached |
| 13 | Upper Curved Vertical |
| 14 | 23" w Horizontal |

NOTE: When assembling horizontals they should be placed approximately one inch from TOP and BOTTOM.



Step 1:
NOTE: Can be assembled either face down on floor then lifted upright or upright as shown in drawings.

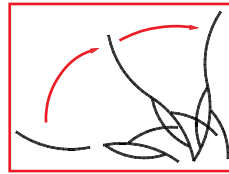

- A) Connect vertical leg assemblies [11 and 13] together by connecting horizontal extrusions [15] between assemblies tightening BLACK knobs on backside of extrusion making sure Velcro faces toward BACK and placing it about one inch up from bottom and tightening.
- B) Connect vertical extrusions [12 and 14] to leg assemblies [11 and 13] using vertical connection bar as shown.
- C) Connect upper horizontal extrusion [15] between verticals [12 and 14] placing it about one inch down from top.
- D) Connect horizontal extrusions [9 and 10] between vertical assemblies by tightening BLACK knobs on backside of extrusion making sure Velcro faces toward BACK.

NOTE: Make sure the lock is flush with extrusion before tightening. If lock will not fully engage, gently rock lock and extrusion while turning knob until lock fully opens.

Step 3

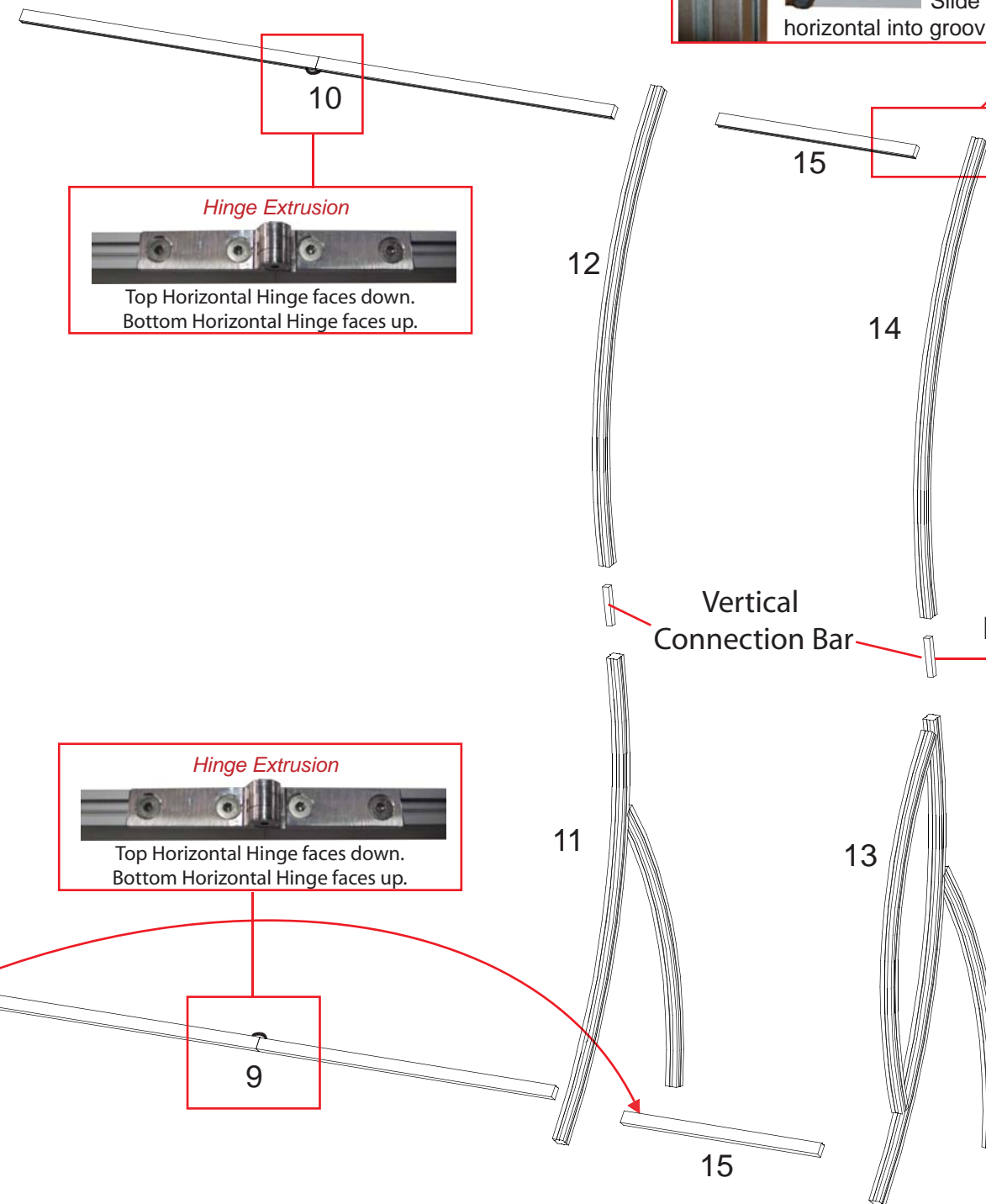

Vertical Connection Bar
Slide Connection Bar into lower leg assembly. Slide upper vertical over bar and secure both.

Step stool may be required for assembly.



Rear View of Display

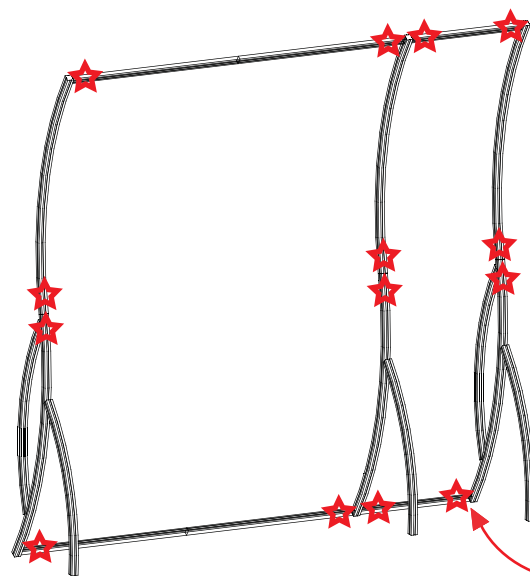

STAR indicates location of knobs on BACKSIDE of unit.

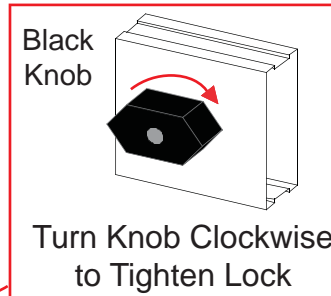

WHEN DISASSEMBLING TIGHTEN ALL KNOBS TO PREVENT LOSS DURING SHIPPING



Decorative Blade Attachment (if accidentally removed)
Slide A10 Clamp into groove of square extrusion.



A10

When desired location is found, tighten set screw to secure.



Set-Screw

Tighten black plastic set screw to secure Wing in place.



Black Plastic Set-screw

Attach decorative wing and blades to A10's attached to Backwall as shown.

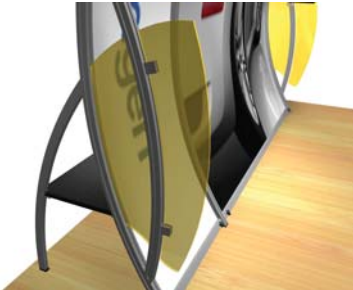
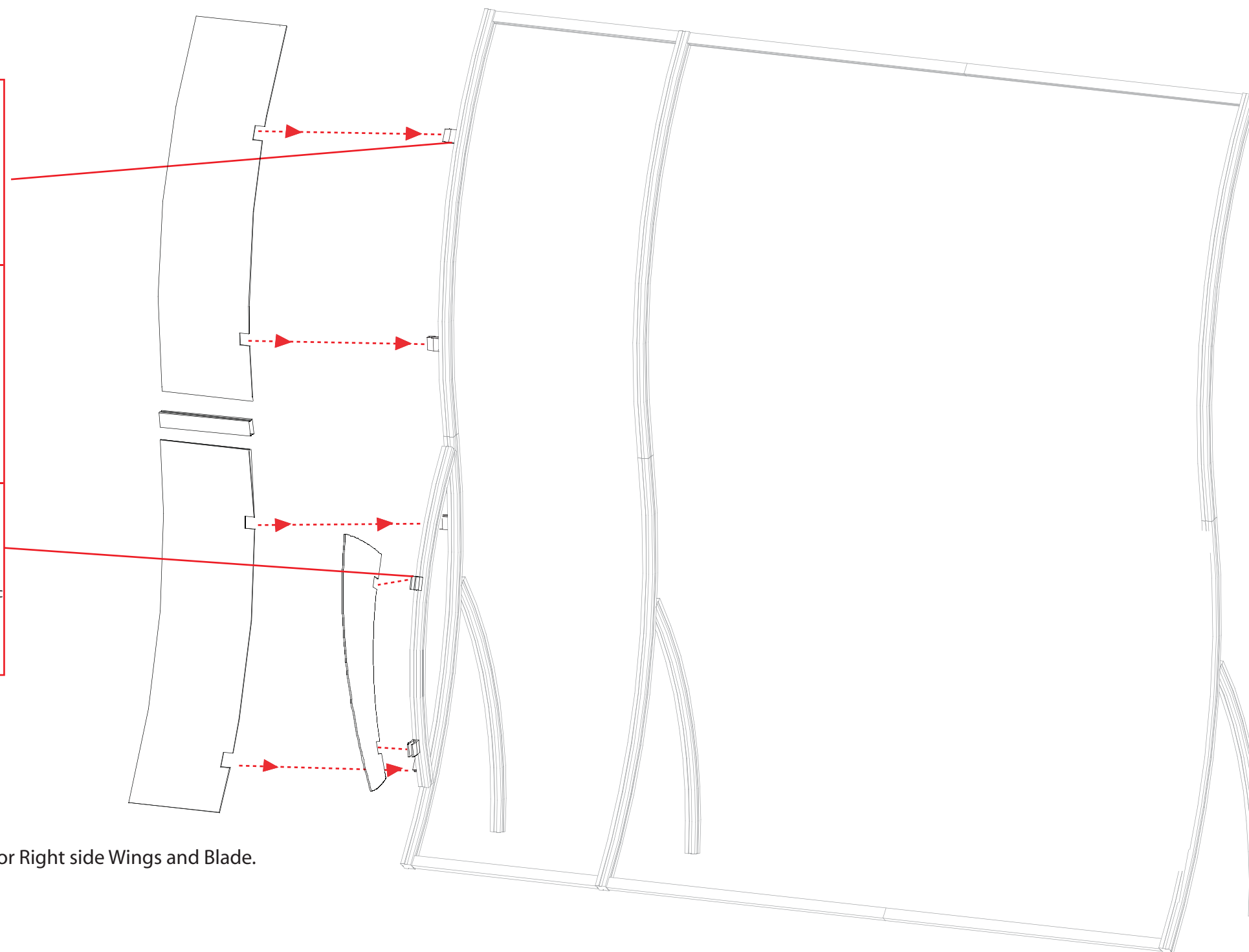



Hex Key Tool



(if necessary)

Flathead Screwdriver



WHEN DISASSEMBLING TIGHTEN ALL KNOBS TO PREVENT LOSS DURING SHIPPING

866.652.2100

****REPEAT Steps for Header, Shelf, Cubby and Lights for the additional side of the 10 x 20 Configuration.**

Accessory Attachment

Attach Header support then Slide header into Groove

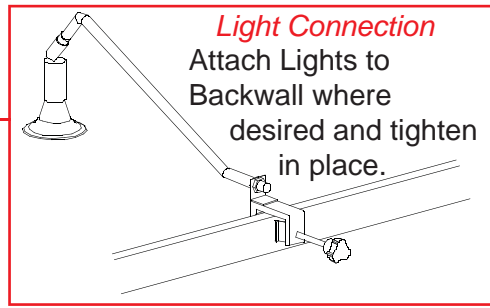
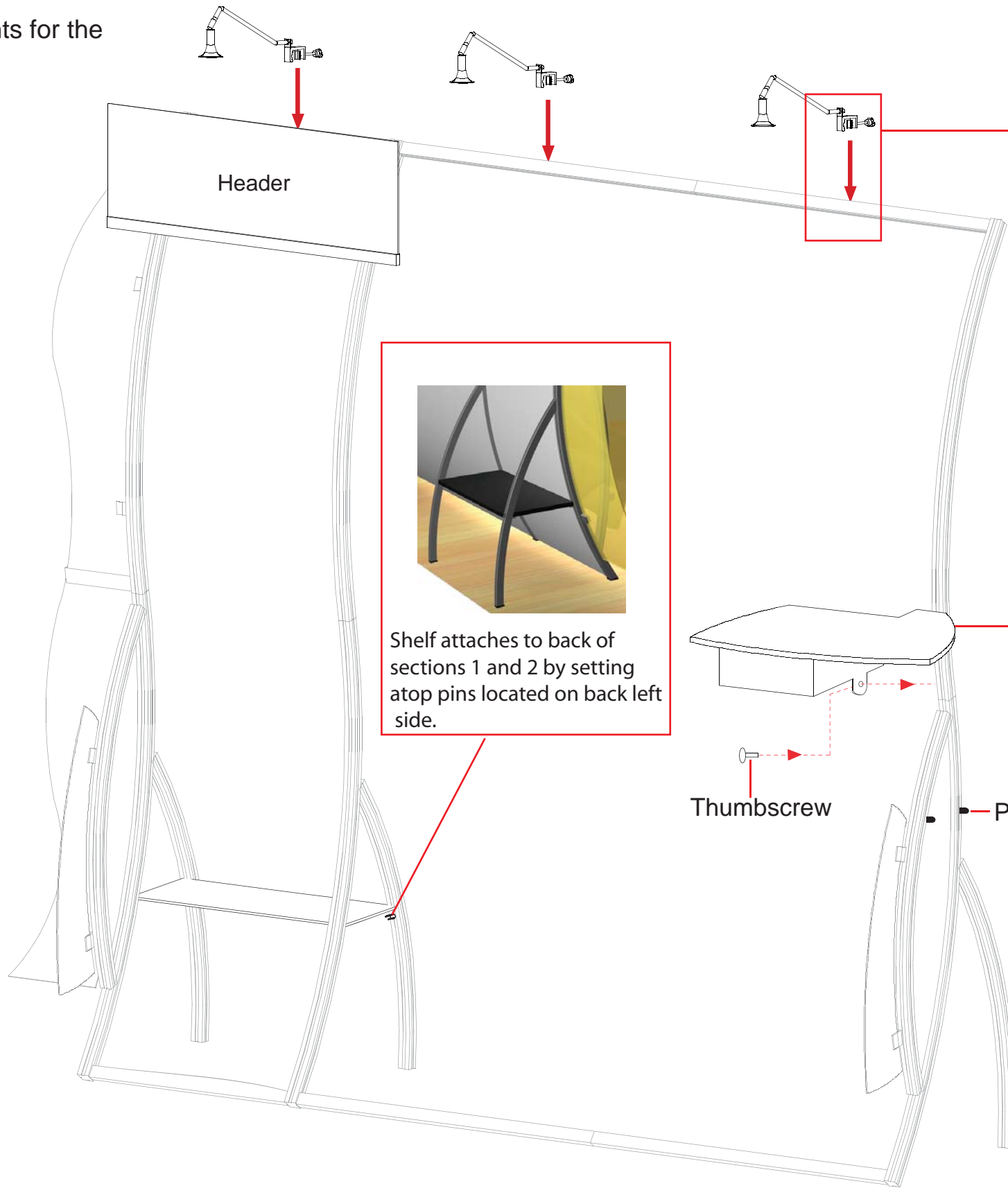
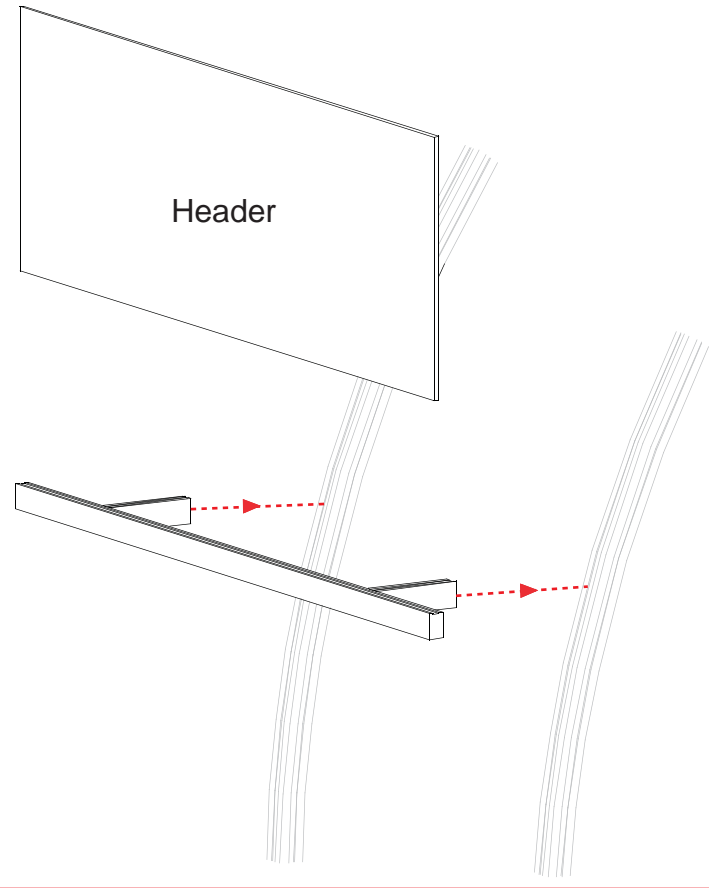

Light Connection
Attach Lights to Backwall where desired and tighten in place.



Shelf attaches to back of sections 1 and 2 by setting atop pins located on back left side.



Cubby Attachment

Shelf attaches to section 5 by setting atop pins located on right side and securing into place with thumbscrew on left.

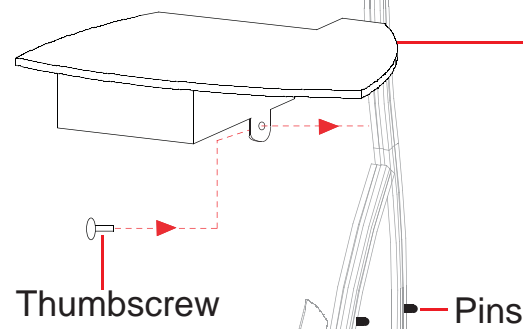

Thumbscrew Pins



Slide onto back pin first.
When attaching counter you will need to first slide shelf onto back pin then set down on front pin.

WHEN DISASSEMBLING TIGHTEN ALL KNOBS TO PREVENT LOSS DURING SHIPPING

| Part Number | Description |
|-------------|--------------------------------------|
| A | Left Leg Assembly |
| B | Right Leg Assembly |
| C | Horizontal Extrusion |
| D | Horizontal Extrusion w/ Door Stopper |

Step 1:

- A) Connect lower horizontal extrusion [C] between bottom of leg assemblies [A and B] as shown.
- B) Insert Laminated infill into grooves of leg assemblies [A and B].
- C) Attach extrusion door between leg assemblies [A and B] and atop laminated infill.
- D) Attach upper horizontal extrusion w/ door stopper [D] between leg assemblies [A and B], and set flush with top of legs [A and B].

**Repeat Steps for 2nd Pedestal.

NOTE: Make sure the lock is flush with extrusion before tightening. If lock will not fully engage, gently rock lock and extrusion back and forth while turning knob until lock fully opens.

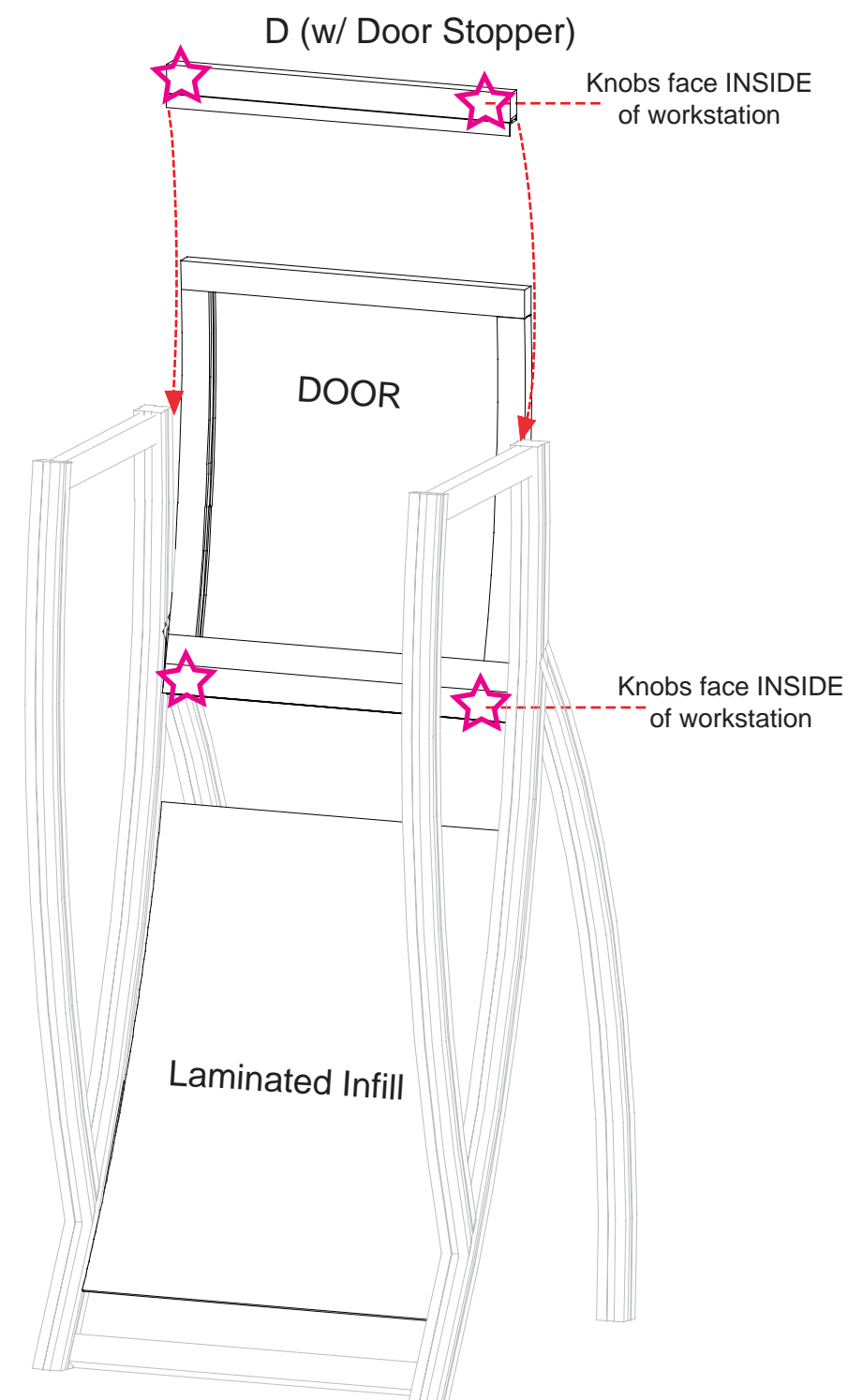
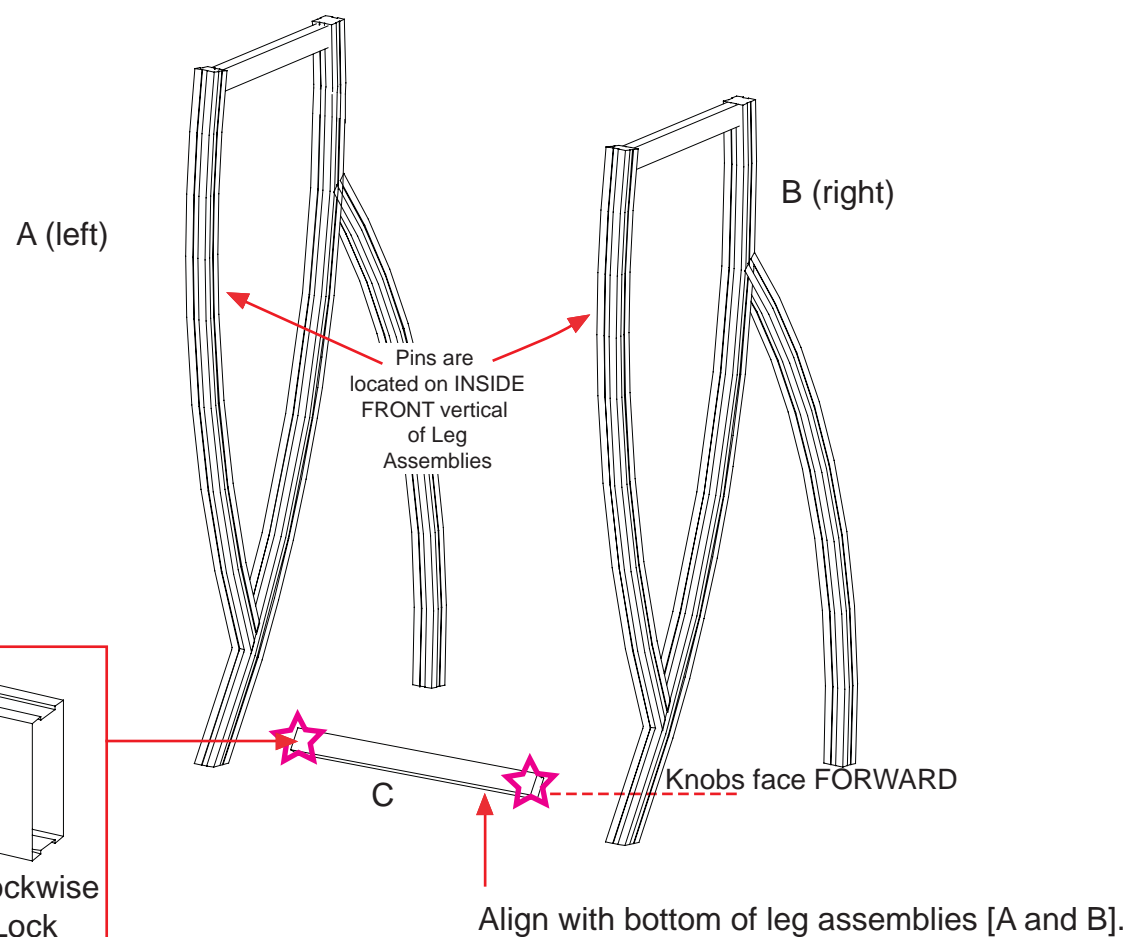

WHEN DISASSEMBLING TIGHTEN ALL KNOBS TO PREVENT LOSS DURING SHIPPING

| Part Number | Description |
|-------------|----------------------|
| E | Horizontal Extrusion |
| F | Horizontal Extrusion |

Step 2:

- A) Attach horizontal extrusion [E] between vertical leg assemblies [A and B] as shown below.
- B) Insert Laminated infill into grooves of vertical leg assemblies [A and B].
- C) Attach upper horizontal extrusion [F] between vertical leg assemblies [A and B] atop infill.
- D) Place internal shelf into assembled pedestal atop pins..
- E) Set Counter atop assembled pedestal and secure with Velcro straps attached to underside of top.

**Repeat Steps for 2nd Pedestal.

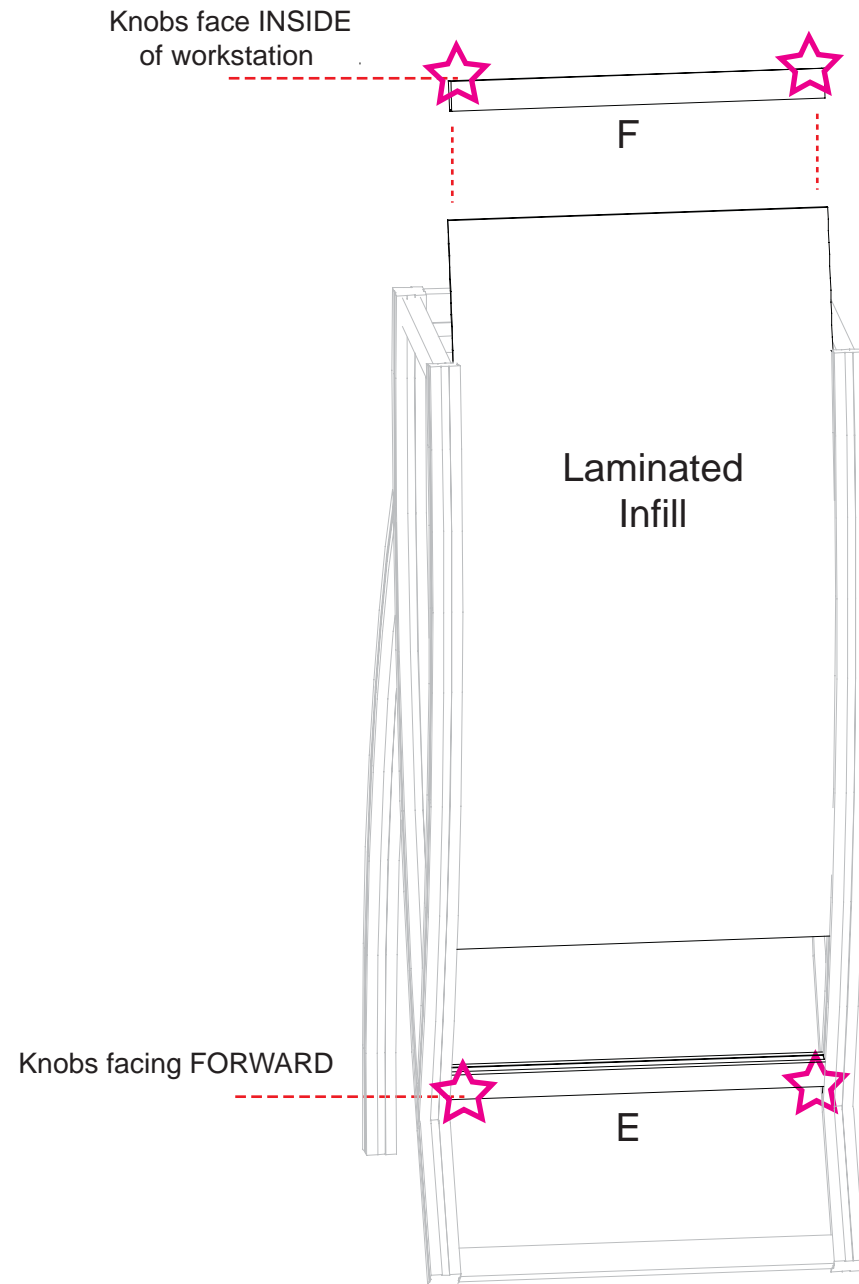

Place internal shelf into workstation then place counter atop assembled workstation.

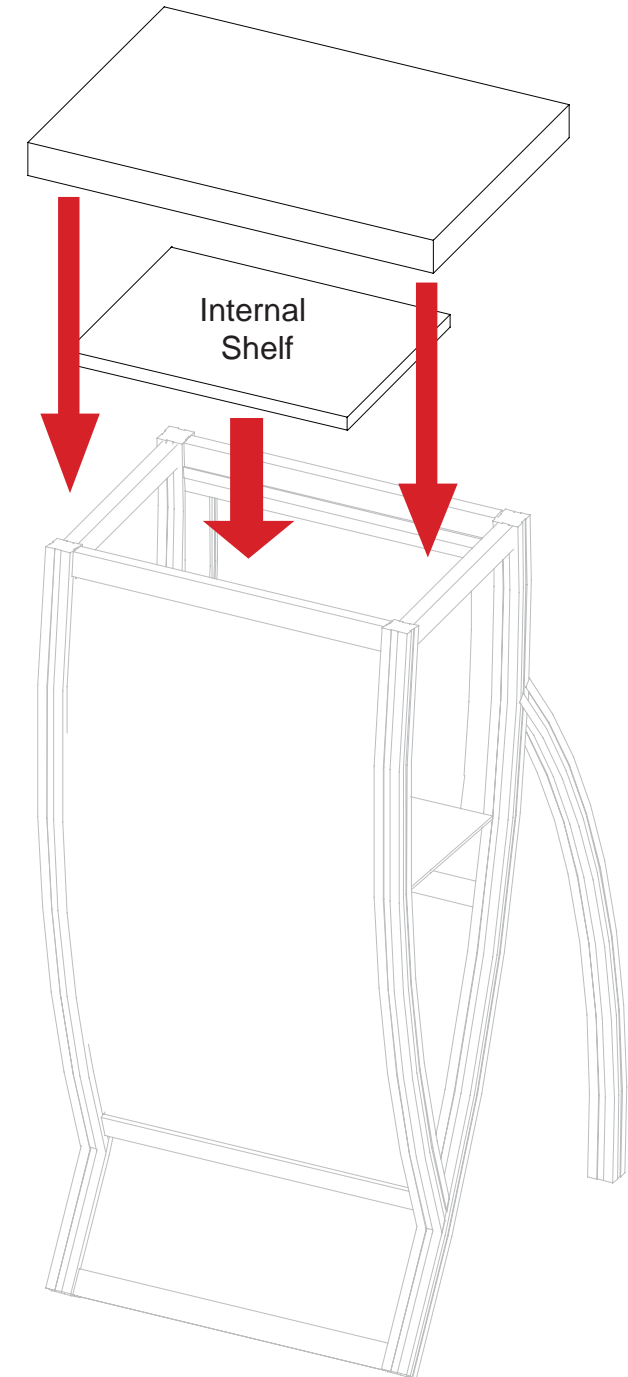

WHEN DISASSEMBLING TIGHTEN ALL KNOBS TO PREVENT LOSS DURING SHIPPING

Case #1 - Backwall Components

Top View of each Level

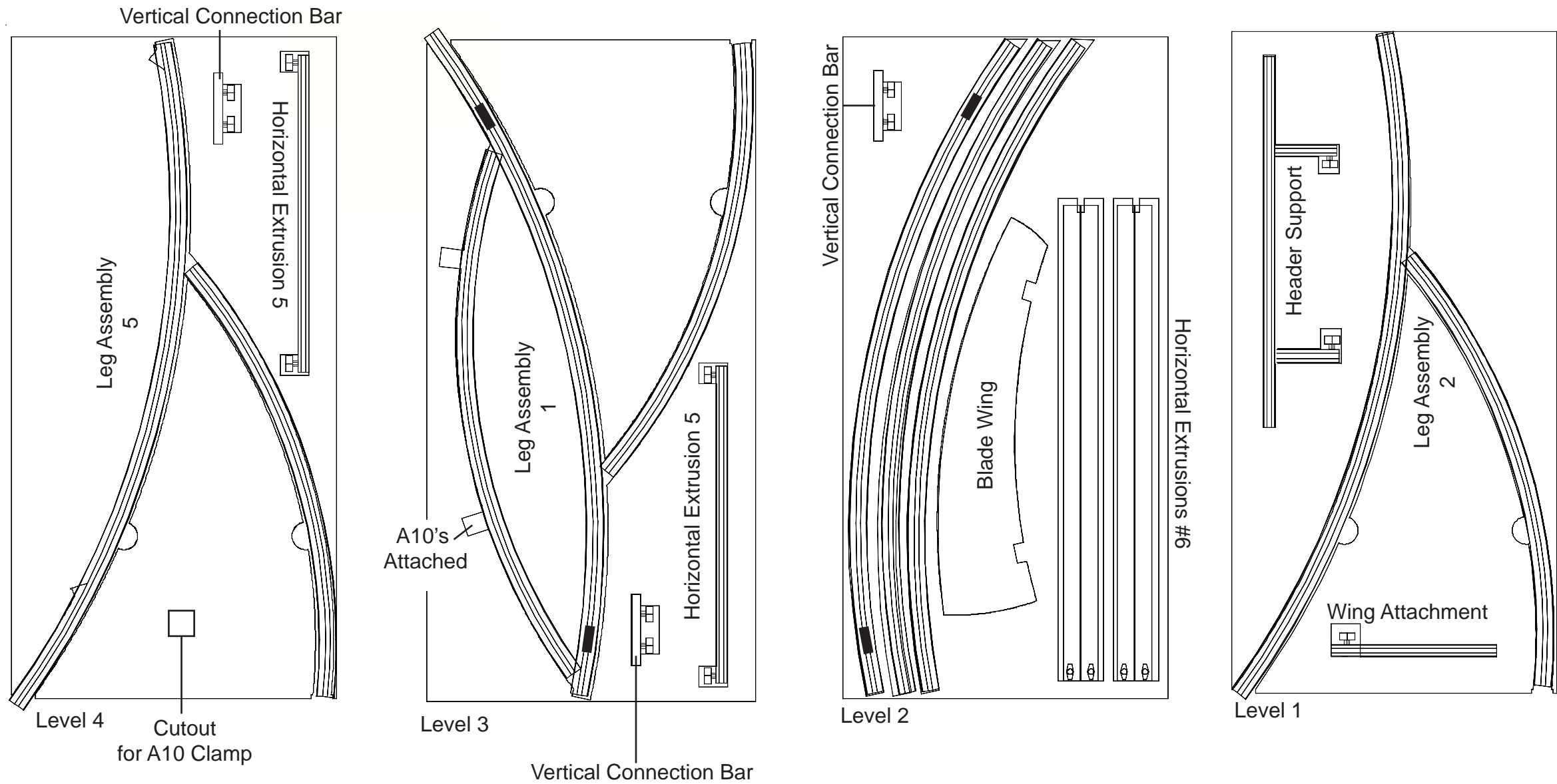

WHEN DISASSEMBLING TIGHTEN ALL KNOBS TO PREVENT LOSS DURING SHIPPING

Case #2 - Backwall Components

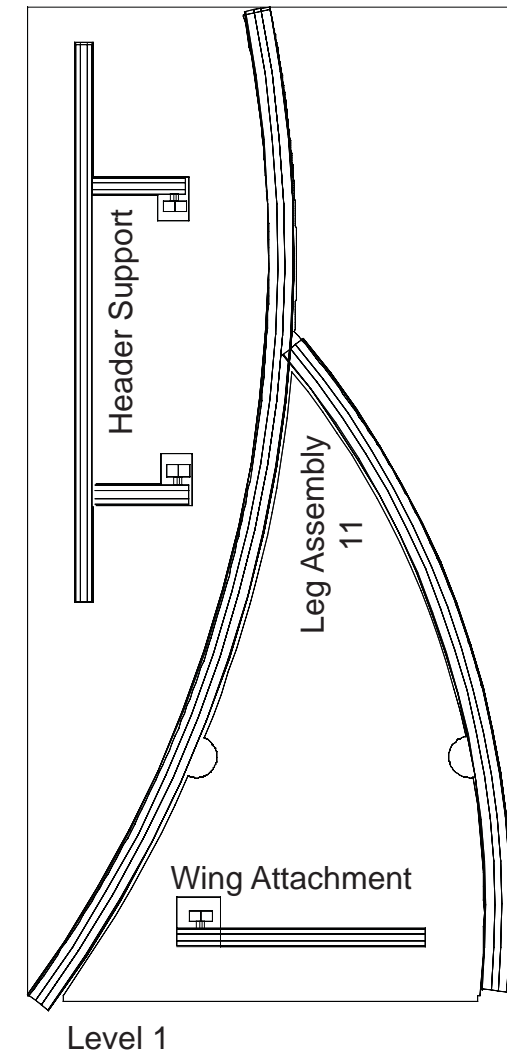
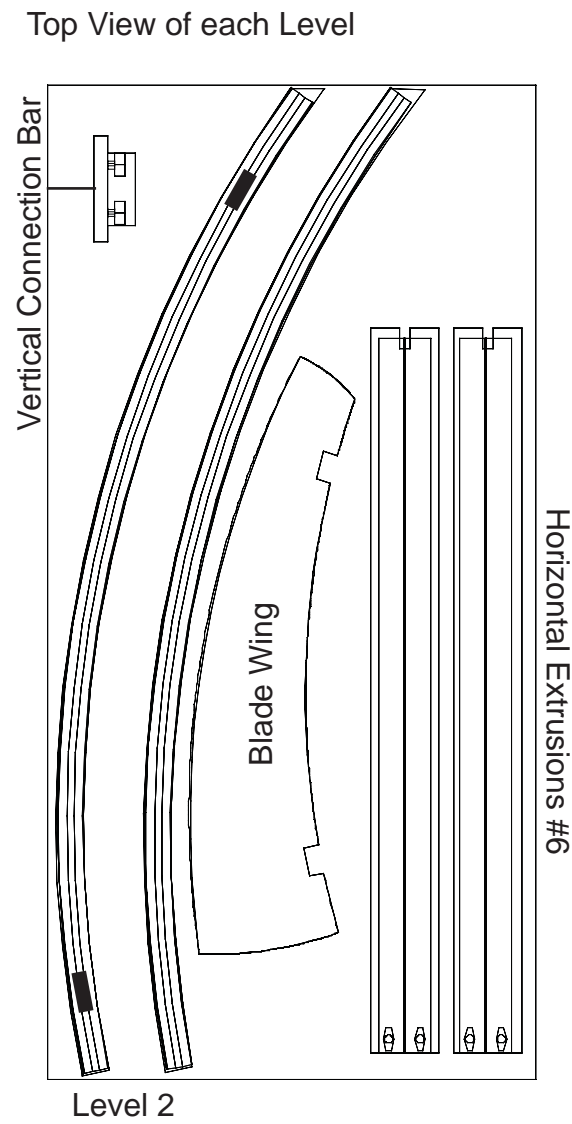
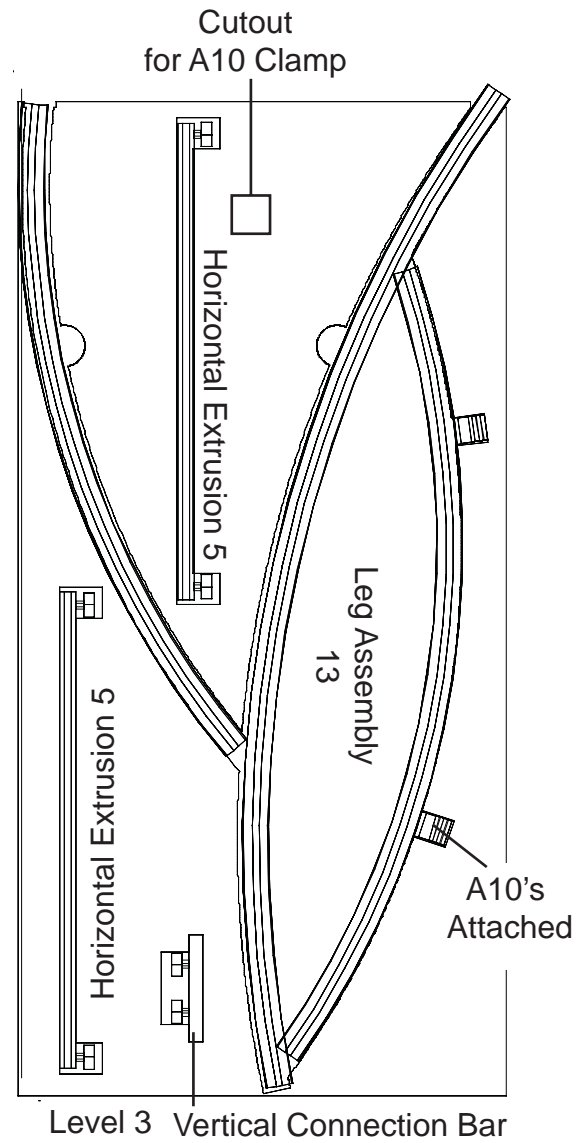

WHEN DISASSEMBLING TIGHTEN ALL KNOBS TO PREVENT LOSS DURING SHIPPING

Case #3 - Backwall Components

Top View of each Level

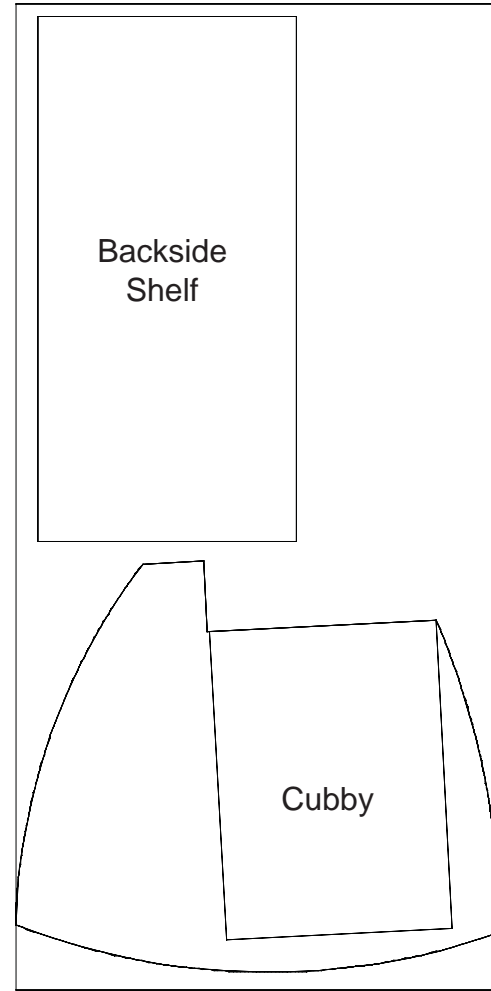

Level 2

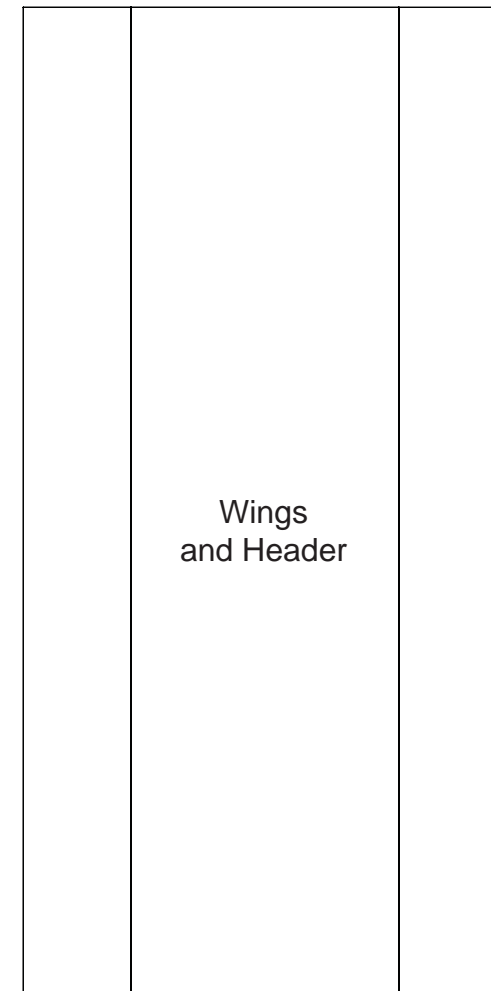

Level 1

WHEN DISASSEMBLING TIGHTEN ALL KNOBS TO PREVENT LOSS DURING SHIPPING

Case #4 - Backwall Components

Top View of each Level

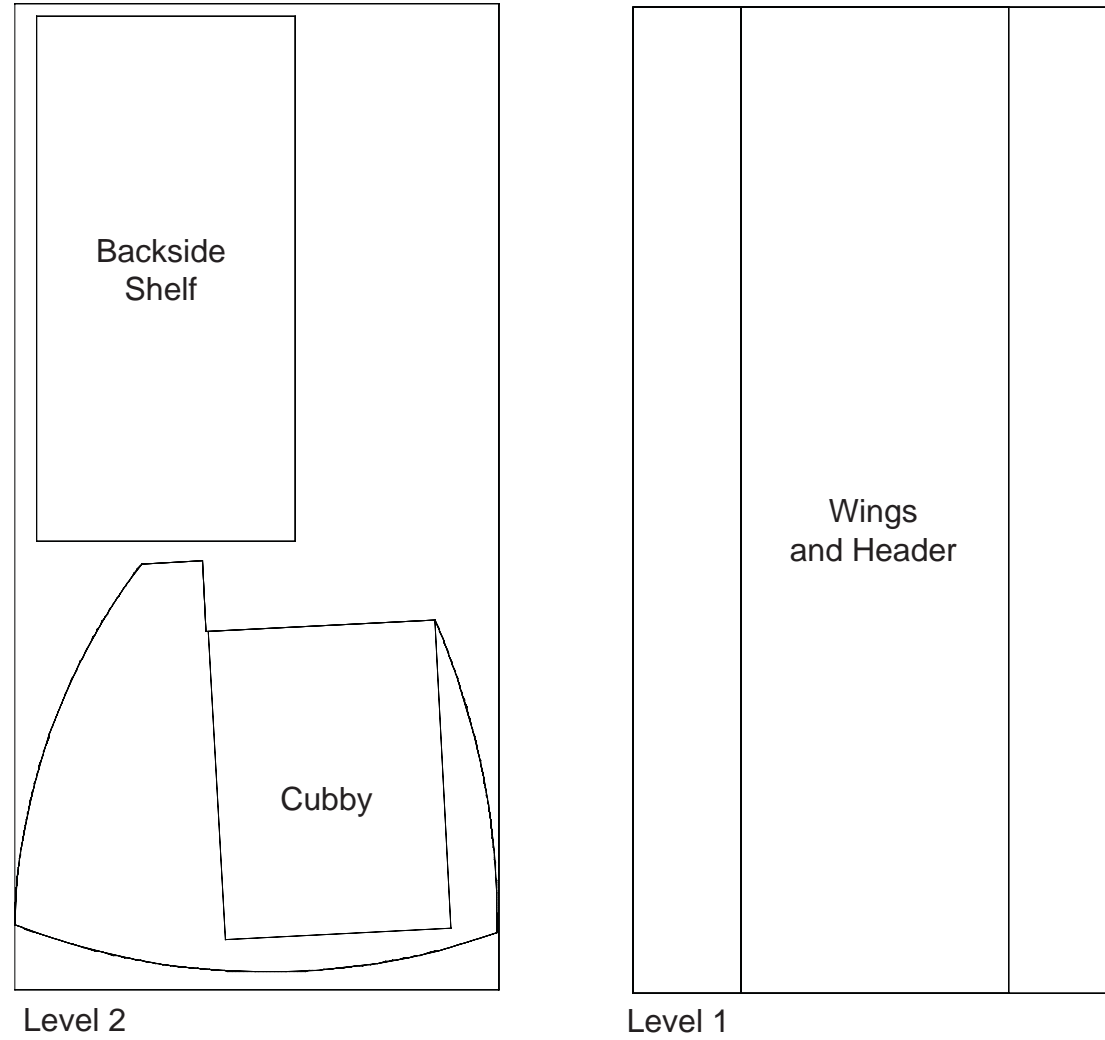

WHEN DISASSEMBLING TIGHTEN ALL KNOBS TO PREVENT LOSS DURING SHIPPING

Case #5 - Backwall Components

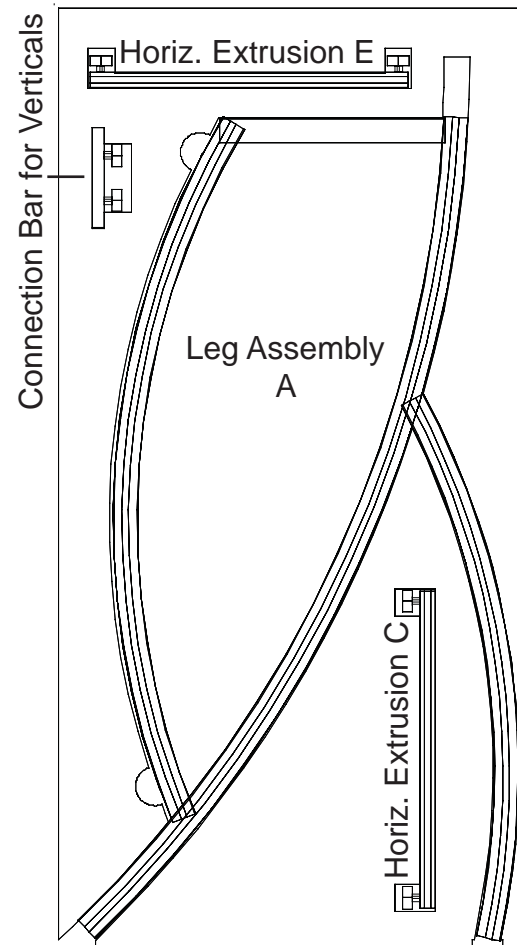

Level 5

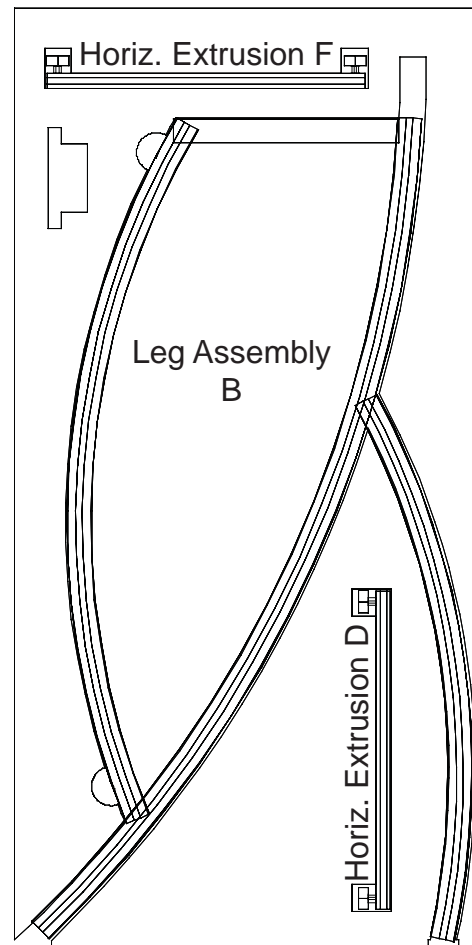

Level 4

Top View of each Level

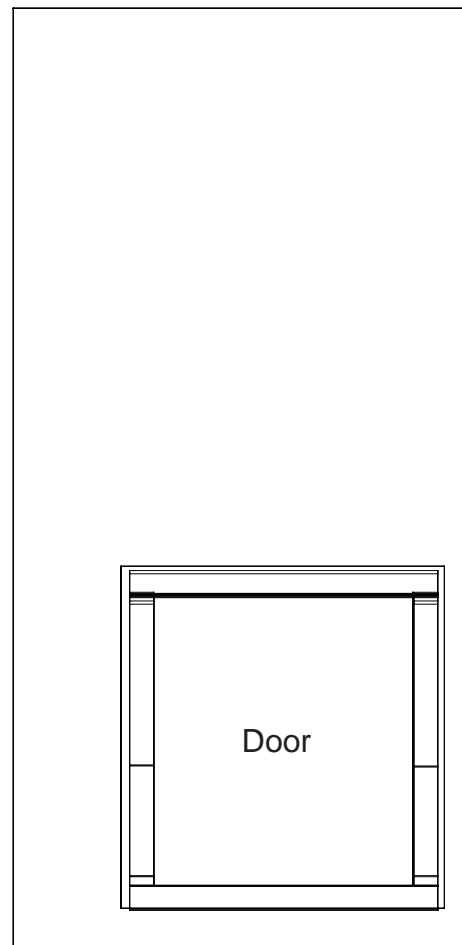

Level 3

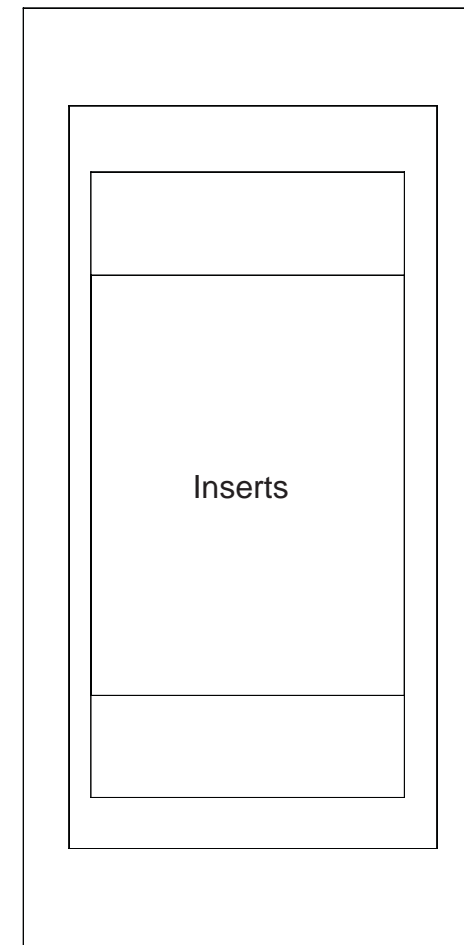

Level 2

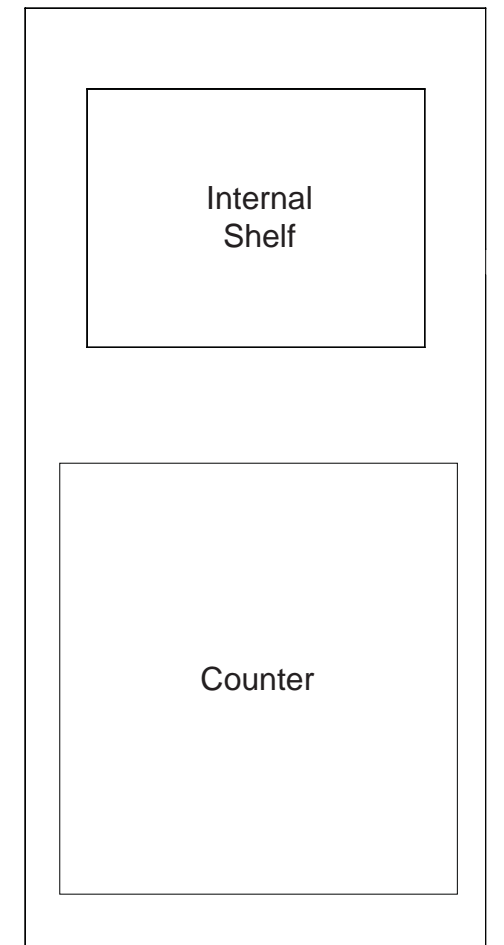

Level 1

WHEN DISASSEMBLING TIGHTEN ALL KNOBS TO PREVENT LOSS DURING SHIPPING

Case #6 - Backwall Components

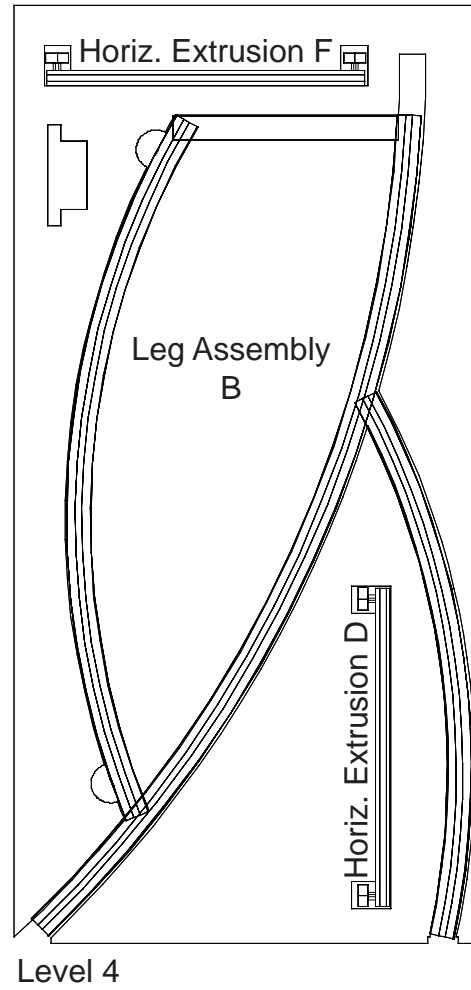
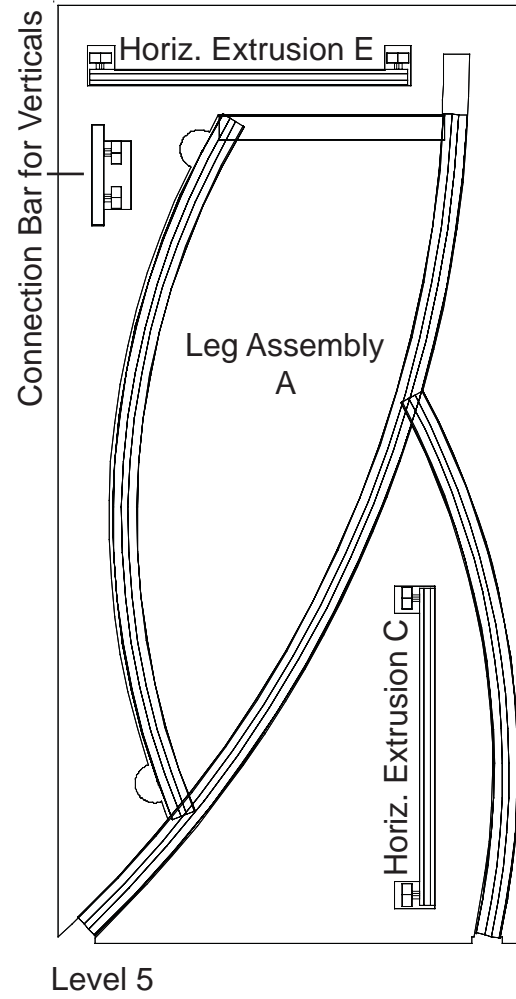

Top View of each Level

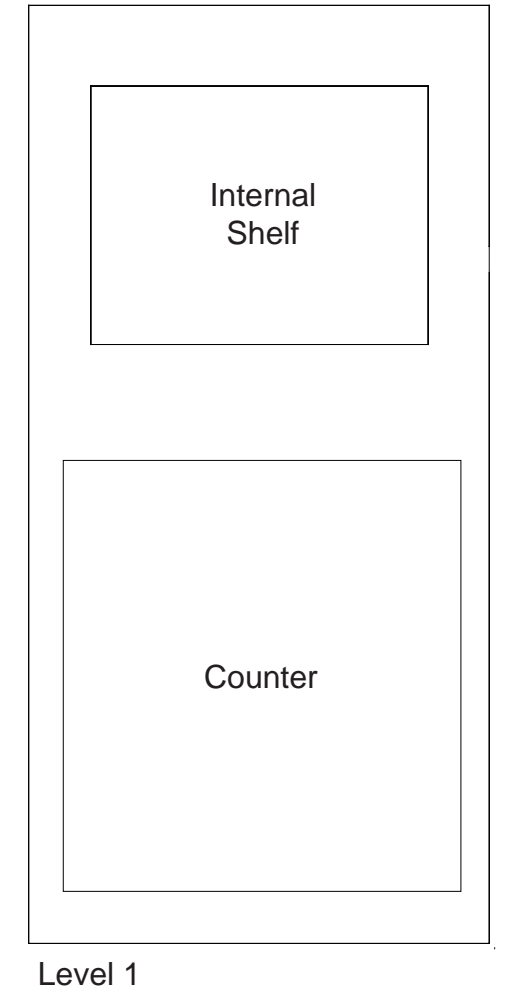
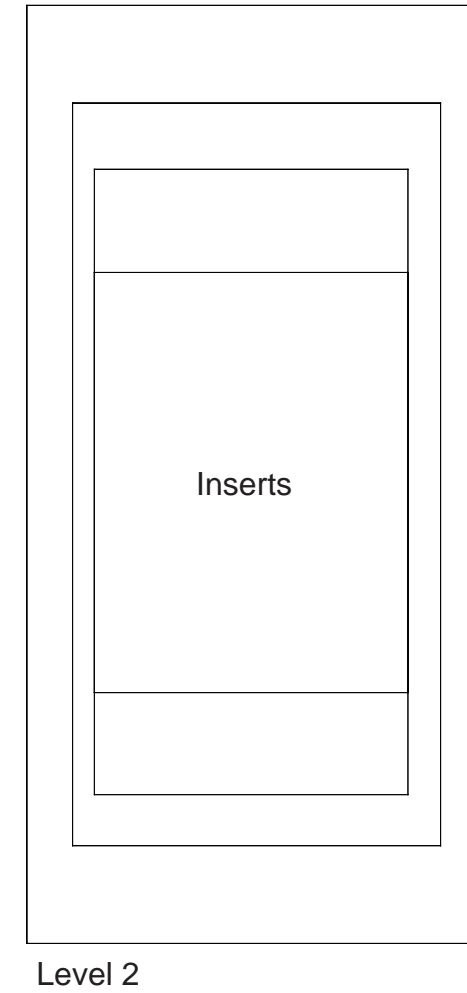
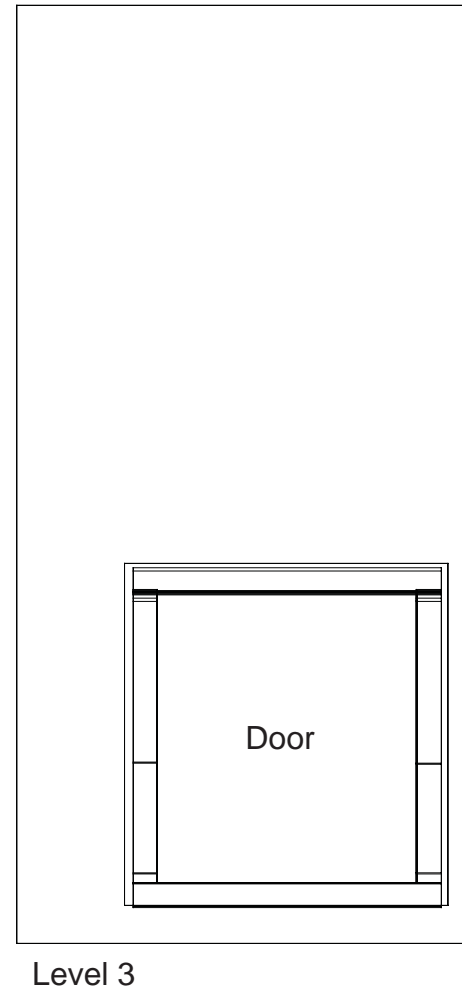

WHEN DISASSEMBLING TIGHTEN ALL KNOBS TO PREVENT LOSS DURING SHIPPING