

# euro It

Item Number	Description
1	9.5"r x 38"h Quarter Curve Panel
2	23"w x 38"h Flat Panel
3	9.5"r x 38"h Quarter Curve Panel
4	38"h 180° Connector
5	9.5"r x 38"h Quarter Curve Panel
6	23"w x 38"h Flat Panel w/ Door
7	9.5"r x 38"h Quarter Curve Panel
8	38"h 3-way T Connector
9	23"w x 38"h Flat Panel
10	9.5"r x 38"h Curve Panel
11	12.499"w x 38"h Curve Panel
12	9.5"r x 38"h Curve Panel
13	38"h Square End Cap
14	Vertical Shelf Supports w/ Velcro

**Steps**

- 1) Connect panel 1 to panel 2, and continue in numerical order [parts: 1 - 14].
- 2) Connect counter pieces together, then place atop assembled pedestal.

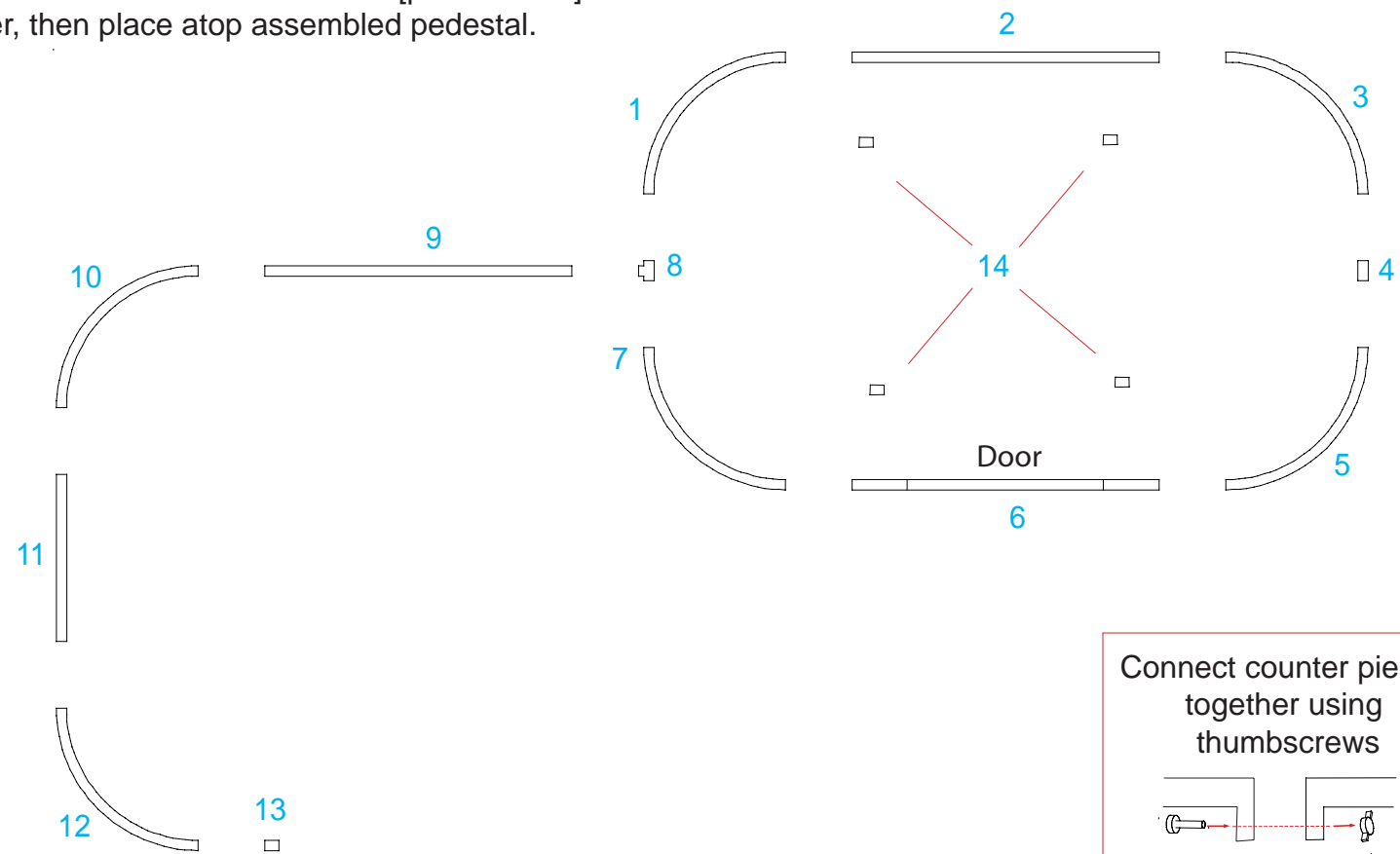

Connect counter pieces together using thumbscrews

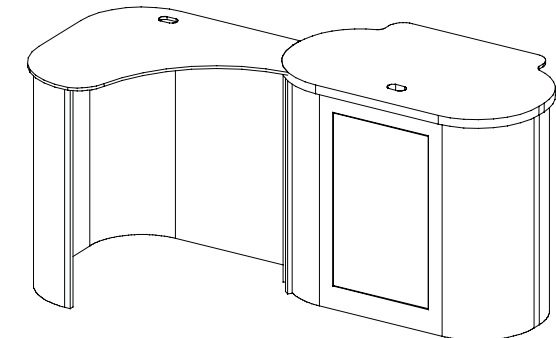

**Kiosk # 1**

Place shelf on vertical supports 14, then set assembled counter atop assembled pedestal.

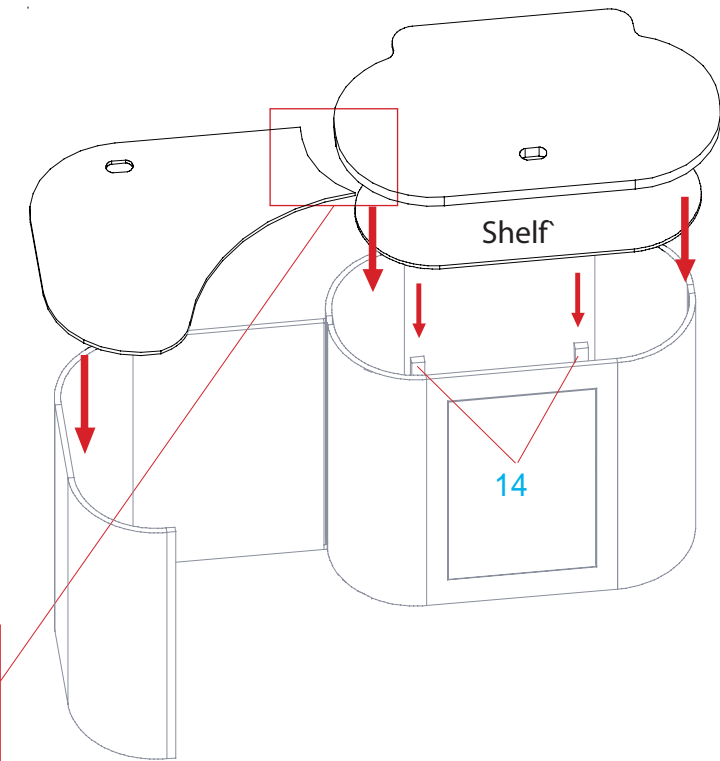

# euro It | HYBRIDS

## Euro LT Hybrids General Setup Instructions

### Using Your Setup Instructions

The Euro LT Hybrids Setup Instructions are created specifically for your configuration. They are laid out sequentially in levels, including exploded views, and a logical series of detailed steps to assemble the main structure and components. We encourage you to study the instructions **before** attempting to assemble your exhibit.

### Cleaning and Packing Your Display

- 1) When cleaning laminate countertops or panels use mild cleansers and a soft material such as cotton.
- 2) Keep all display components away from extreme heat and long exposure to sunlight to avoid warping and fading.
- 3) Retain all packing material. It will make re-packing much easier and will reduce the likelihood of shipping damage.

Level 1 = Blue  
 Level 2 = Red  
 Level 3 = Green  
 Level 4 = Black

#### Color Code

The top clip is color coded to distinguish the level. The color coded clip also contains the numbered label

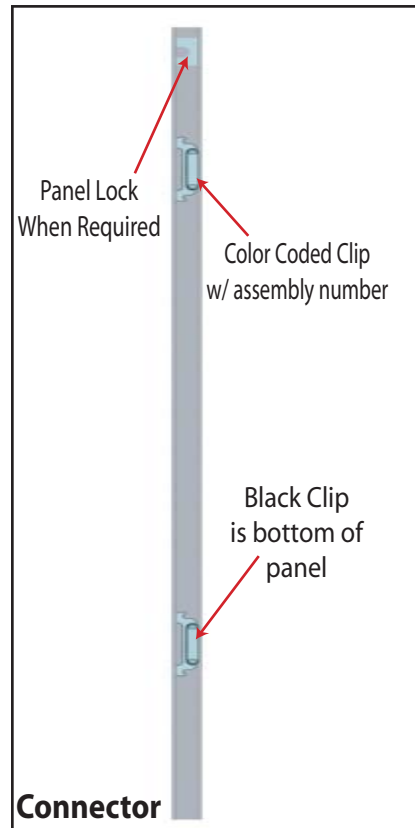

Each component has 2 clips, the lower clip is ALWAYS black..

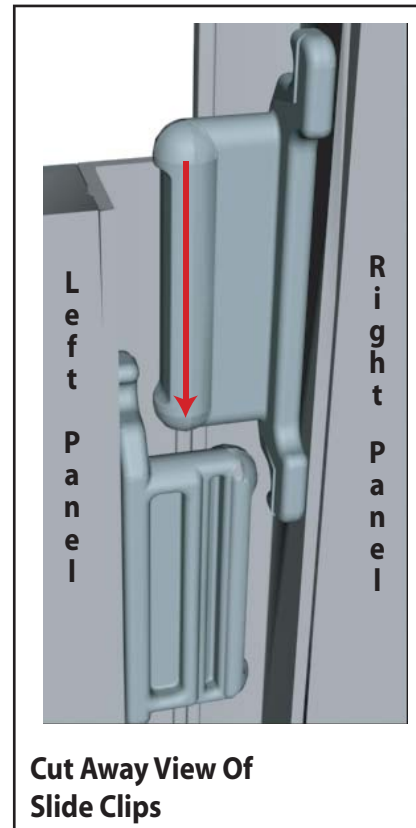

Components connect together by aligning them and sliding downward connecting clips together.

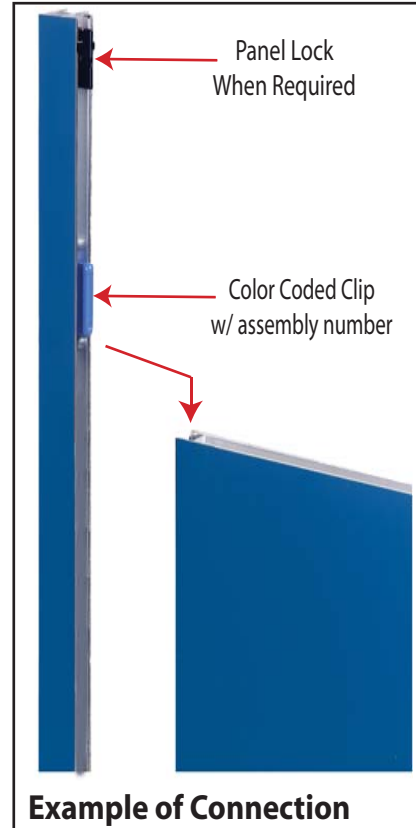

Configurations are assembled from left to right, usually starting with #1 and following the numbered sequence.

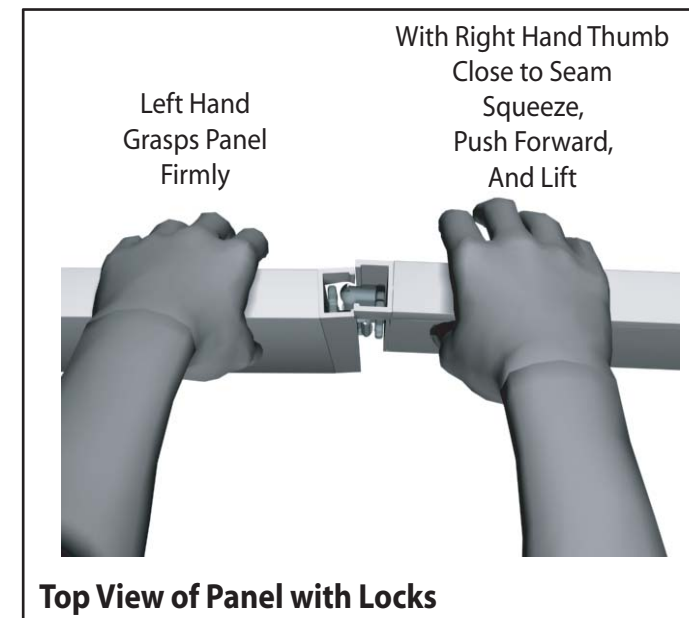

The first level of components contains panel locks that are located at the top of the panel for extra stability and a seamless connection. When disassembling panels, twist top connection slightly and lift right panel upward.

