

Perfect 10 Hybrid Displays

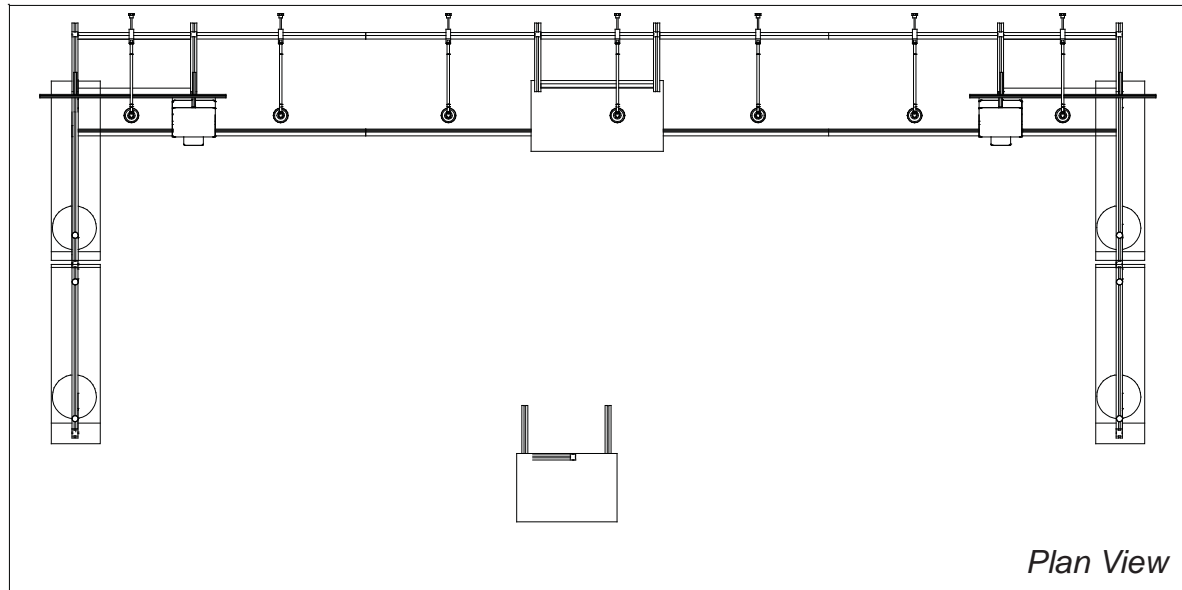

20'

10'

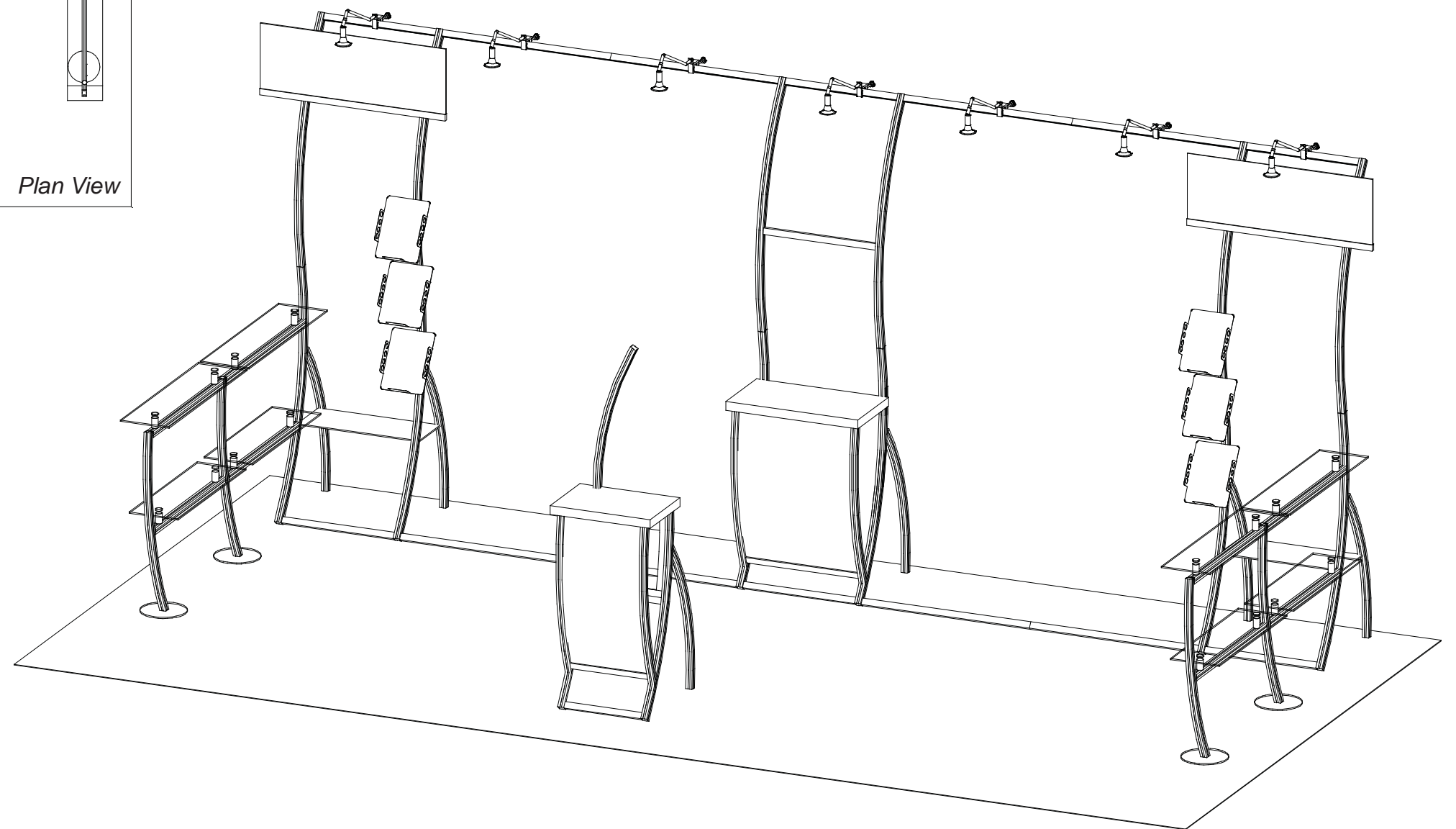

WHEN DISASSEMBLING TIGHTEN ALL KNOBS TO PREVENT LOSS DURING SHIPPING

Part Number	Description
1	Left Leg Assembly w/ A10 Clamps Attached
2	Middle Leg Assembly
3A	Upper Curved Vertical w/ A10 Clamps Attached
3	Upper Curved Vertical
4	23" w Horizontal



Step 1:

NOTE: Can be assembled either face down on floor then lifted upright or upright as shown in drawings.

- A) Connect vertical leg assemblies [1 and 2] together by connecting horizontal extrusions [4] between assemblies tightening BLACK knobs on backside of extrusion making sure Velcro faces toward BACK and placing it about one inch up from bottom and tightening.
- B) Connect vertical extrusions [3 and 3A] to leg assemblies [1 and 2] using vertical connection bar as shown.
- C) Connect upper horizontal extrusion [4] between verticals [3 and 3A] placing it about one inch down from top.

NOTE: Make sure the lock is flush with extrusion before tightening. If lock will not fully engage, gently rock lock and extrusion while turning knob until lock fully opens.

Rear View of Display

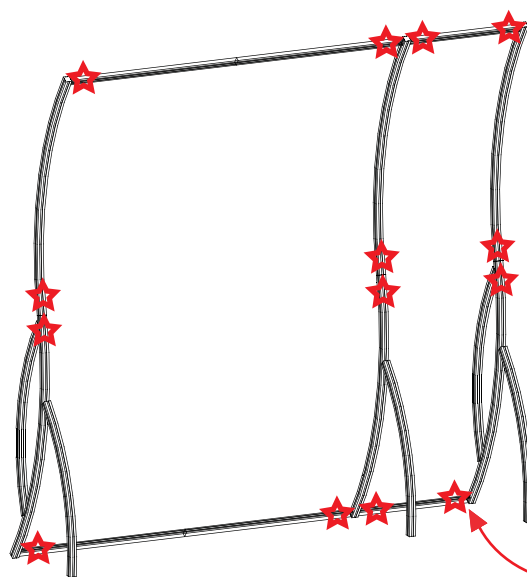

STAR indicates location of knobs on BACKSIDE of unit.

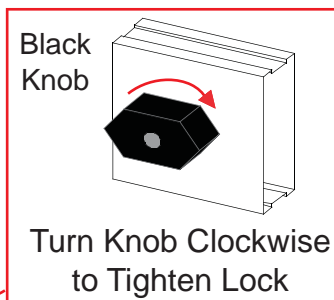

Step 1

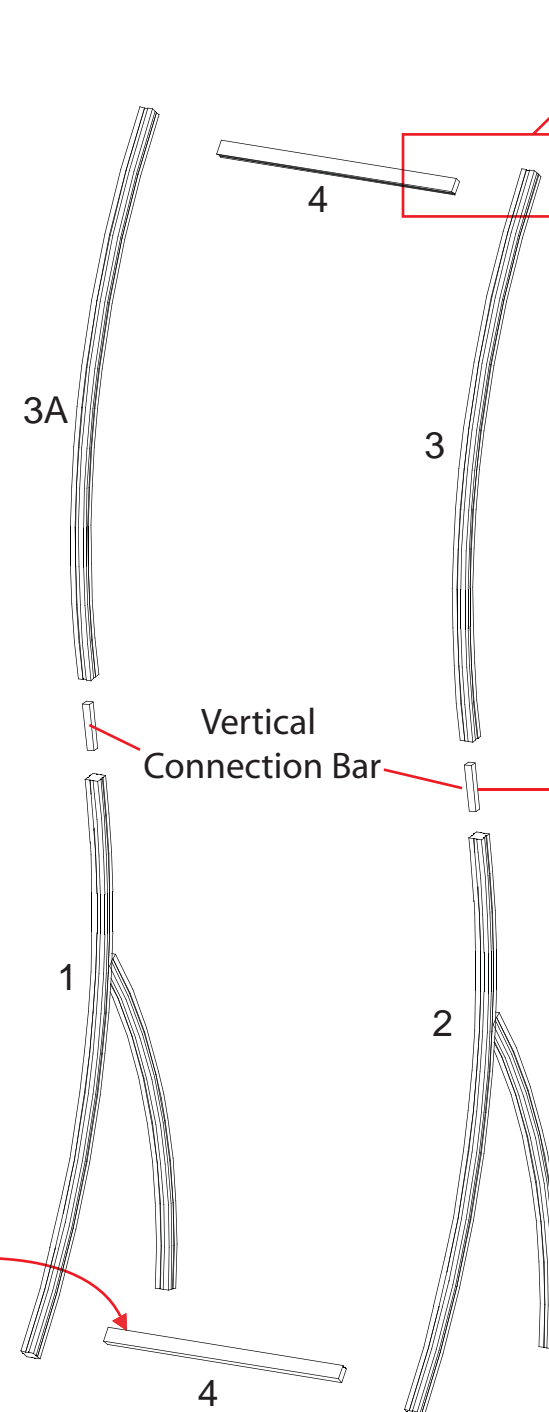

NOTE: When assembling horizontals they should be placed approximately one inch from TOP and BOTTOM.

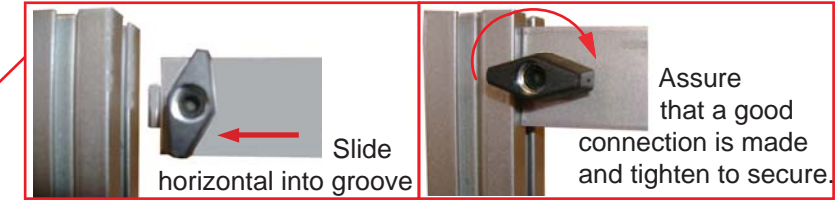

Slide Connection Bar into lower leg assembly. Slide upper vertical over bar and secure both.

Step stool may be required for assembly.



WHEN DISASSEMBLING TIGHTEN ALL KNOBS TO PREVENT LOSS DURING SHIPPING

866.652.2100

Part Number	Description
5	Leg Assembly
5A	Extrusion Assembly
6	Upper Curved Vertical
7	69" w Horizontal w/ Hinge Facing UP
8	69" w Horizontal w/ Hinge Facing DOWN

NOTE: When assembling horizontals they should be placed approximately one inch from TOP and BOTTOM.

Step 2

Step 2:

NOTE: Can be assembled either face down on floor then lifted upright or upright as shown in drawings.

- A) Connect extrusion assembly [5A] to leg assembly [5], placing insert as shown.
- B) Connect vertical extrusion [6] to leg assembly [5] using vertical connection bar as shown.
- C) Connect horizontal extrusions [7 and 8] between vertical assemblies by tightening BLACK knobs on backside of extrusion making sure Velcro faces toward BACK.

NOTE: Make sure the lock is flush with extrusion before tightening. If lock will not fully engage, gently rock lock and extrusion while turning knob until lock fully opens.

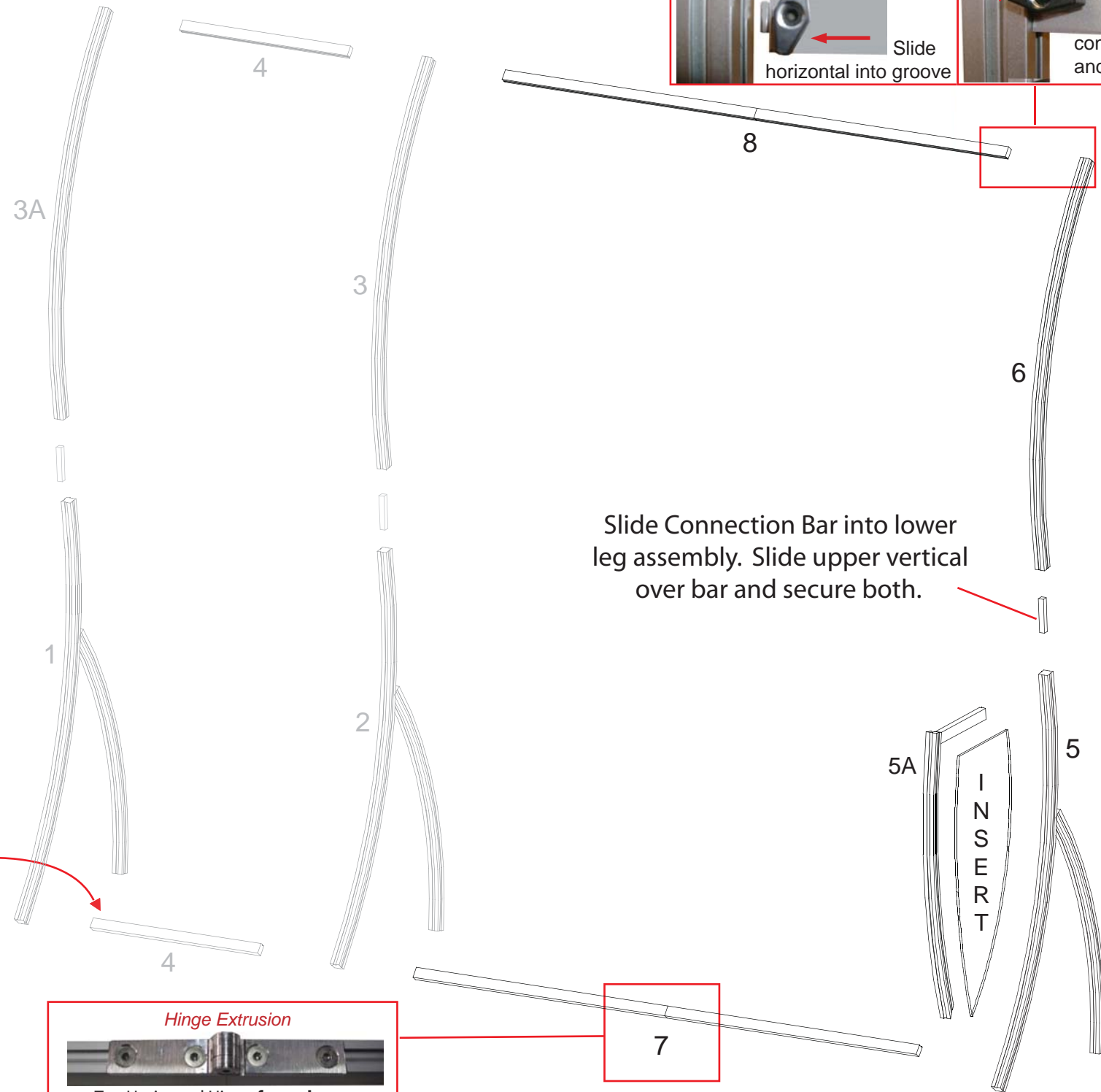
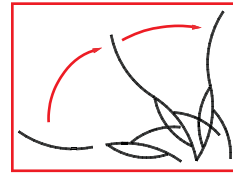

Slide Connection Bar into lower leg assembly. Slide upper vertical over bar and secure both.

Rear View of Display

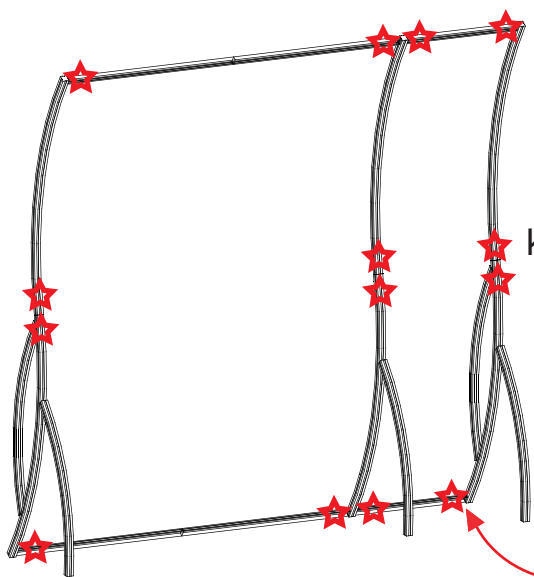

STAR indicates location of knobs on BACKSIDE of unit.

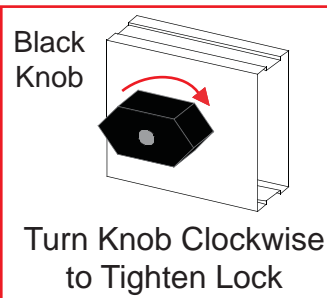

WHEN DISASSEMBLING TIGHTEN ALL KNOBS TO PREVENT LOSS DURING SHIPPING

866.652.2100

Part Number	Description
9	Leg Assembly
9A	Extrusion Assembly
10	Upper Curved Vertical
11	23" w Horizontal
12	23" w Horizontal for Monitor Mount Attachment
13	23" w Horizontal

Step 3

NOTE: When assembling horizontals they should be placed approximately one inch from TOP and BOTTOM.

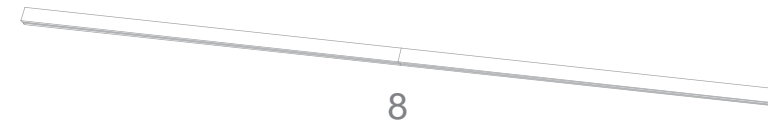

Step 3:

NOTE: Can be assembled either face down on floor then lifted upright or upright as shown in drawings.

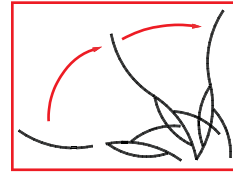

- A) Connect extrusion assembly [9A] to leg assembly [9], placing insert as shown.
- B) Connect vertical extrusion [10] to leg assembly [9] using vertical connection bar as shown.
- C) Connect horizontal extrusions [11, 12 and 13] between vertical assemblies making sure Velcro faces toward BACK.

NOTE: Make sure the lock is flush with extrusion before tightening. If lock will not fully engage, gently rock lock and extrusion while turning knob until lock fully opens.

Rear View of Display

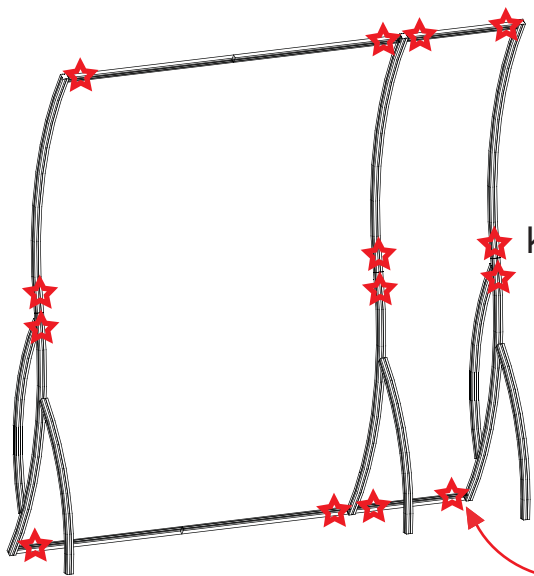

STAR indicates location of knobs on BACKSIDE of unit.

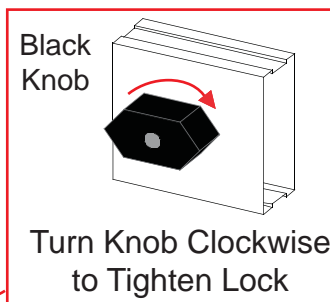

Black Knob

Turn Knob Clockwise to Tighten Lock

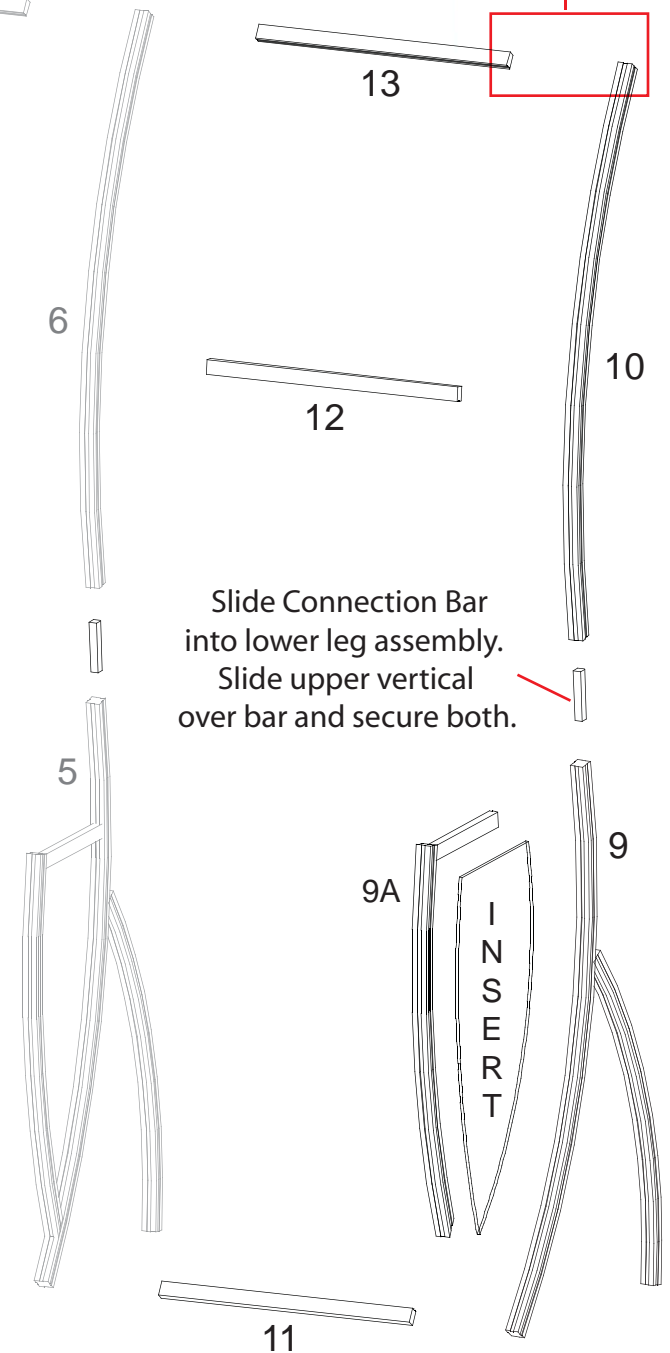

WHEN DISASSEMBLING TIGHTEN ALL KNOBS TO PREVENT LOSS DURING SHIPPING

Part Number	Description
14	23" w Horizontal

Step 4



Step 4:

NOTE: Can be assembled either face down on floor then lifted upright or upright as shown in drawings.

- A) Insert laminated infill into grooves of vertical leg assemblies [5 and 9].
- B) Attach horizontal extrusion [14] between vertical leg assemblies [5 and 9] atop infill.
- C) Set counter top atop assembled workstation and secure with Velcro straps attached to underside of top.

NOTE: Make sure the lock is flush with extrusion before tightening. If lock will not fully engage, gently rock lock and extrusion while turning knob until lock fully opens.

STAR indicates location of knobs on BACKSIDE of unit.

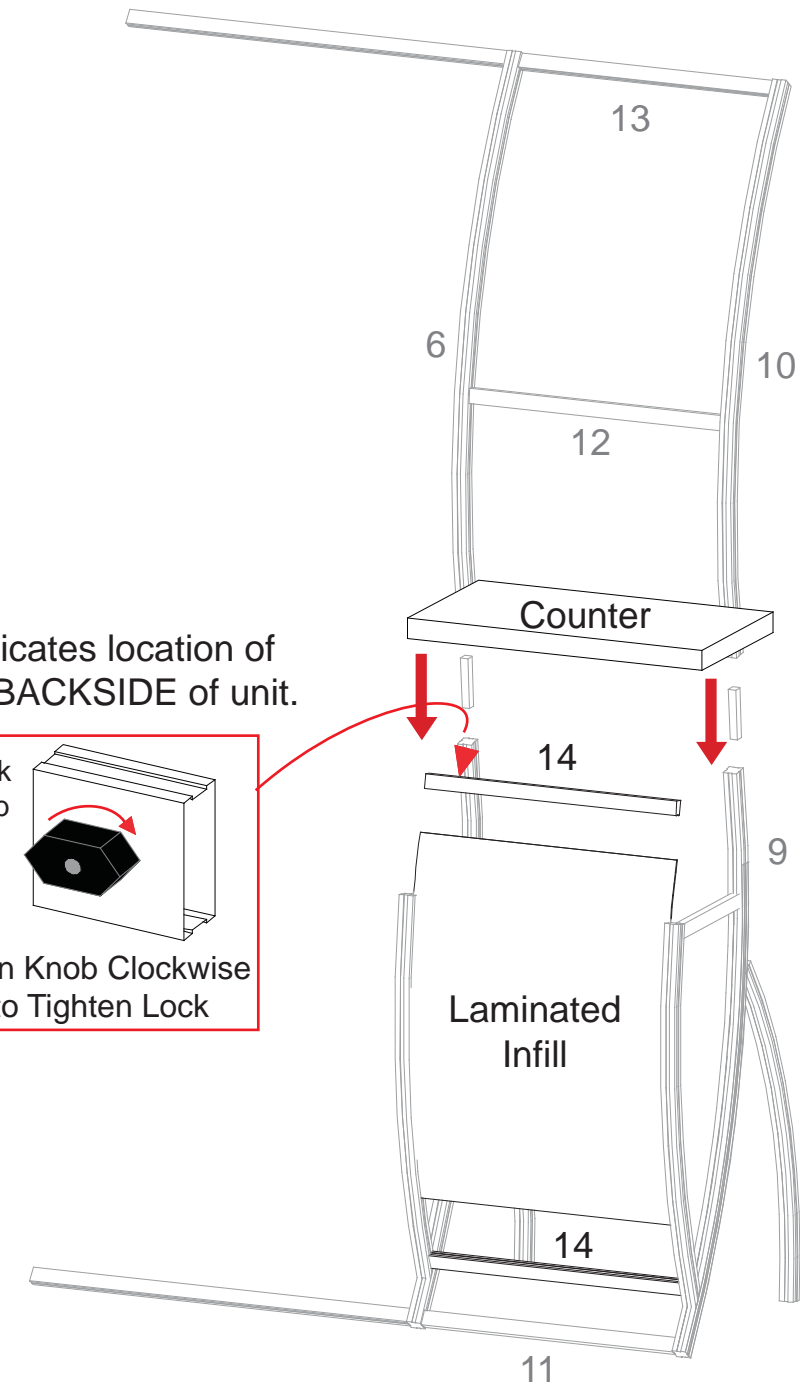
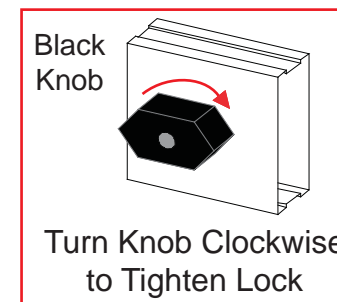

WHEN DISASSEMBLING TIGHTEN ALL KNOBS TO PREVENT LOSS DURING SHIPPING

866.652.2100

Part Number	Description
15	Leg Assembly
16	Upper Curved Vertical
17	69" w Horizontal w/ Hinge Facing UP
18	69" w Horizontal w/ Hinge Facing DOWN

Step 5

NOTE: When assembling horizontals they should be placed approximately one inch from TOP and BOTTOM.

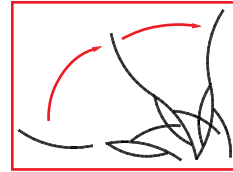

Step 4:

NOTE: Can be assembled either face down on floor then lifted upright or upright as shown in drawings.

- A) Connect vertical extrusion [16] to leg assembly [15] using vertical connection bar as shown
- B) Connect horizontal extrusions [17 and 18] between vertical assemblies by tightening BLACK knobs on backside of extrusion making sure Velcro faces toward BACK.

NOTE: Make sure the lock is flush with extrusion before tightening. If lock will not fully engage, gently rock lock and extrusion while turning knob until lock fully opens.

STAR indicates location of knobs on BACKSIDE of unit.

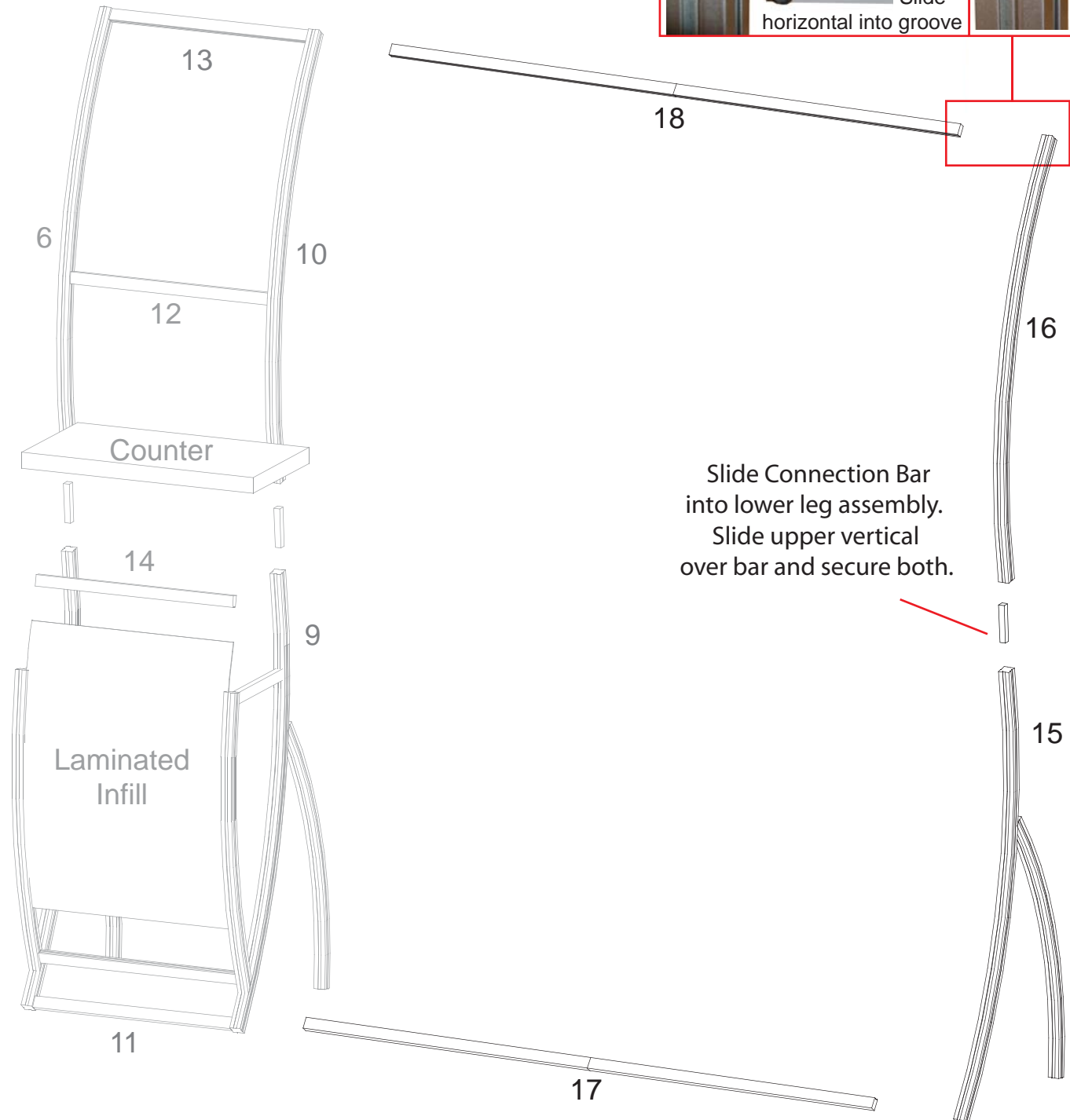
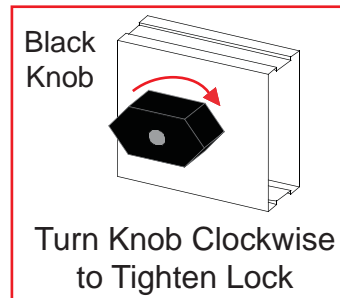

WHEN DISASSEMBLING TIGHTEN ALL KNOBS TO PREVENT LOSS DURING SHIPPING

866.652.2100

Part Number	Description
19	Leg Assembly
20	Upper Curved Vertical
21	23" w Horizontal
22	23" w Horizontal

NOTE: When assembling horizontals they should be placed approximately one inch from TOP and BOTTOM.

Step 6

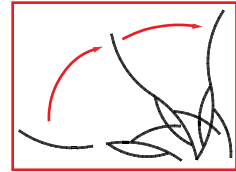
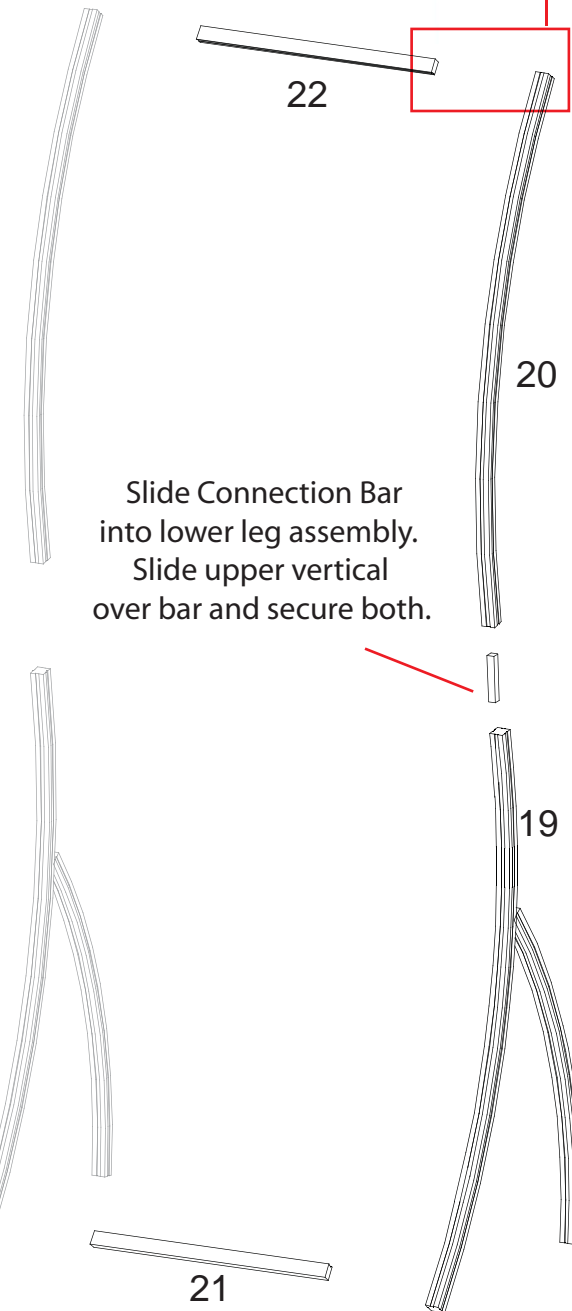
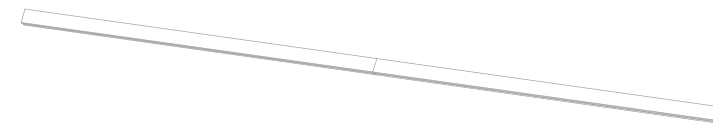
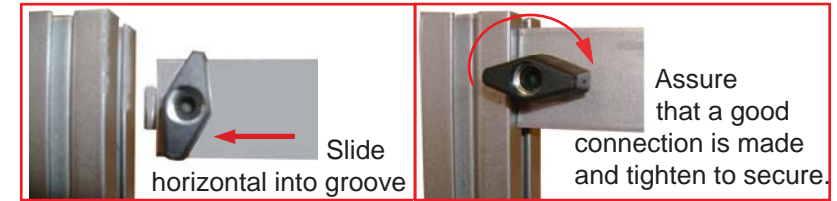

Step 5:
 NOTE: Can be assembled either face down on floor then lifted upright or upright as shown in drawings.
 A) Connect vertical extrusion [16] to leg assembly [15] using vertical connection bar as shown.
 B) Connect horizontal extrusions [17 and 18] between vertical assemblies by tightening BLACK knobs on backside of extrusion making sure Velcro faces toward BACK.

NOTE: Make sure the lock is flush with extrusion before tightening. If lock will not fully engage, gently rock lock and extrusion while turning knob until lock fully opens.

Rear View of Display

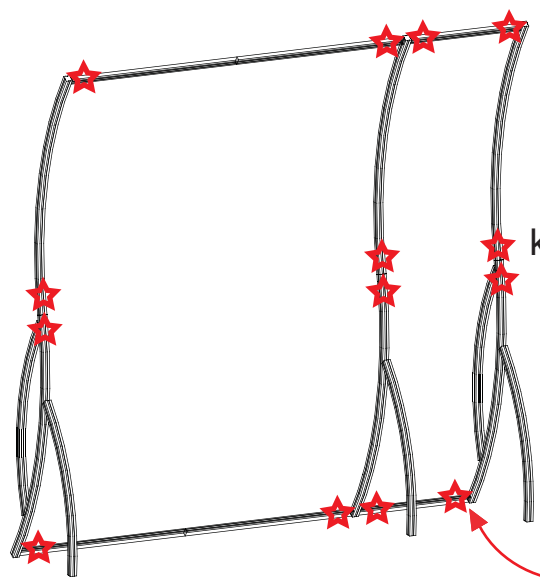

STAR indicates location of knobs on BACKSIDE of unit.

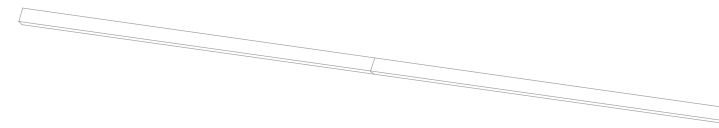
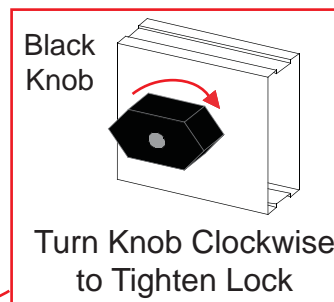

WHEN DISASSEMBLING TIGHTEN ALL KNOBS TO PREVENT LOSS DURING SHIPPING

866.652.2100

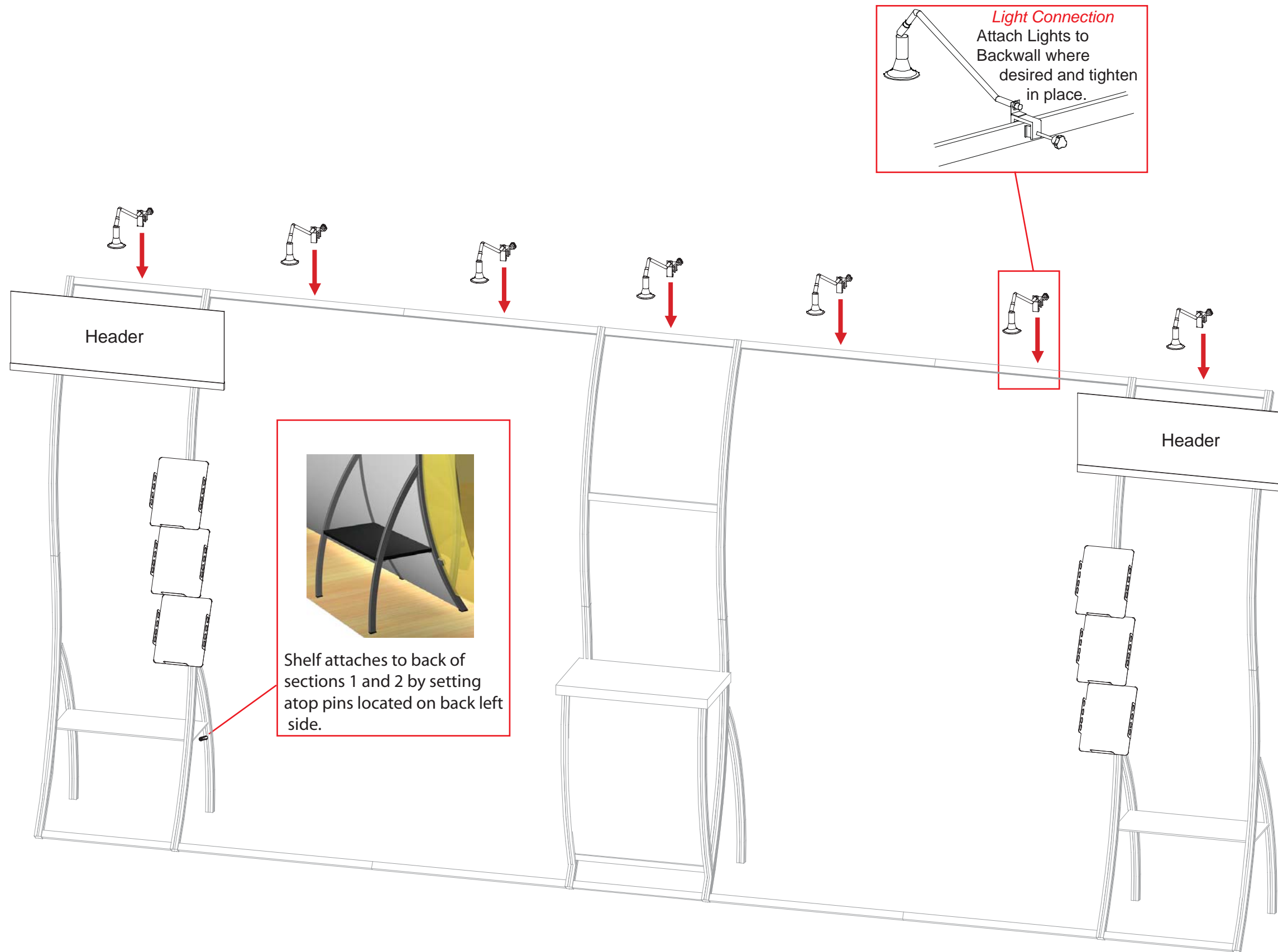

Light Connection
Attach Lights to Backwall where desired and tighten in place.

Accessory Attachment
Attach Header support then Slide header into Groove

Shelf attaches to back of sections 1 and 2 by setting atop pins located on back left side.

Literature Rack Attachment

Tighten Lock to Secure

Attach connector piece to rack as shown. Then connect assembled literature rack to vertical extrusion.

WHEN DISASSEMBLING TIGHTEN ALL KNOBS TO PREVENT LOSS DURING SHIPPING

Part Number	Description
23	Base Plate
24	Curved Vertical
25	32.95" w Horizontal
26	33" w Horizontal
27	32.826" w Horizontal
28	38" w Horizontal
29	32.95" w Horizontal
30	33" w Horizontal
31	32.826" w Horizontal
32	38" w Horizontal

Step 7:

- A) Attach curved verticals [24] to base plates [23], see Base Plate Attachment detail below.
- B) Attach horizontals [25, 26, 27, 28, 29, 30, 31 and 32] between vertical assemblies.
- C) Attach shelves to horizontals using standoff barrels and screw caps.

NOTE: Make sure the lock is flush with extrusion before tightening. If lock will not fully engage, gently rock lock and extrusion while turning knob until lock fully opens.

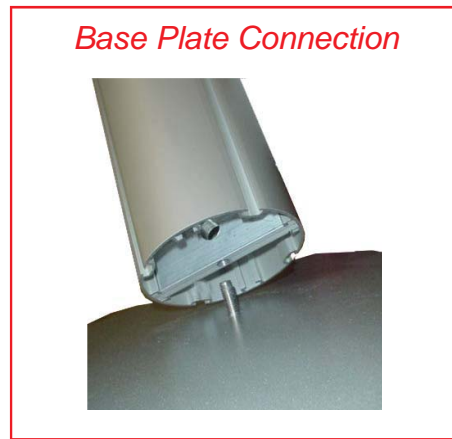

Attach base plate to round or square vertical extrusion using the bolt provided. Be careful not to strip the threads.

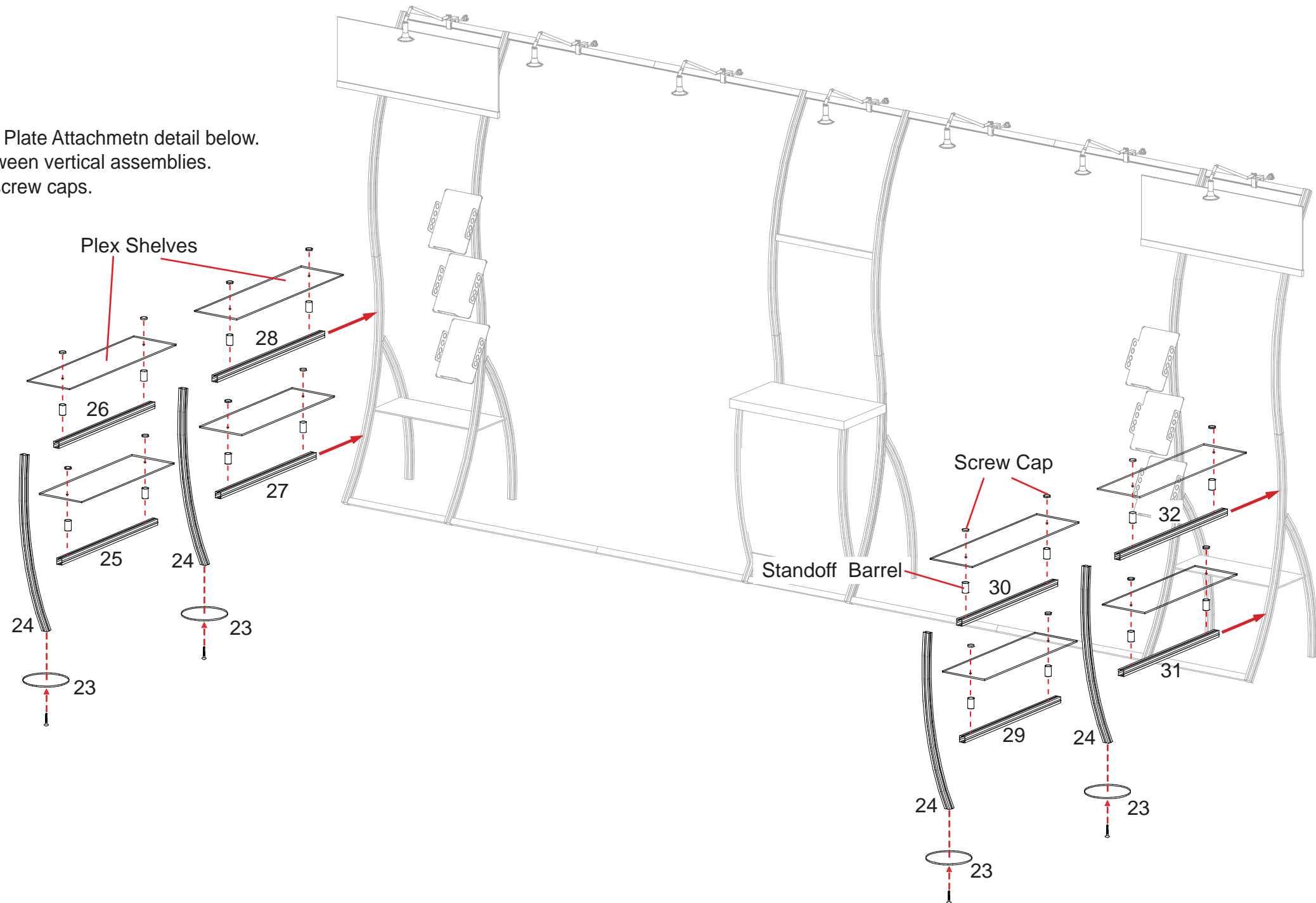

WHEN DISASSEMBLING TIGHTEN ALL KNOBS TO PREVENT LOSS DURING SHIPPING

Part Number	Description
A	Left Leg Assembly
B	Right Leg Assembly
C	Horizontal Extrusion
D	Horizontal Extrusion w/ Door Stopper

Step 1:

- A) Connect lower horizontal extrusion [C] between bottom of leg assemblies [A and B] as shown.
- B) Insert Laminated infill into grooves of leg assemblies [A and B].
- C) Attach extrusion door between leg assemblies [A and B] and atop laminated infill.
- D) Attach upper horizontal extrusion w/ door stopper [D] between leg assemblies [A and B], and set flush with top of legs [A and B].

NOTE: Make sure the lock is flush with extrusion before tightening. If lock will not fully engage, gently rock lock and extrusion back and forth while turning knob until lock fully opens.

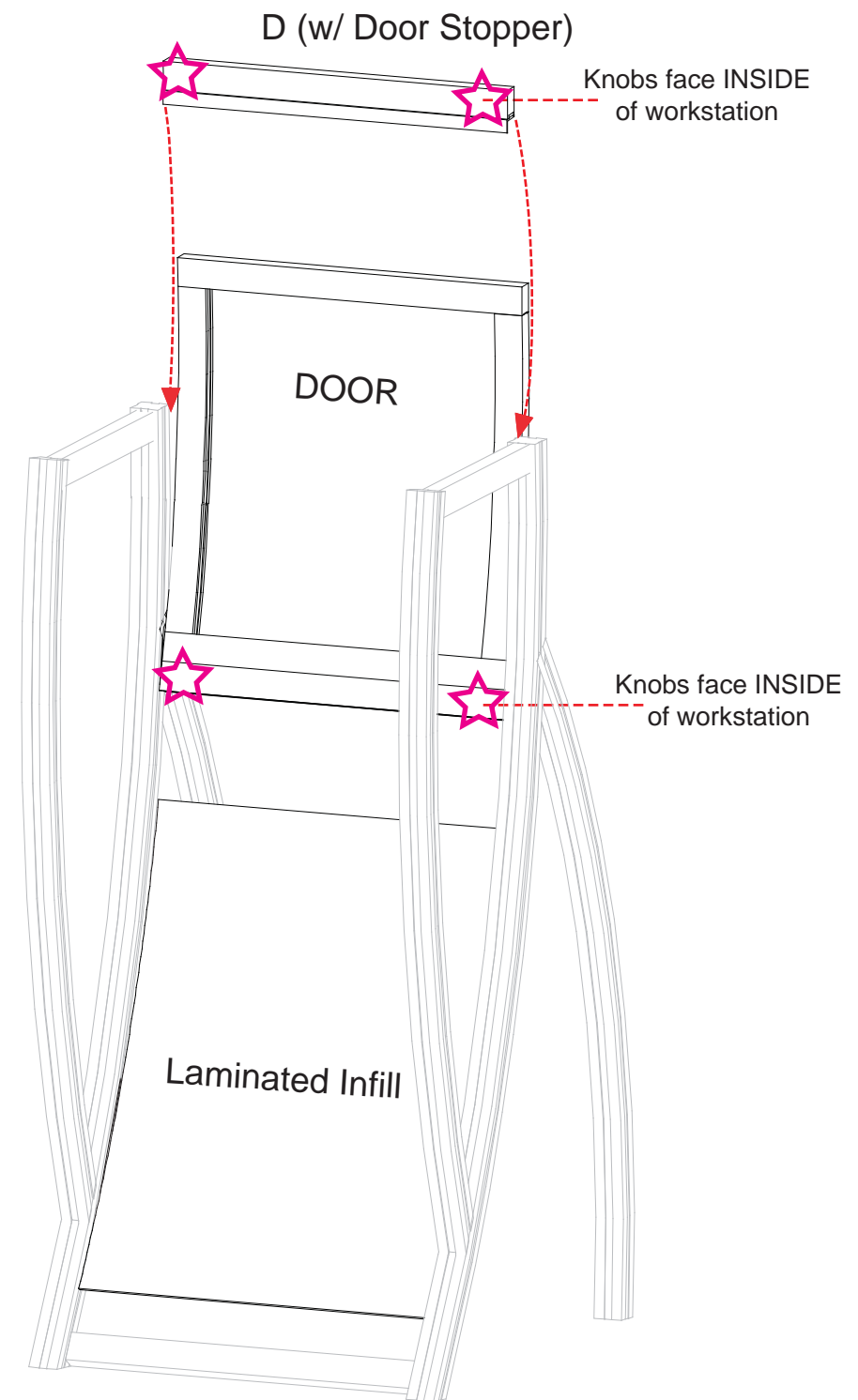
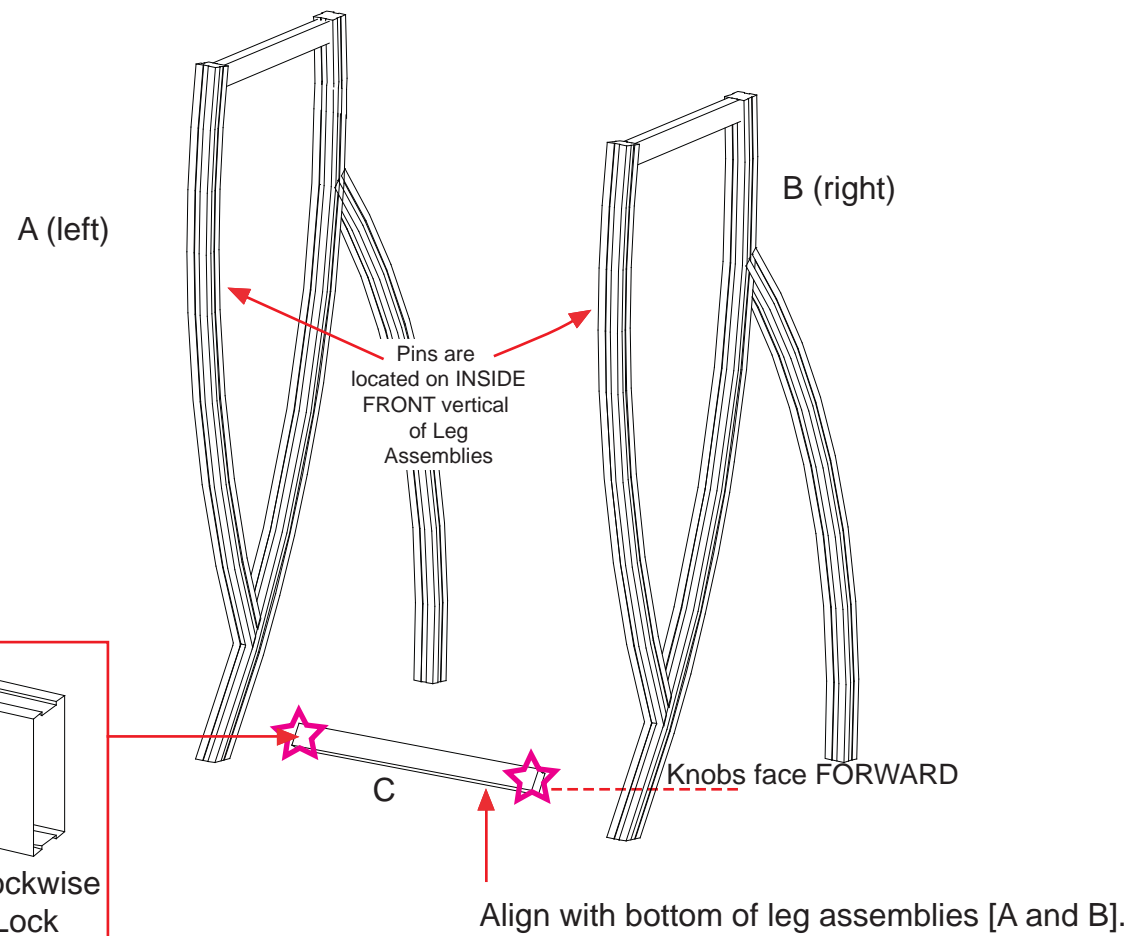

WHEN DISASSEMBLING TIGHTEN ALL KNOBS TO PREVENT LOSS DURING SHIPPING

866.652.2100

Part Number	Description
E	Horizontal Extrusion
F	Horizontal Extrusion

Step 2:

- A) Attach horizontal extrusion [E] between vertical leg assemblies [A and B] as shown below.
- B) Insert Laminated infill into grooves of vertical leg assemblies [A and B].
- C) Attach upper horizontal extrusion [F] between vertical leg assemblies [A and B] atop infill.
- D) Place internal shelf into assembled pedestal atop pins..
- E) Set Counter atop assembled pedestal and secure with Velcro straps attached to underside of top.

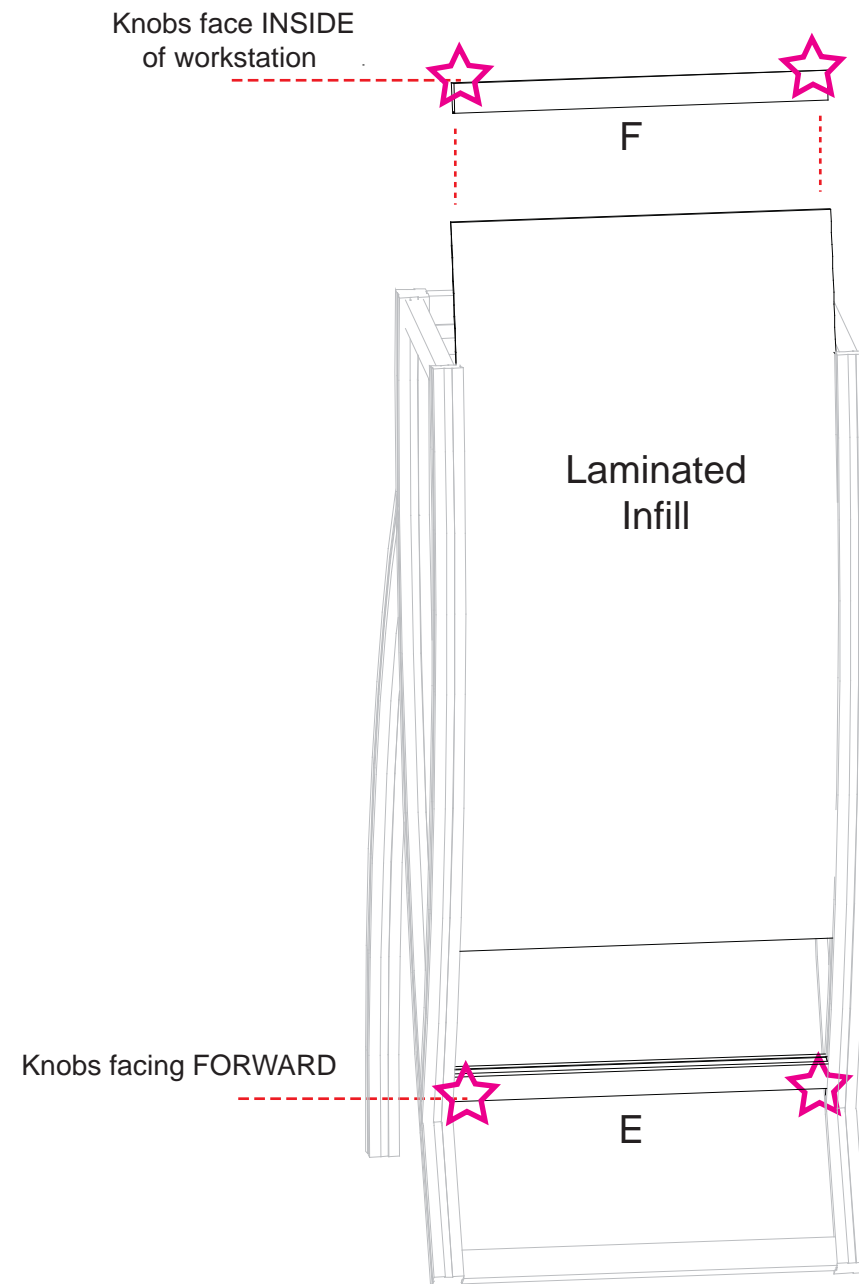

Place internal shelf into workstation then place counter atop assembled workstation.

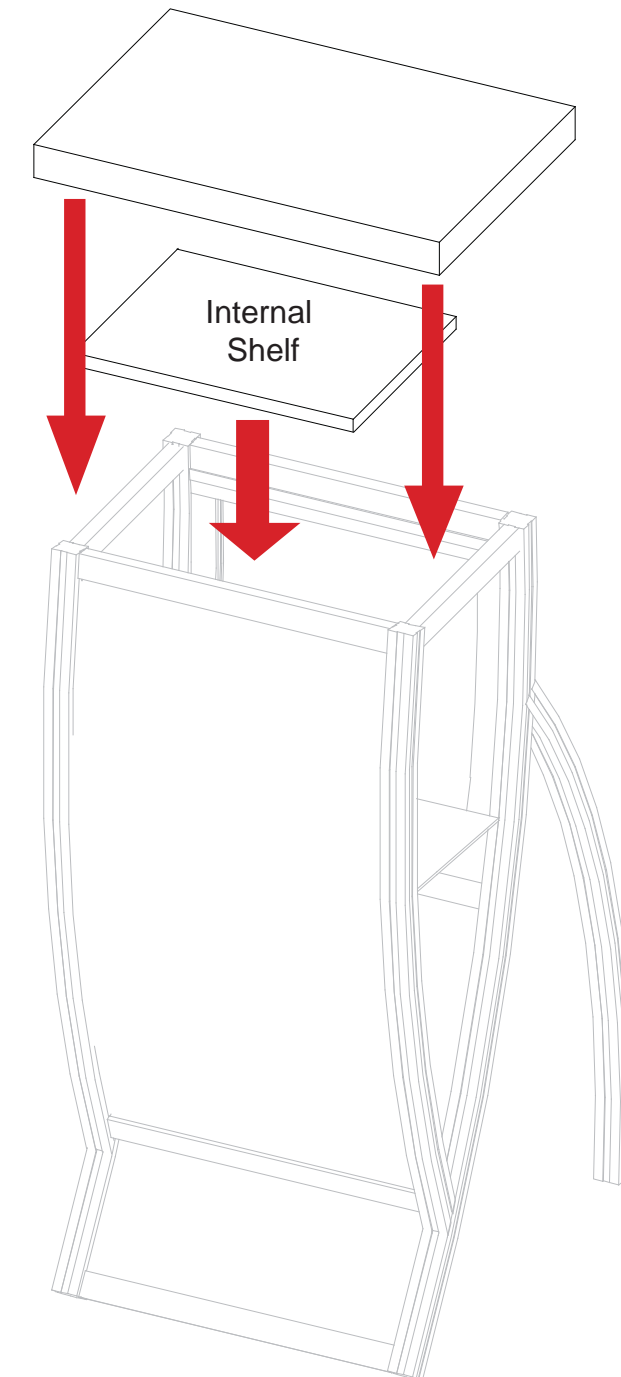

WHEN DISASSEMBLING TIGHTEN ALL KNOBS TO PREVENT LOSS DURING SHIPPING

866.652.2100

Part Number	Description
G	Curved Monitor Mount Extrusion

Step 3:

- A) Slide Connection Bar into lower leg assembly. Slide upper vertical over bar and secure both.
- B) Attach Monitor Mount to vertical as shown in Detail below.

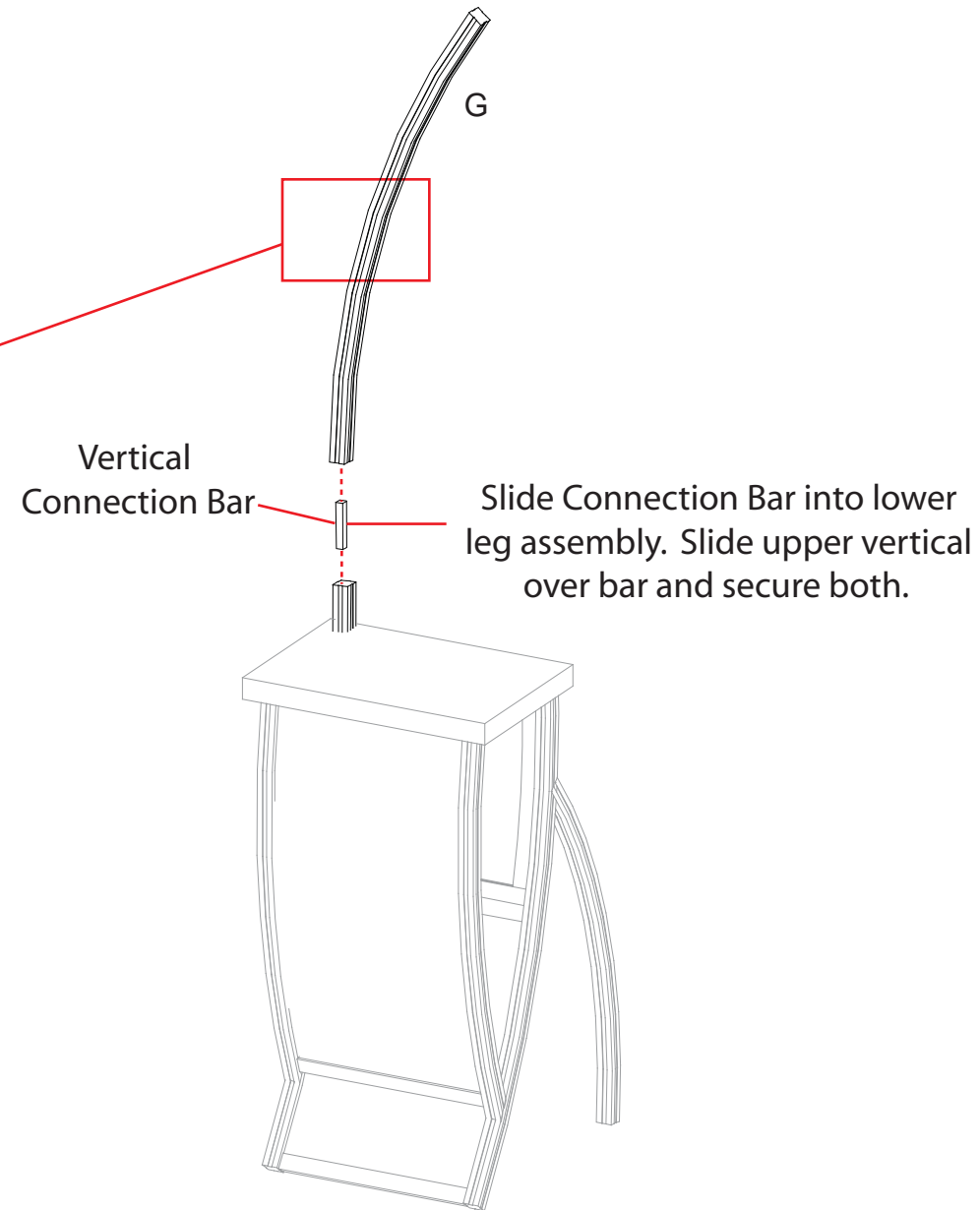
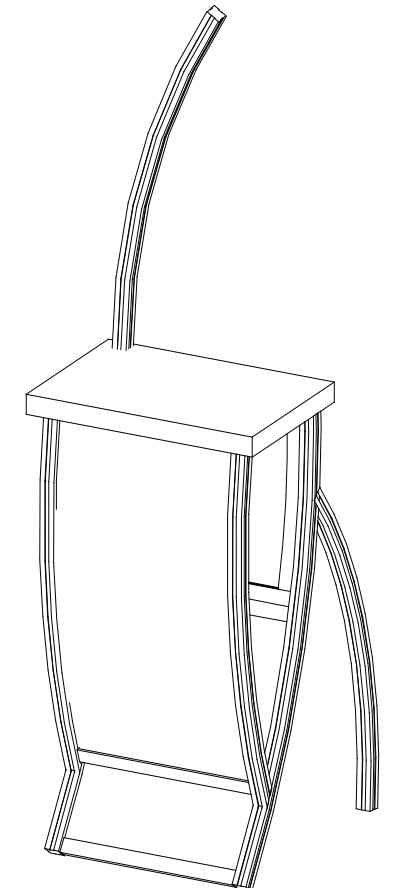

MONITOR MOUNT
Attach monitor mount to vertical extrusions after assembly.

Slide Mount into Groove of Vertical Extrusion.
Tighten Setscrew
Attach top Plate and tighten screws

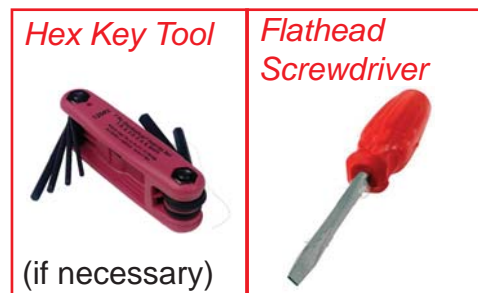

WHEN DISASSEMBLING TIGHTEN ALL KNOBS TO PREVENT LOSS DURING SHIPPING

Case #1 - Backwall Components

Top View of each Level

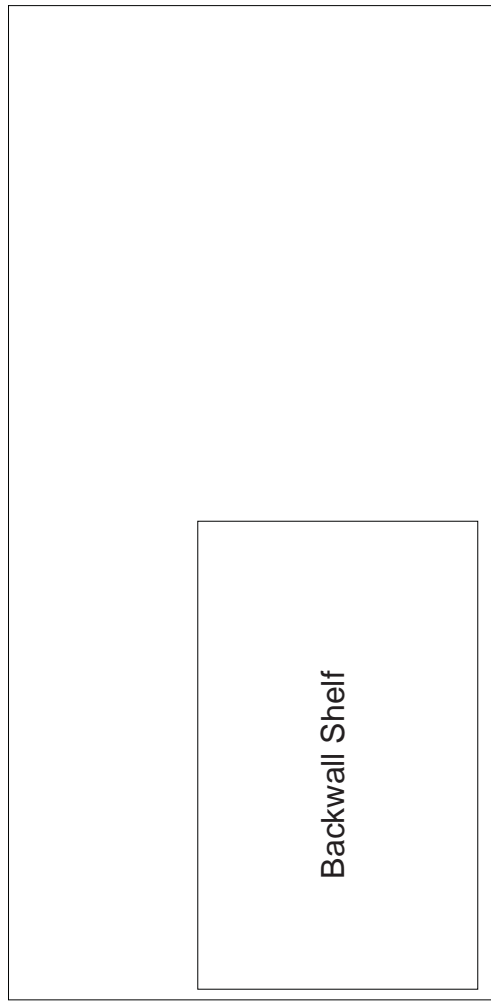

Level 5

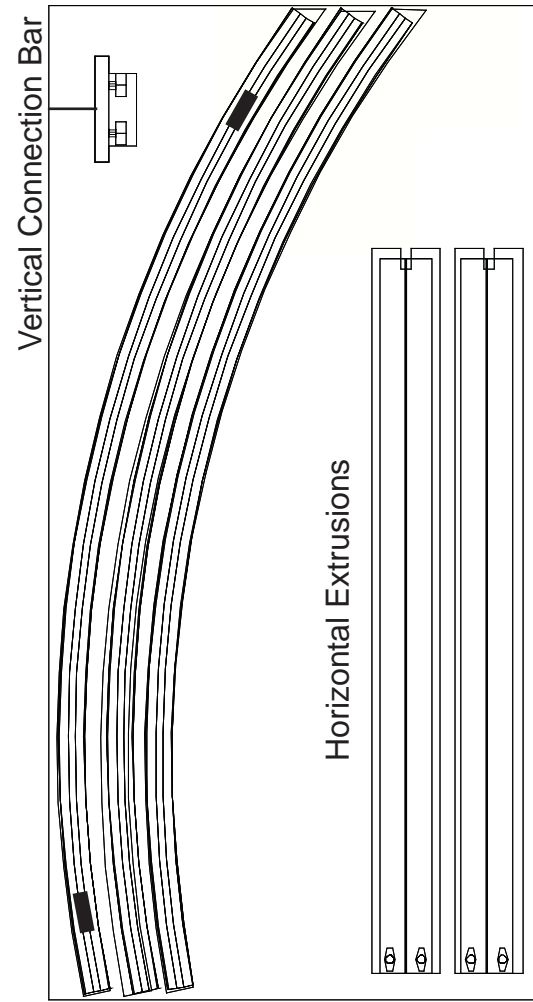

Level 4

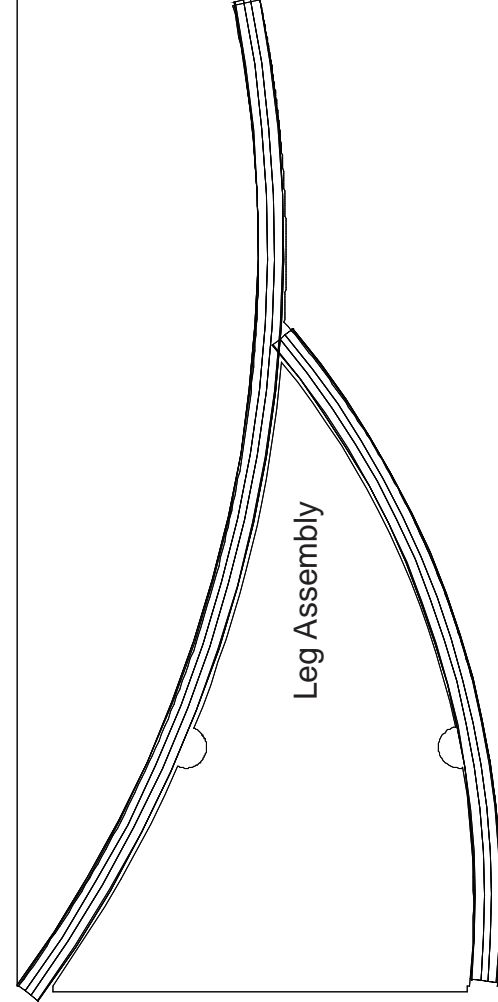

Level 3

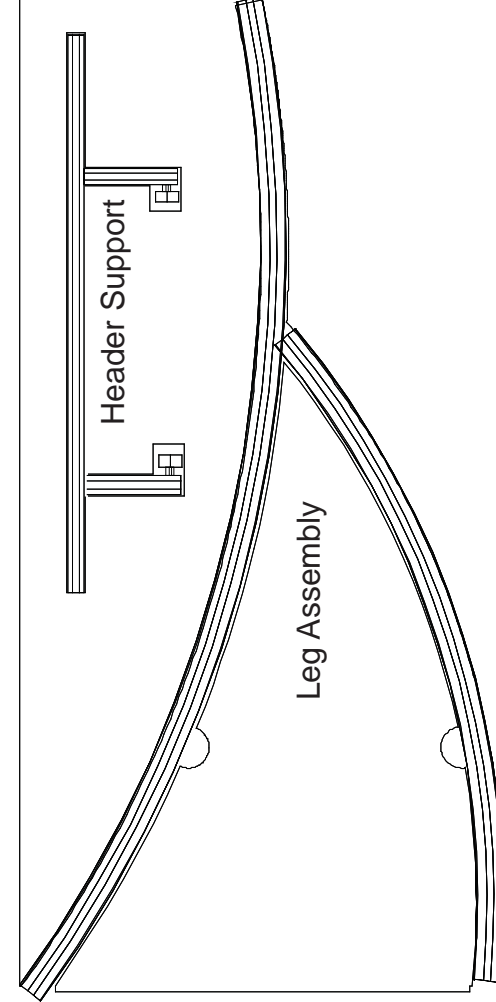

Level 2

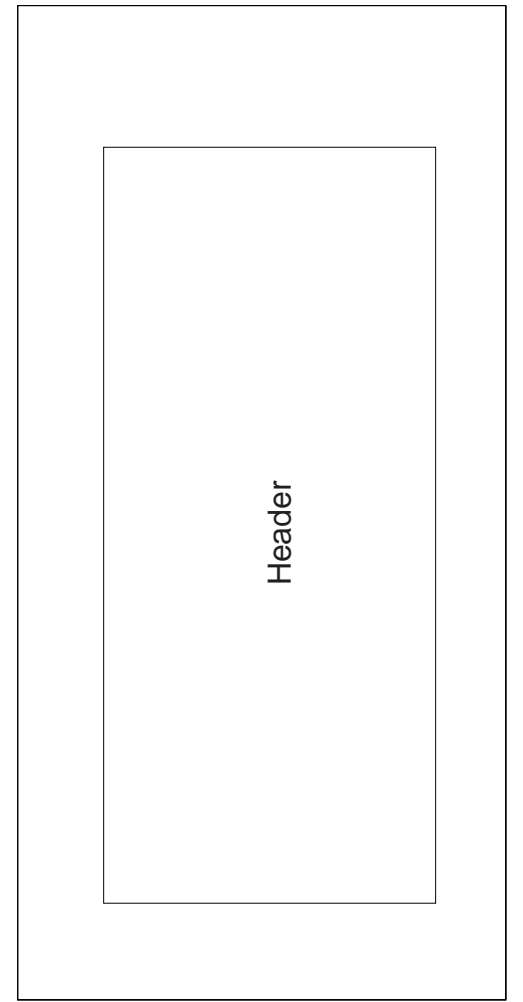

Level 1

WHEN DISASSEMBLING TIGHTEN ALL KNOBS TO PREVENT LOSS DURING SHIPPING

Case #2 - Sidewall Components

Top View of each Level

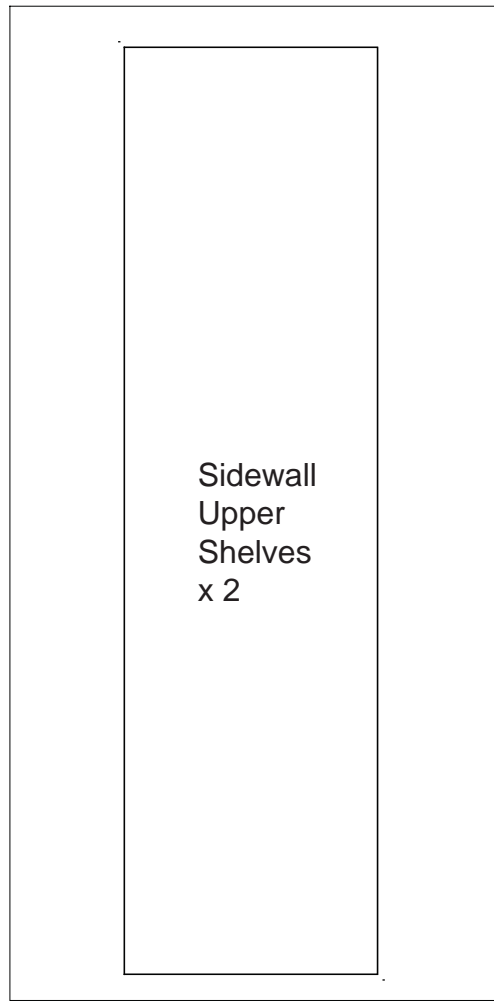

Level 5

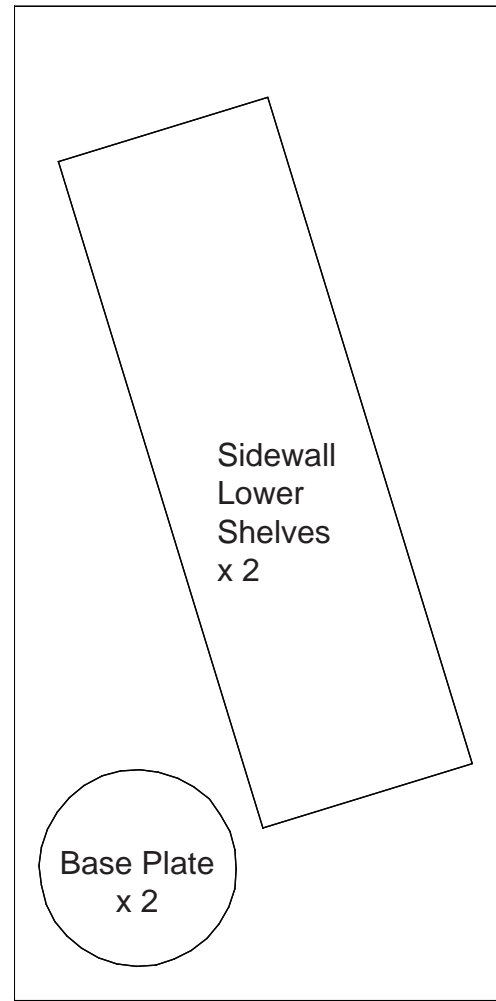

Level 4

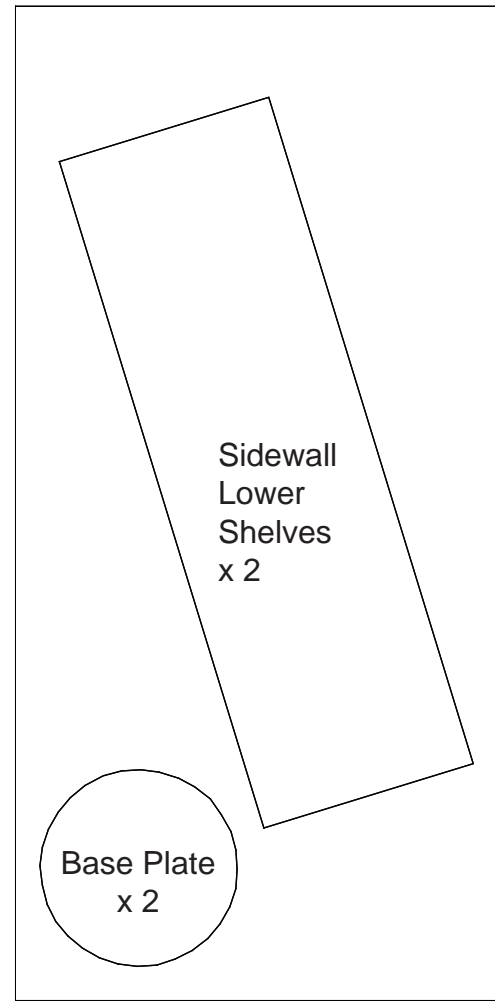

Level 3

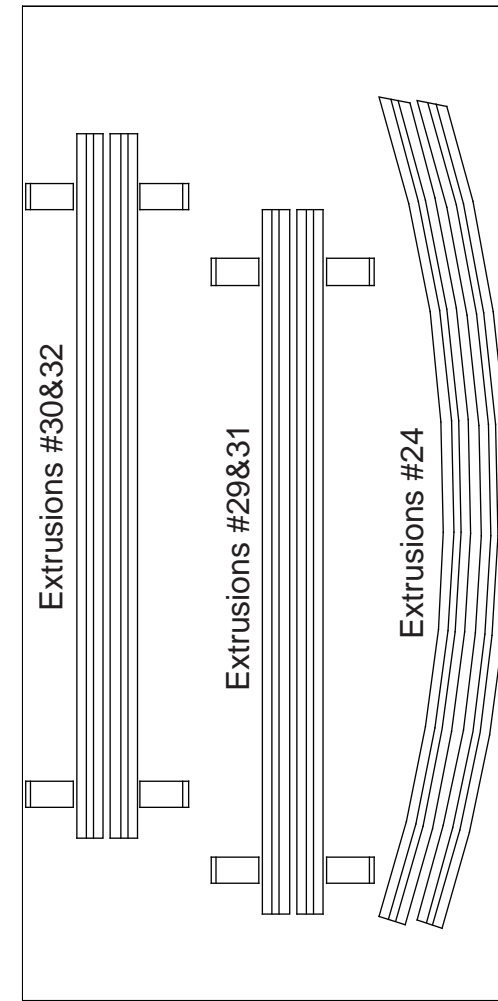

Level 2

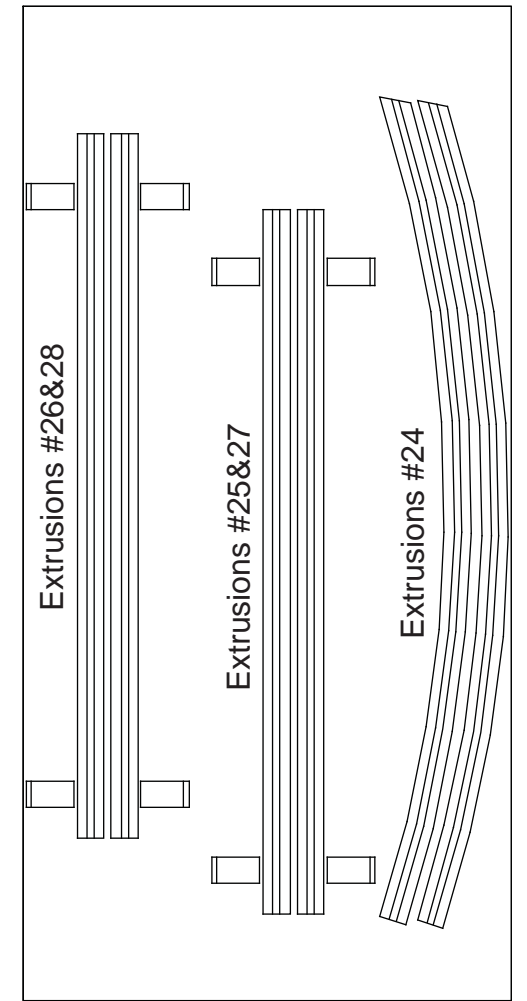

Level 1

WHEN DISASSEMBLING TIGHTEN ALL KNOBS TO PREVENT LOSS DURING SHIPPING

Case #3 - Backwall Components

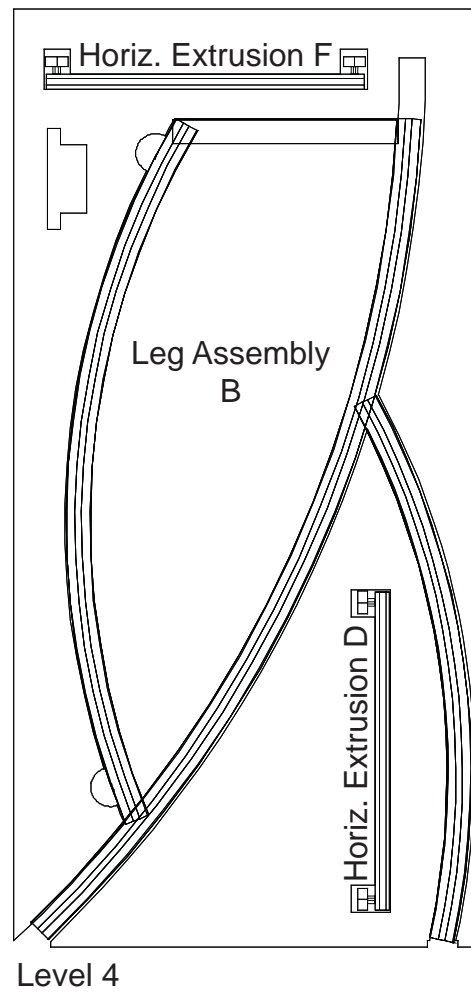
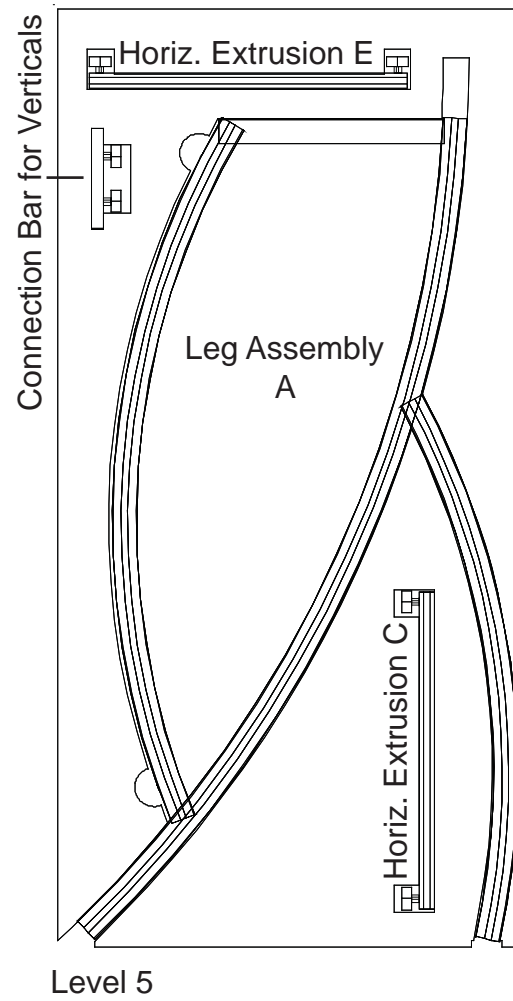

Top View of each Level

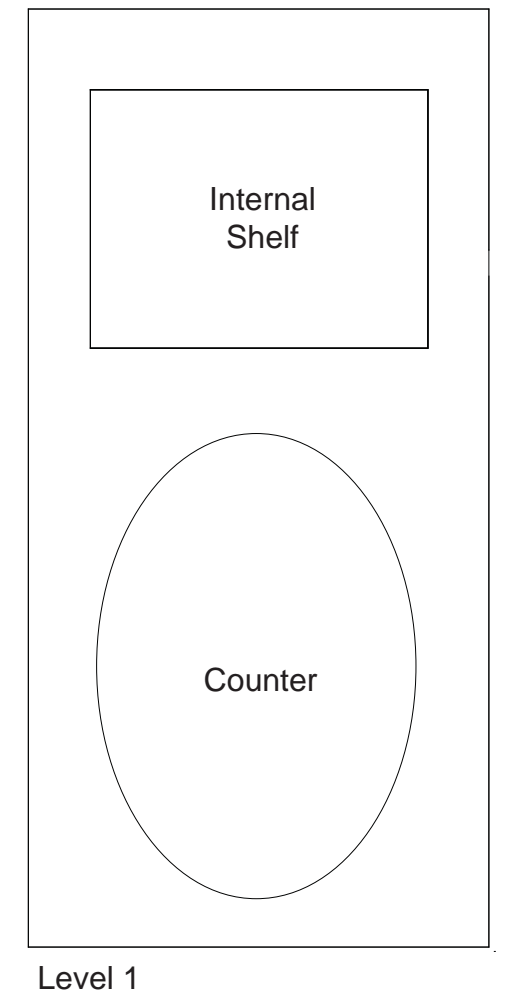
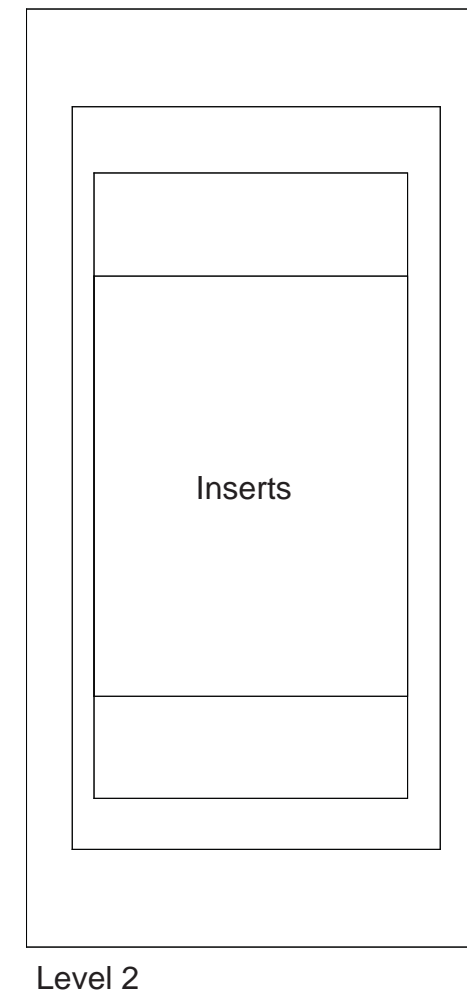
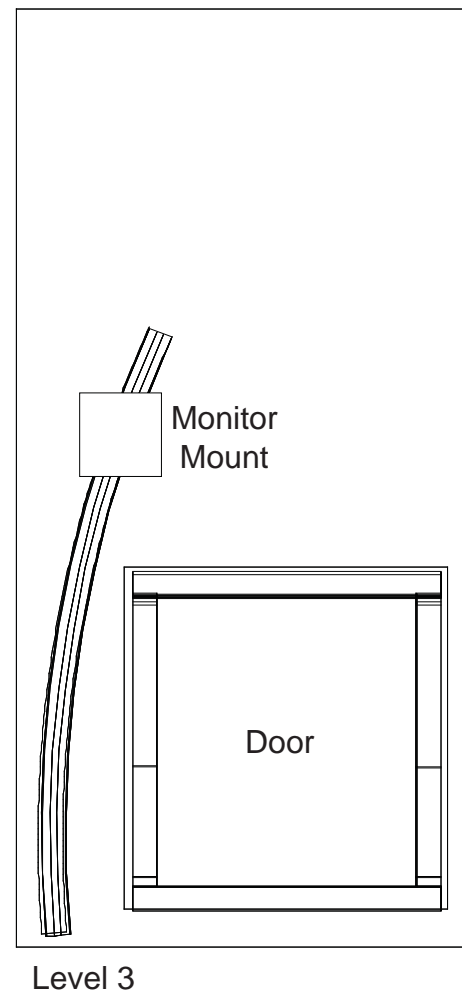

WHEN DISASSEMBLING TIGHTEN ALL KNOBS TO PREVENT LOSS DURING SHIPPING

Case #4 - Backwall Components

Top View of each Level

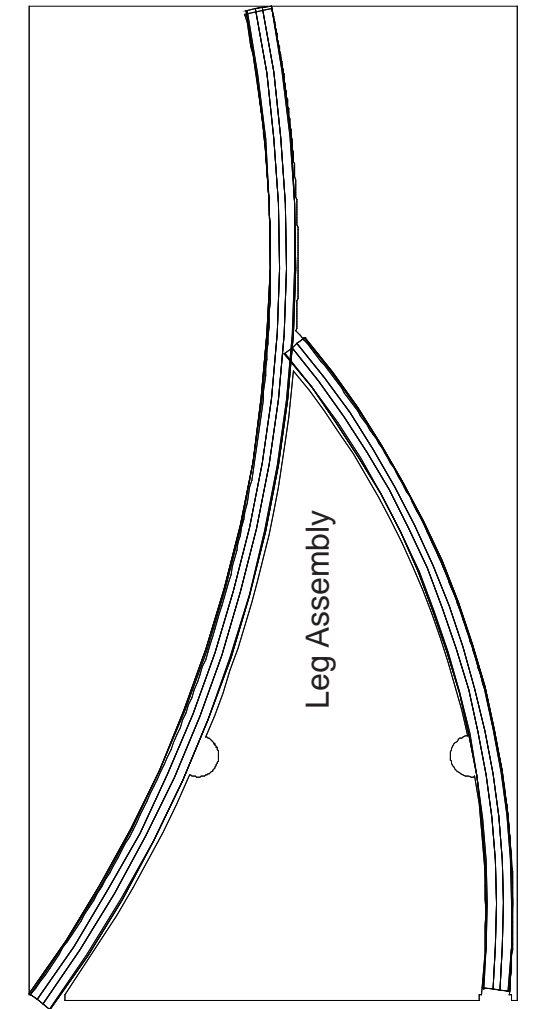
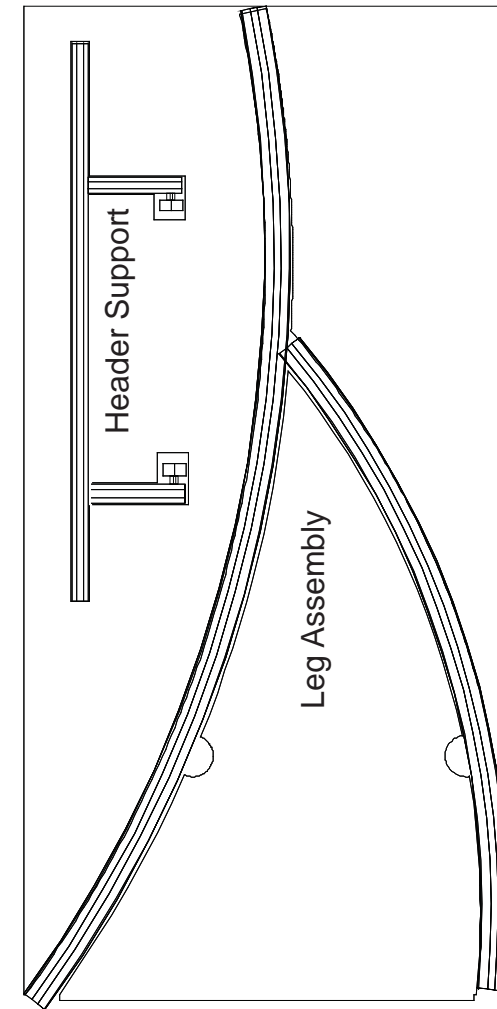
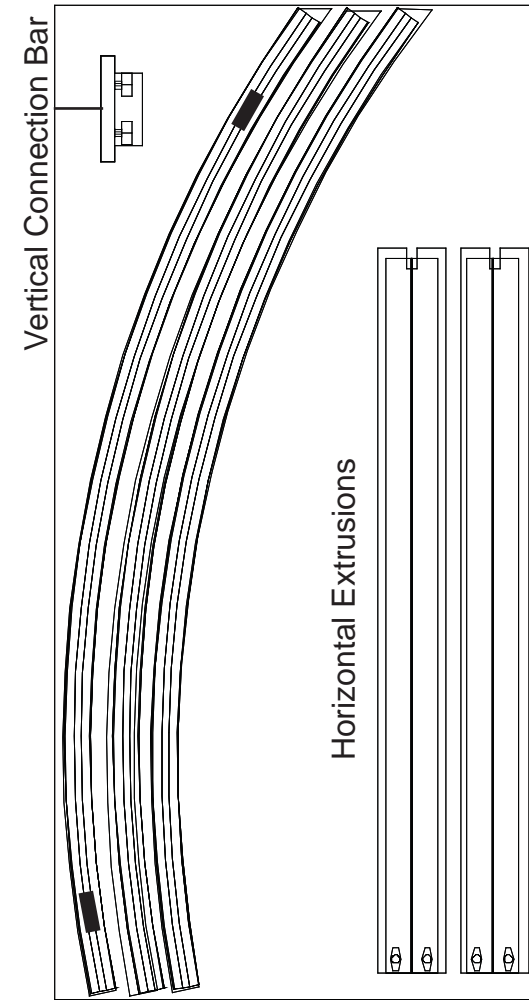
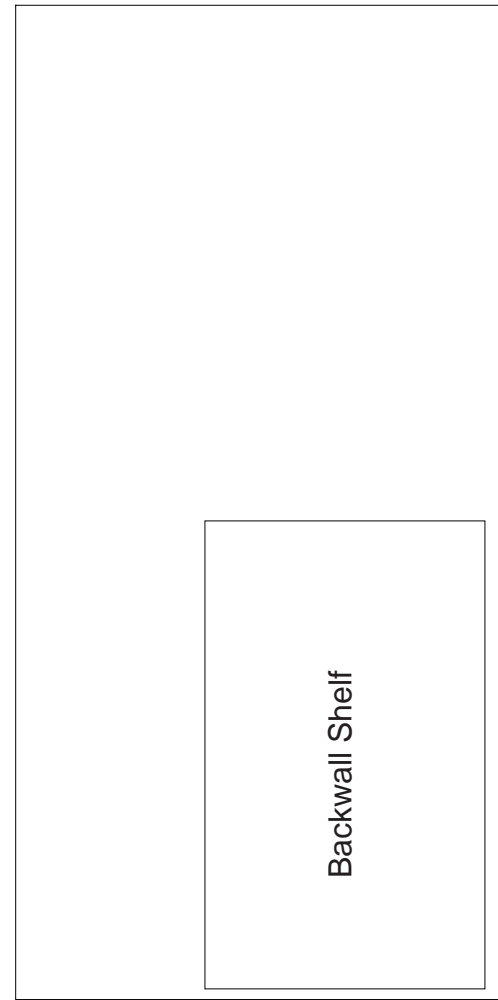
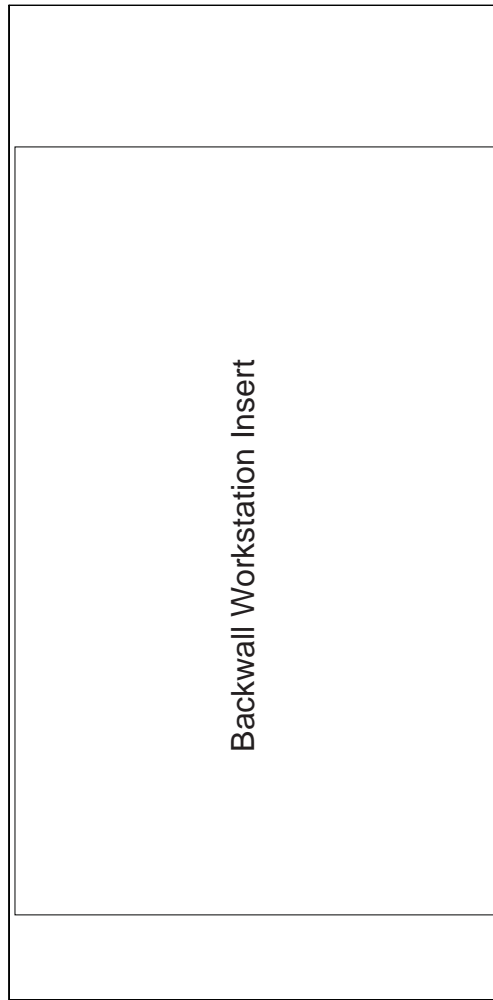

WHEN DISASSEMBLING TIGHTEN ALL KNOBS TO PREVENT LOSS DURING SHIPPING

Case #5 - Backwall Components

Top View of each Level

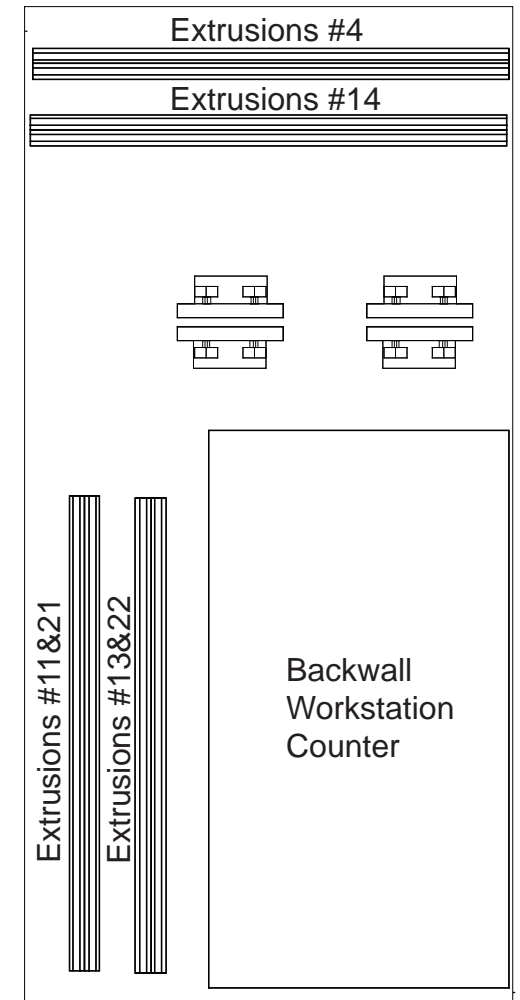
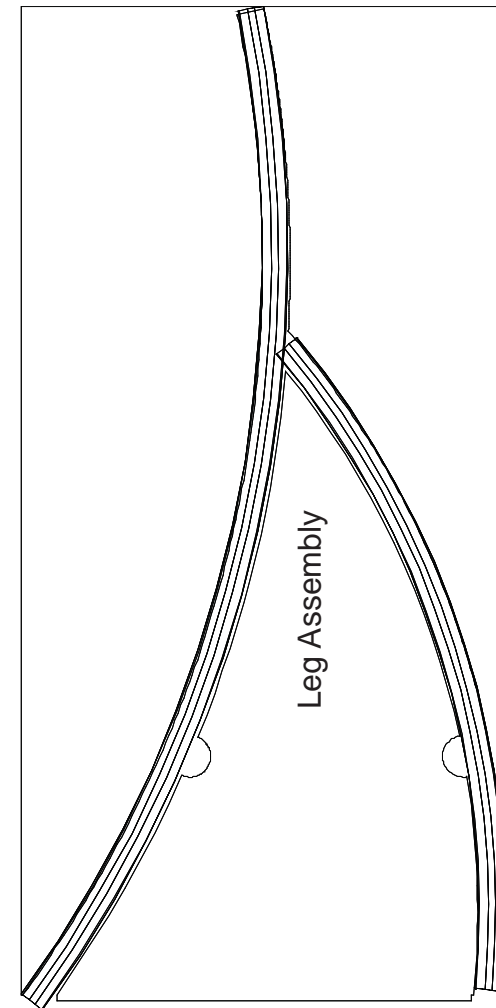
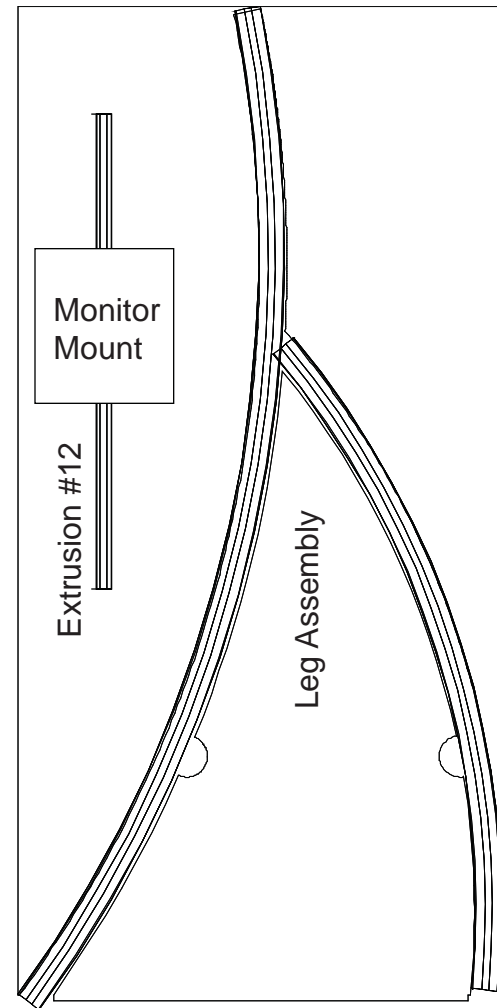
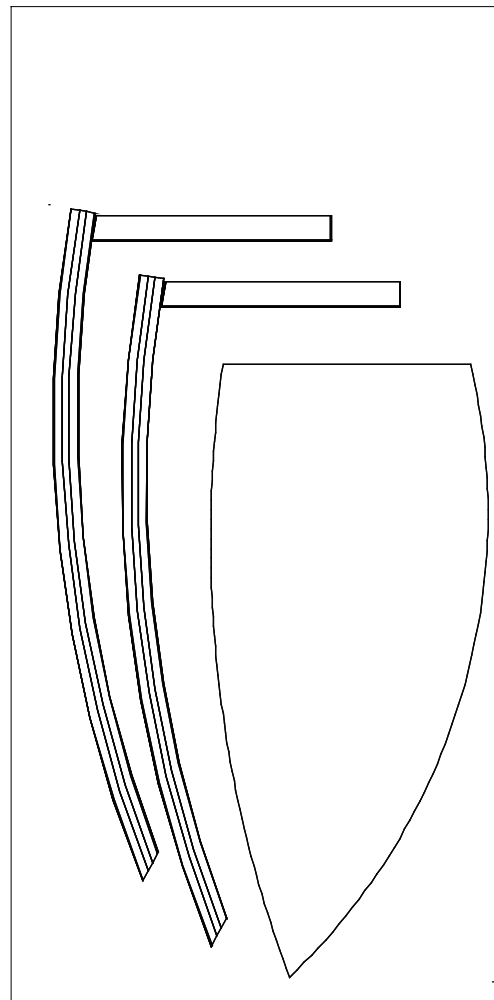

- Additional Items
- Box of Graphics
 - Box of (3) Lights
 - Box of (3) Lights

WHEN DISASSEMBLING TIGHTEN ALL KNOBS TO PREVENT LOSS DURING SHIPPING

Case #6 - Backwall Components

Top View of each Level

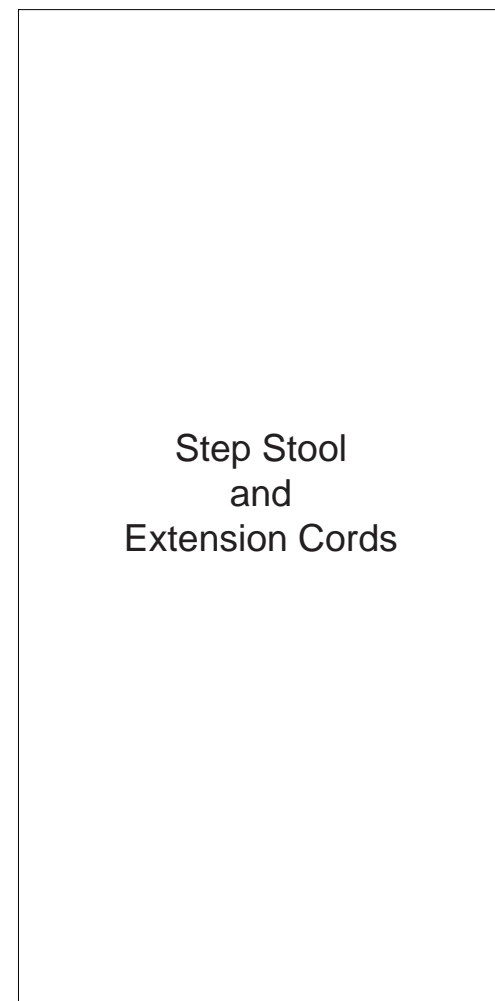

Step Stool
and
Extension Cords

Level 1

Additional Items

- Box of (4) Literature Shelves
- Box of (2) Literature Shelves
- Box of Setup Hardware

WHEN DISASSEMBLING TIGHTEN ALL KNOBS TO PREVENT LOSS DURING SHIPPING