

# euro It | *HYBRIDS*

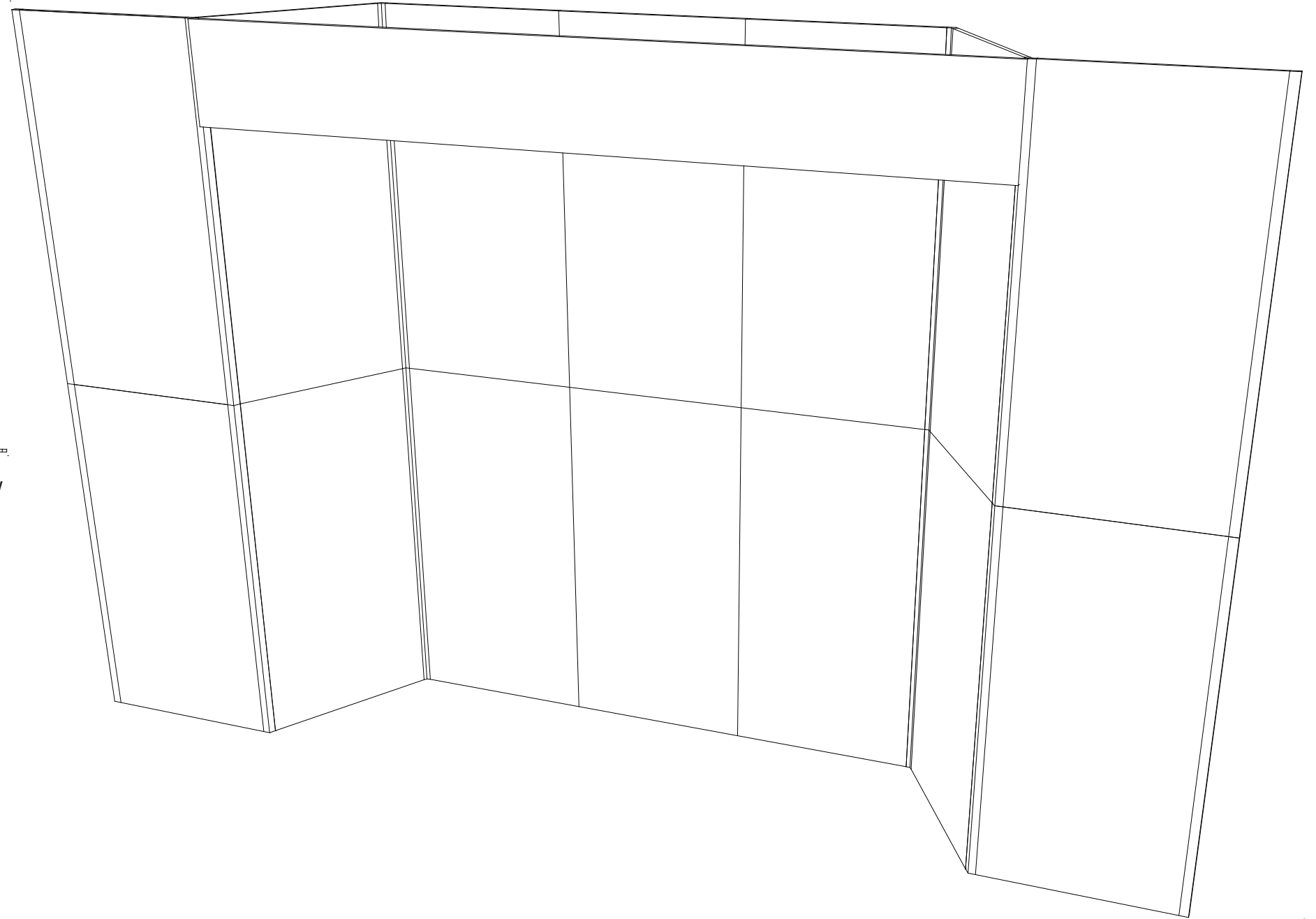
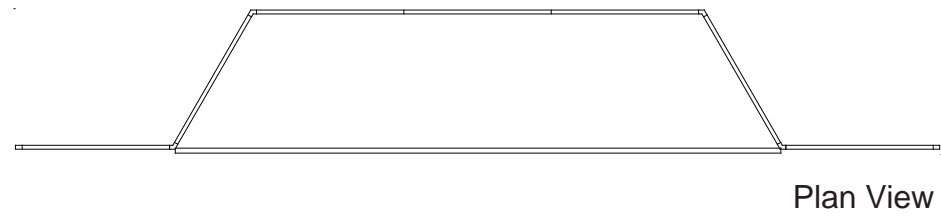

# euro lt | HYBRIDS

## Euro LT Hybrids General Setup Instructions

### Using Your Setup Instructions

The Euro LT Hybrids Setup Instructions are created specifically for your configuration. They are laid out sequentially in levels, including exploded views, and a logical series of detailed steps to assemble the main structure and components. We encourage you to study the instructions **before** attempting to assemble your exhibit.

### Cleaning and Packing Your Display

- 1) When cleaning laminate countertops or panels use mild cleansers and a soft material such as cotton.
- 2) Keep all display components away from extreme heat and long exposure to sunlight to avoid warping and fading.
- 3) Retain all packing material. It will make re-packing much easier and will reduce the likelihood of shipping damage.

Level 1 = Blue  
 Level 2 = Red  
 Level 3 = Green  
 Level 4 = Black

#### Color Code

The top clip is color coded to distinguish the level. The color coded clip also contains the numbered label

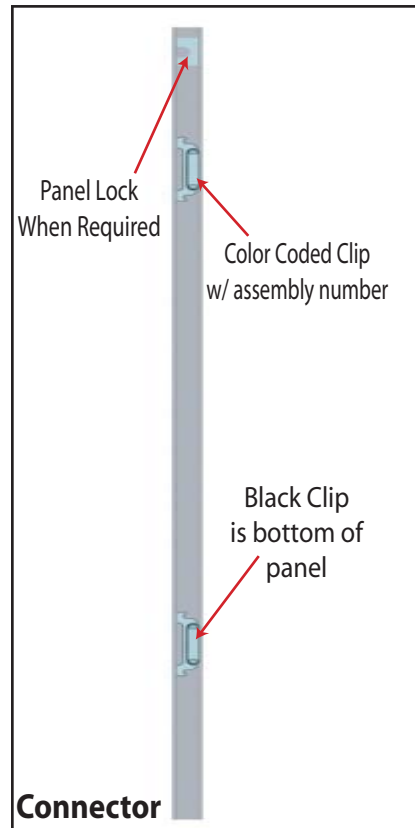

Each component has 2 clips, the lower clip is ALWAYS black..

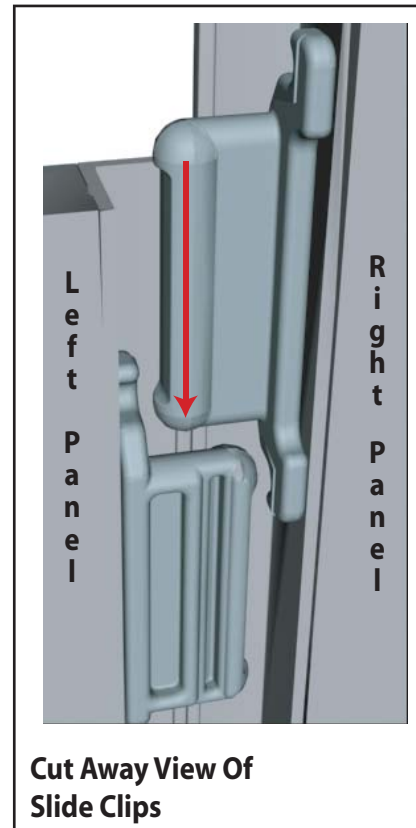

Components connect together by aligning them and sliding downward connecting clips together.

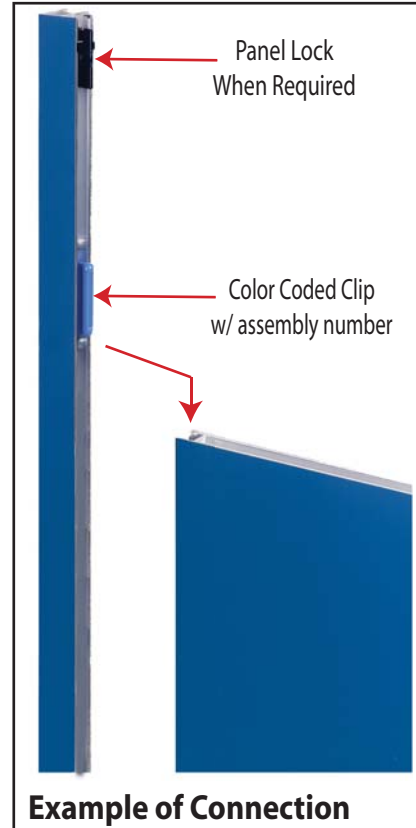

Configurations are assembled from left to right, usually starting with #1 and following the numbered sequence.



The first level of components contains panel locks that are located at the top of the panel for extra stability and a seamless connection. When disassembling panels, twist top connection slightly and lift right panel upward.

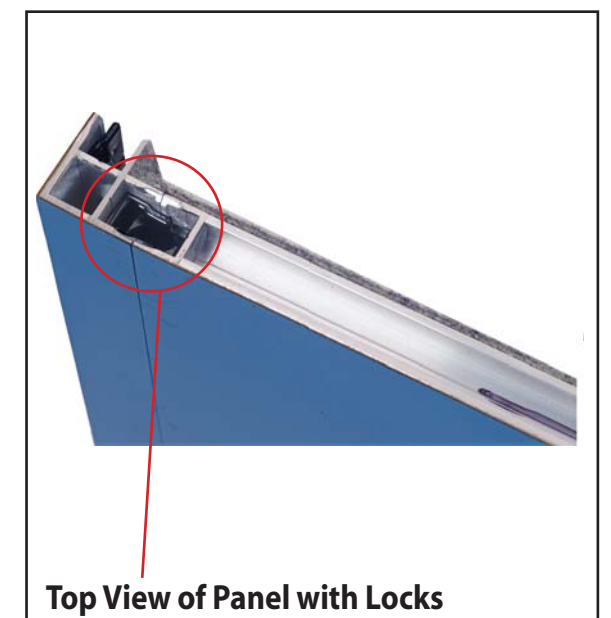

866.652.2100

Item Number	Description
1	46" h End Cap
2	23" w x 46" h Flat Panel
3	46" h 120° Connector
4	23" w x 46" h Flat Panel
5	46" h 120° Connector
6	23" w x 46" h Flat Panel
7	23" w x 46" h Flat Panel
8	23" w x 46" h Flat Panel
9	46" h 120° Connector
10	23" w x 46" h Flat Panel
11	46" h 120° Connector
12	23" w x 46" h Flat Panel
13	46" h End Cap

Steps:  
 1) Assemble by starting at panel #1\* and continue in numerical order.

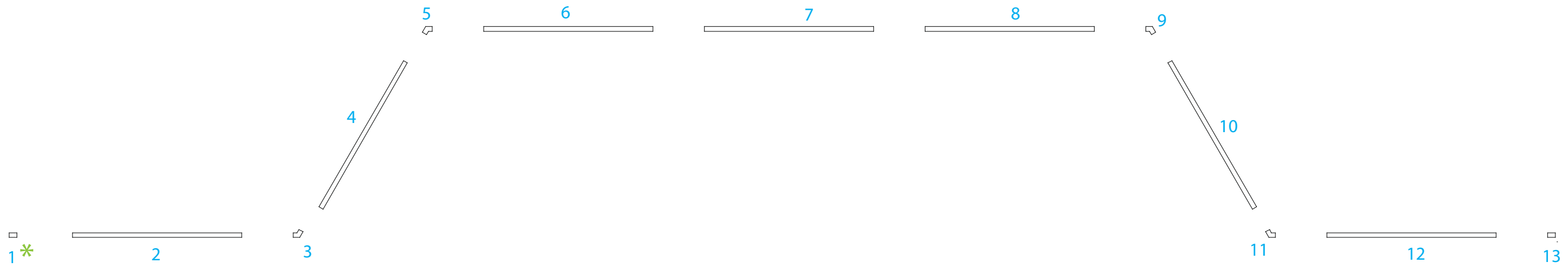
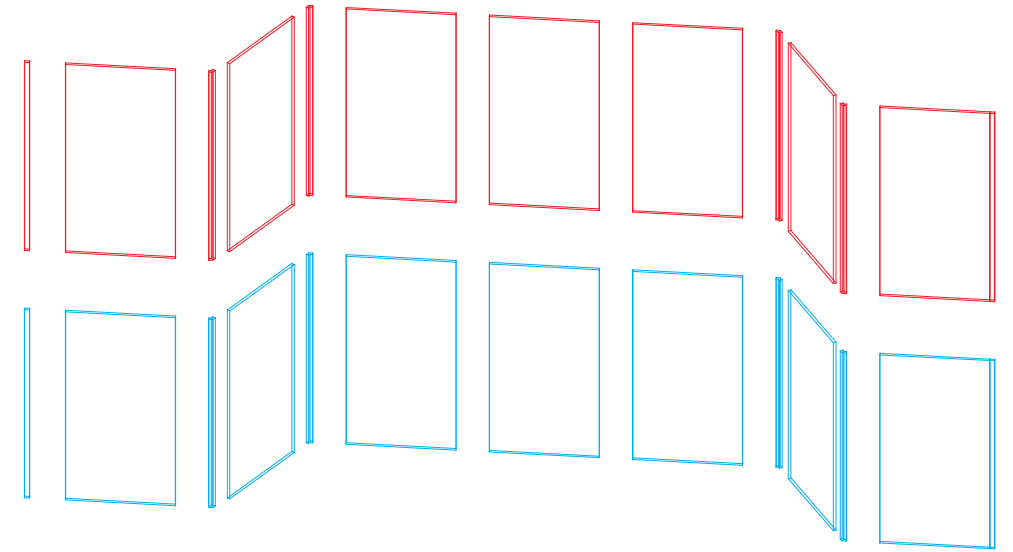

866.652.2100

Item Number	Description
1	46" h End Cap
2	23" w x 46" h Flat Panel
3	46" h 120° Connector
4	23" w x 46" h Flat Panel
5	46" h 120° Connector
6	23" w x 46" h Flat Panel
7	23" w x 46" h Flat Panel
8	23" w x 46" h Flat Panel
9	46" h 120° Connector
10	23" w x 46" h Flat Panel
11	46" h 120° Connector
12	23" w x 46" h Flat Panel
13	46" h End Cap

Steps:  
 1) Assemble by starting at panel #1\* and continue in numerical order.

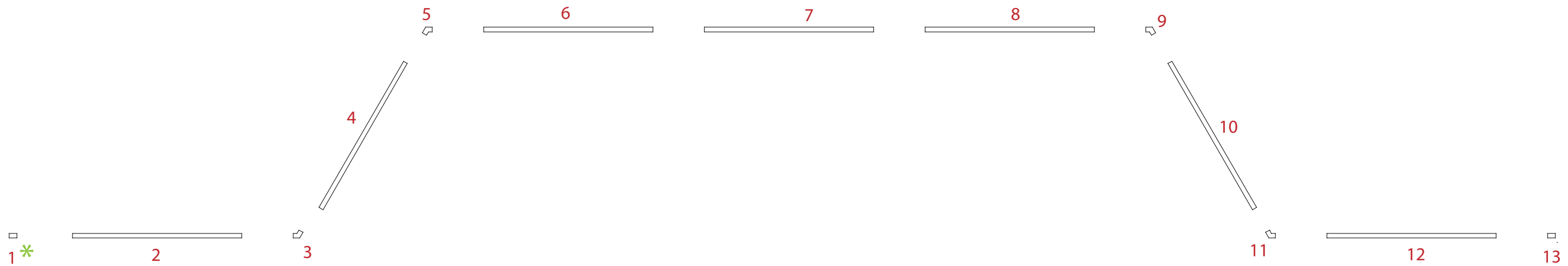
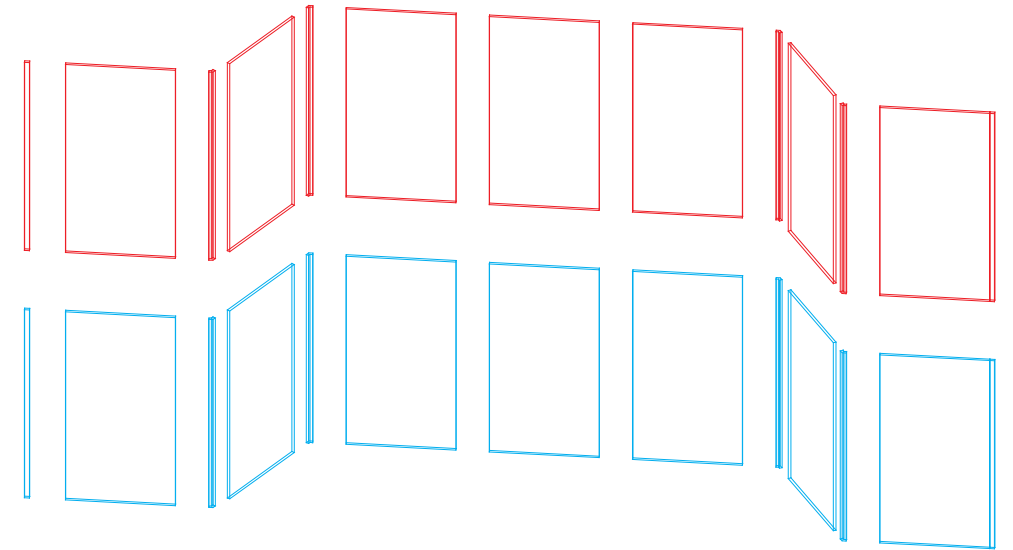

**Header Kit Assembly**

*Step 1*

NOTE: Straight edges meet

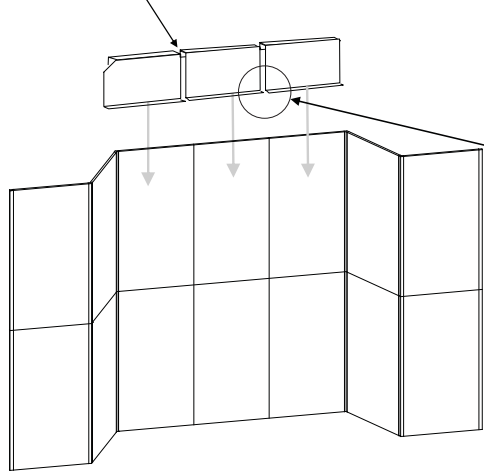

Hook ceiling supports over top of display panels

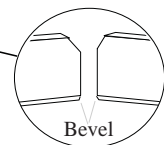

Beveled corners meet here

Hook ceiling supports over top of display panels. NOTE: Make sure beveled aluminum channels on supports and straight edge of supports meet as shown.

*Step 2*

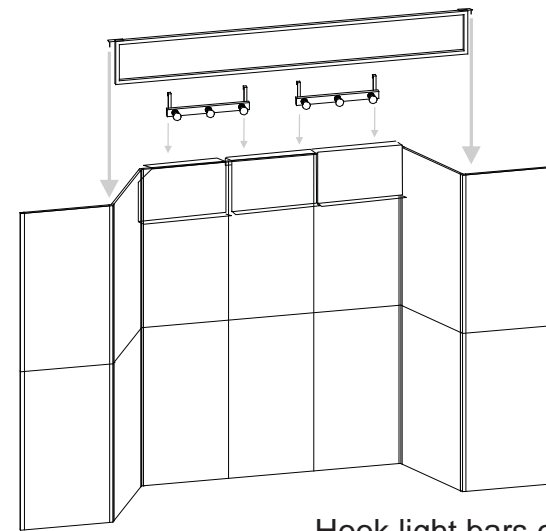

Hook light bars over the ceiling supports, screw in light bulbs and let the cords hang over the back of the display. Then hook header over panel tops.

*Step 3*

Install ceiling diffuser panels

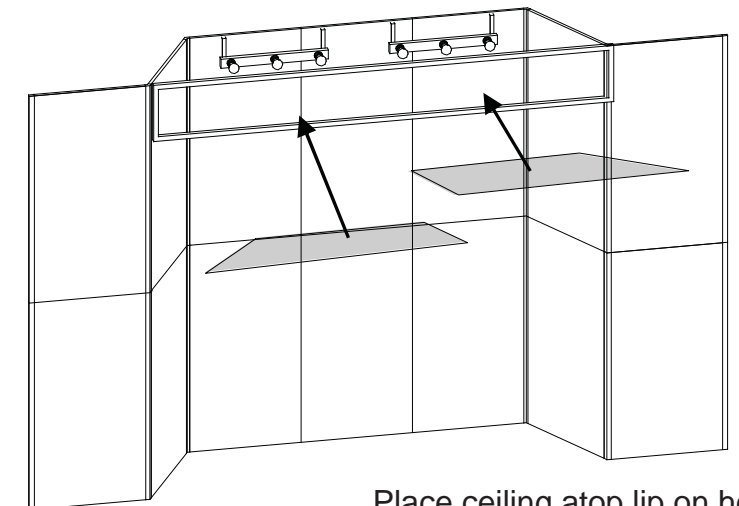

Place ceiling atop lip on header and ceiling supports.

Header Piece

---

Header Piece

---

Ceiling Piece

---

Ceiling Piece

---

Panel # 2

---

Panel # 4

---

Panel # 6

---

Panel # 7

---

Panel # 8

---

Panel # 10

---

Panel # 12

---

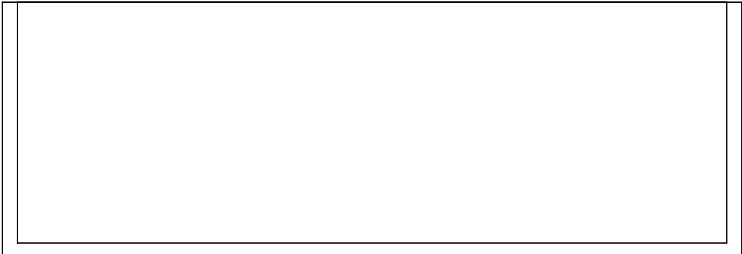

Case 1 of 3

Connectors

---

Panel # 2

---

Panel # 4

---

Panel # 6

---

Panel # 7

---

Panel # 8

---

Panel # 10

---

Panel # 12

---

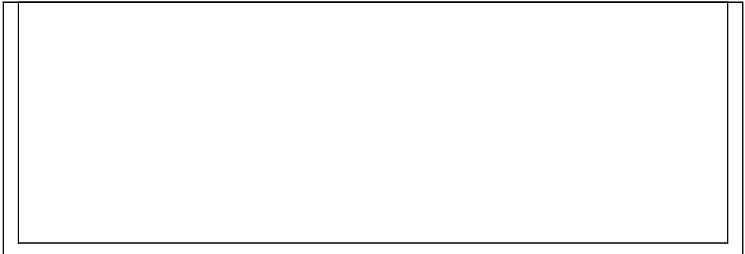

Case 2 of 3

(3) 3-Bulb Light Bar	Ceiling Supports & Setup Hardware
Ceiling Supports	Ceiling Supports

---

Beacon Tower Components

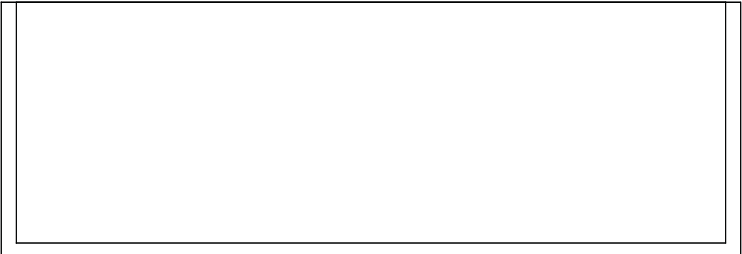

Case 3 of 3

- Header Piece

---

- Header Piece

---

- Ceiling Piece

---

- Ceiling Piece

---

- Panel # 2

---

- Panel # 4

---

- Panel # 6

---

- Panel # 7

---

- Panel # 8

---

- Panel # 10

---

- Panel # 12

---

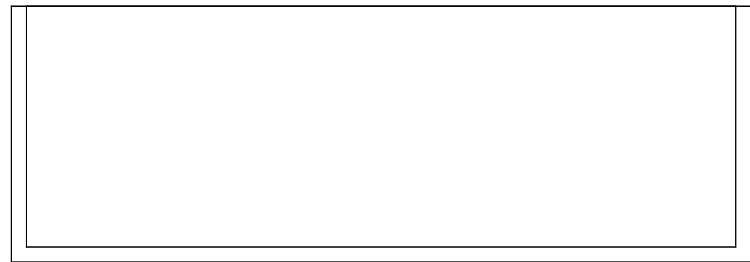
Case 1 of 3

Connectors

---

- Panel # 2

---

- Panel # 4

---

- Panel # 6

---

- Panel # 7

---

- Panel # 8

---

- Panel # 10

---

- Panel # 12

---

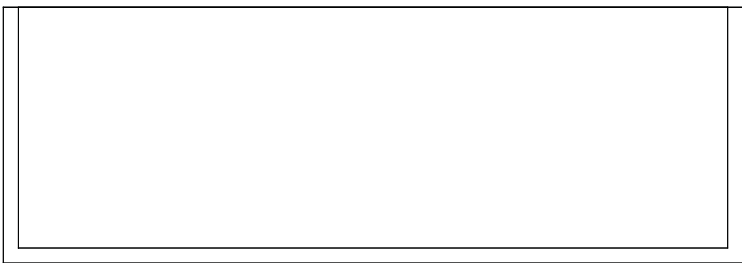
Case 2 of 3

- (3) 3-Bulb Light Bar
  - Ceiling Supports & Setup Hardware
  - Ceiling Supports
  - Ceiling Supports
- Beacon Tower Components
- 

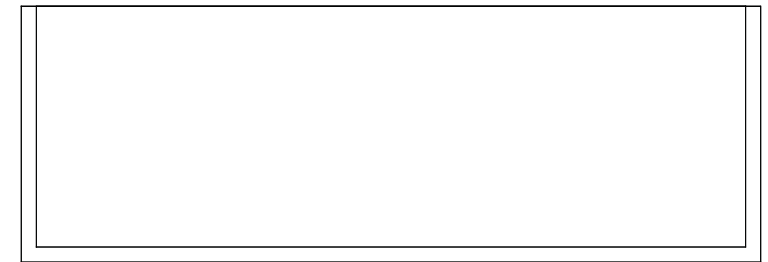

Case 3 of 3

- Header Piece

---

- Header Piece

---

- Ceiling Piece

---

- Ceiling Piece

---

- Panel # 2

---

- Panel # 4

---

- Panel # 6

---

- Panel # 7

---

- Panel # 8

---

- Panel # 10

---

- Panel # 12

---

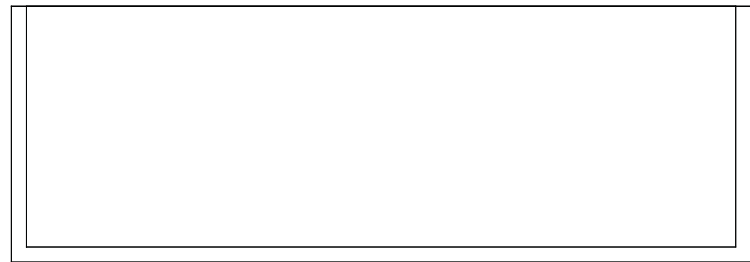
Case 1 of 3

- Connectors

---

- Panel # 2

---

- Panel # 4

---

- Panel # 6

---

- Panel # 7

---

- Panel # 8

---

- Panel # 10

---

- Panel # 12

---

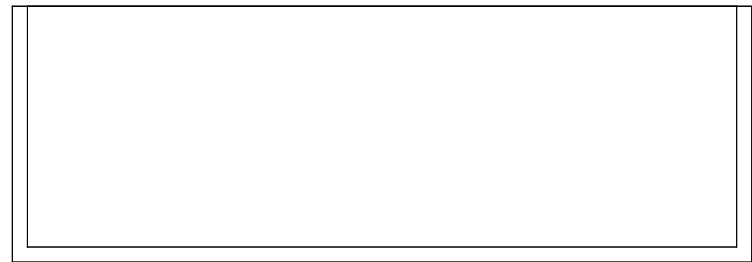
Case 2 of 3

(3) 3-Bulb Light Bar	Ceiling Supports & Setup Hardware
Ceiling Supports	Ceiling Supports

---

Beacon Tower Components

---

Case 3 of 3