

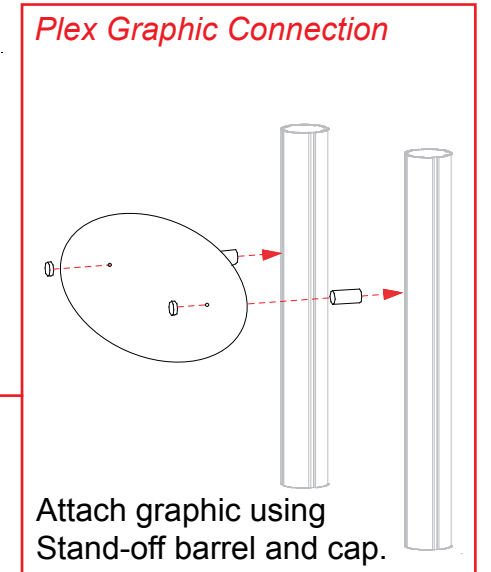

Item	Quantity	Description
1	1	38" h Vertical Extrusion
2	1	38" h Vertical Extrusion
3	1	42" h Vertical Extrusion
3A	1	Plate for Counter Connection
4	1	38" h Vertical Extrusion
5	2	20" w Horizontal Extrusion
6	2	8.5" w Horizontal Extrusion
7	2	20" w Horizontal Extrusion
8	2	8.5" w Horizontal Extrusion
9	4	Internal Shelf Support

Steps:

- 1) Connect horizontal extrusions [5 and 6] between vertical extrusions [1, 2, 3 and 4] resting atop stoppers at approximately 4" up from floor to bottom of metal.
- 2) Set floor in place atop lip of horizontal extrusions.
- 3) Place doors and inserts in place as shown.
- 4) Connect horizontal extrusions [7, and 8] between vertical extrusions [1, 2, 3 and 4] and atop inserts and door.
- 5) Velcro shelf supports to inside of pedestal, then set internal shelf atop supports.
- 6) Place counter atop assembled pedestal, attach [3A] to extrusion [3] then connect smaller counter to [3A].

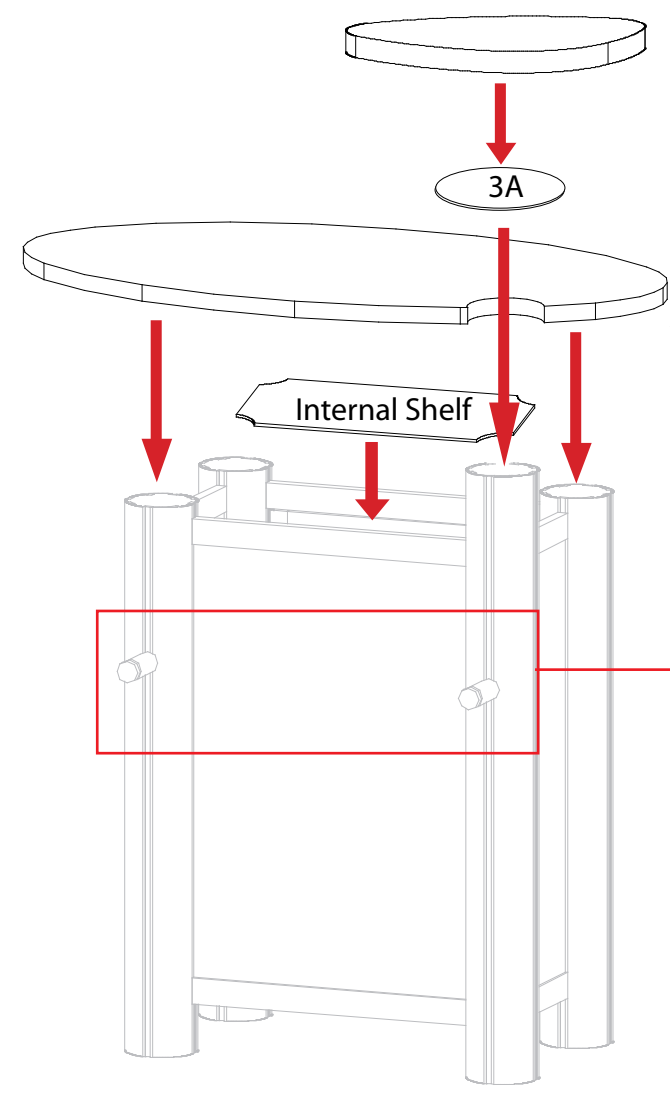
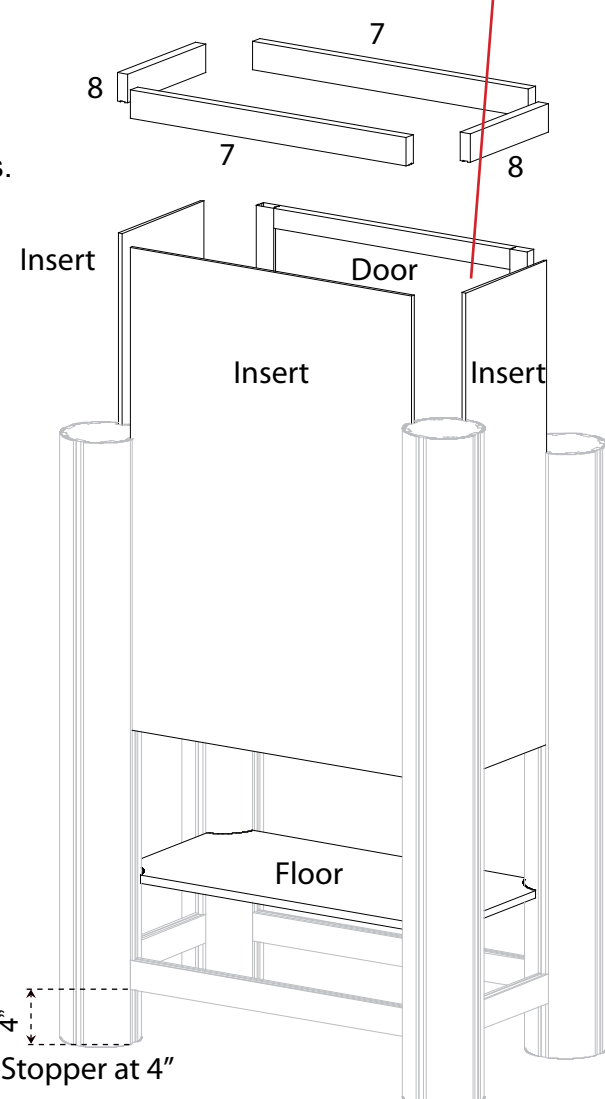
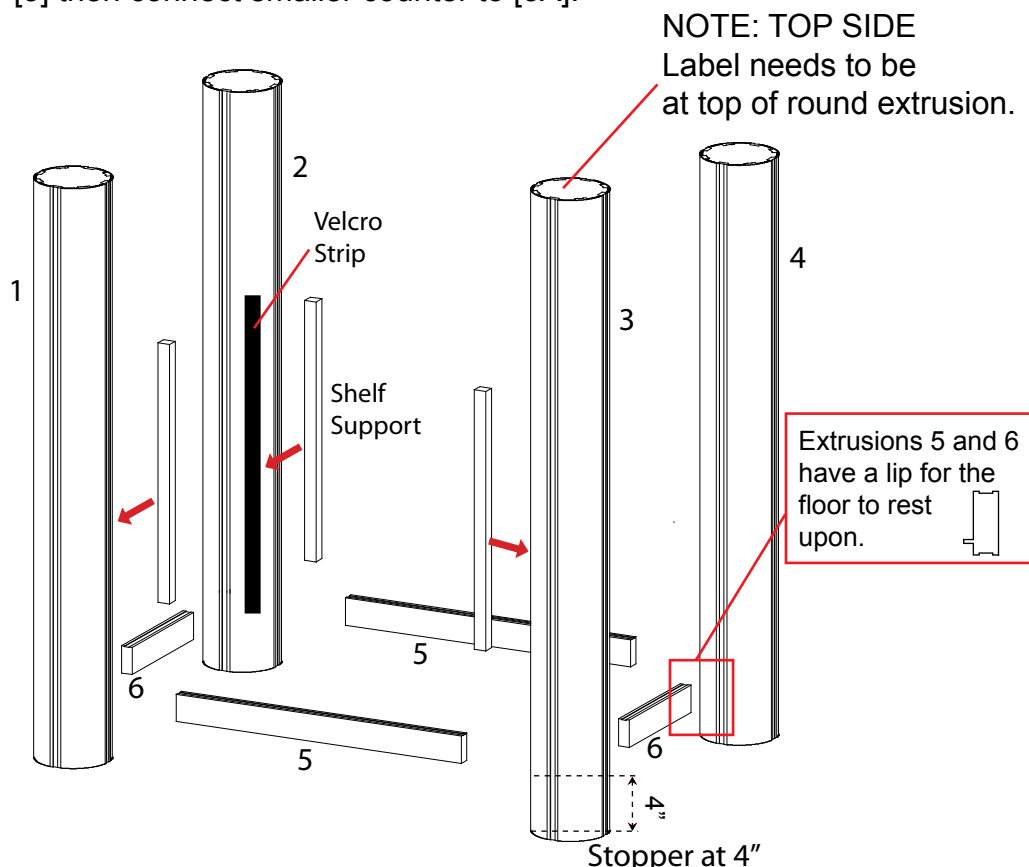
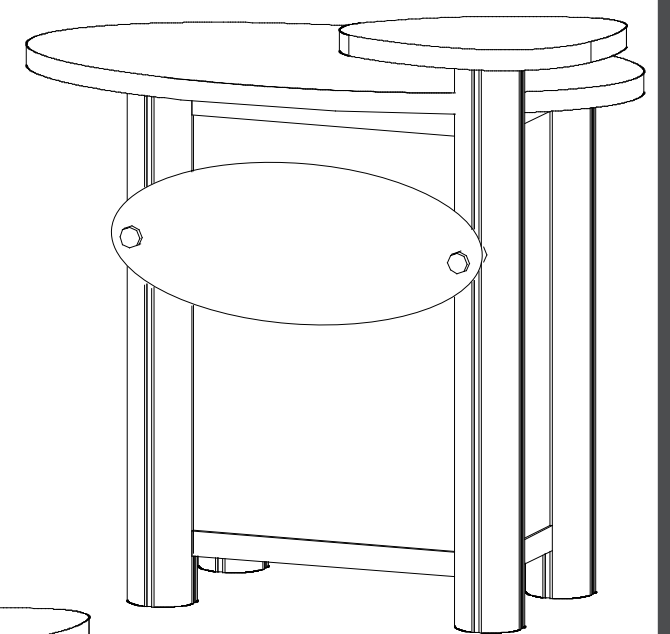
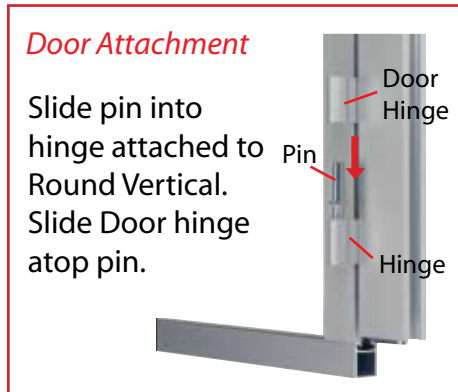

**WHEN DISASSEMBLING ALUMINUM EXTRUSION, TIGHTEN ALL SETSCREWS AND LOCKS TO PREVENT LOSS DURING SHIPPING**

# visionary™ IDESIGNS

## Using Your Setup Instructions

The Visionary Designs Setup Instructions are created specifically for your configuration. They are laid out sequentially, including an exploded view of the entire display, and then a logical series of detailed steps to assemble the main structure and components. We encourage you to study the instructions **before** attempting to assemble your exhibit.

Each page reminds you to tighten the setscrews after disassembling your exhibit to prevent loss of the locks and setscrews (see below in RED). This is VERY IMPORTANT.

## Cleaning and Packing Your Display

- 1) Use care when cleaning aluminum extrusion or acrylic inserts. Use only non-abrasive cleaners.
- 2) When cleaning laminate inserts or countertops, use mild cleansers and a soft material such as cotton.
- 3) Keep all display components away from extreme heat and long exposure to sunlight to avoid warping and fading.
- 4) Retain all packing material. It will make re-packing much easier and will reduce the likelihood of shipping damage.



The Tool

Most Visionary Designs exhibits can be assembled with the supplied Hex Key Tool. Occasionally, a flat head screwdriver may be required.



Detail A

Typical Connection



Typical Connection (cont'd)

Most horizontal extrusion connections have a patented expandable lock. This lock inserts into the groove of an opposing extrusion. Tightening the lock with the Hex Key Tool expands the lock and creates a strong positive connection.

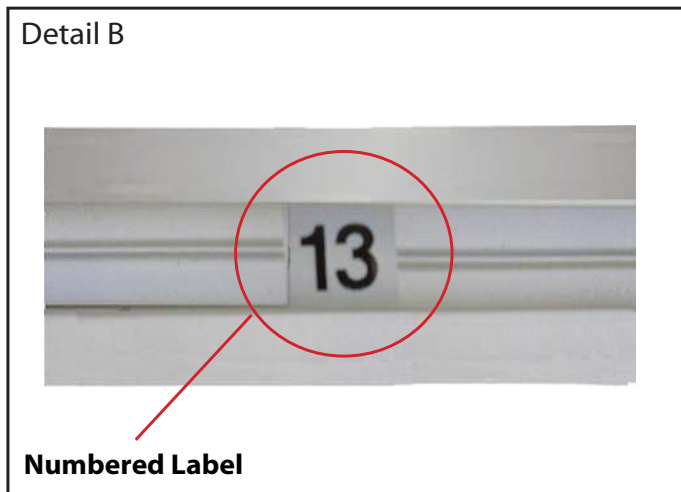

Detail B

Numbered Label

Each extrusion contains a numbered label which corresponds with setup instructions. The label is located within a groove of the extrusion (when possible). With Visionary Designs the labels contain Black numbers unless otherwise specified.



Detail C

Horizontal Inline Connection (remove only one setscrew)

Remove only (1) setscrew when disassembling. Replace setscrew in extrusion after assembling it. Before packing, replace setscrew in extrusion to avoid losing it.

**NOTE :**

PDF copies of your Setup Instructions are available @ [www.classicexhibits.com](http://www.classicexhibits.com)  
 Use the Search Tool located on the lower left-hand corner of the Classic Hon  
 Enter your 5-7 digit Order #.

Search for Setup Instructions

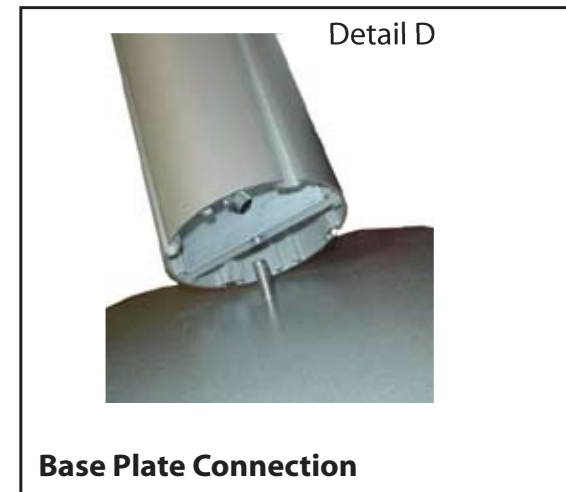

Detail D

Base Plate Connection

Attach base plate to round or square vertical extrusion using the bolt provided. Be careful not to strip the threads.

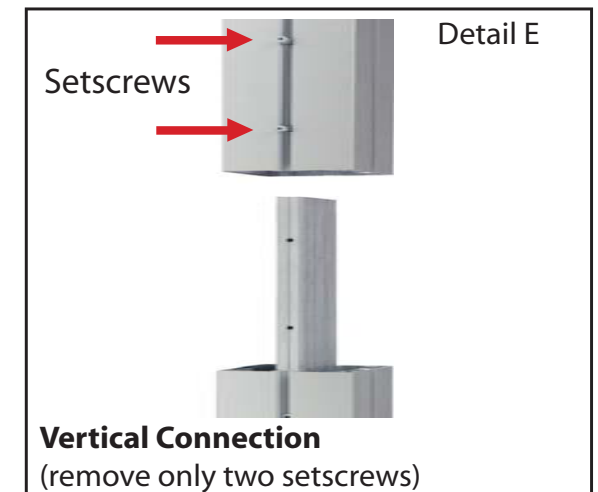

Detail E

Vertical Connection (remove only two setscrews)

When vertical extrusions are packed in portable cases rather than crates or tubs, they must be broken down into smaller sections which then require assembly.

Remove only (2) setscrews when disassembling. Replace setscrews in extrusion after assembling it. Before packing, replace setscrews in extrusion to avoid losing them.

**WHEN DISASSEMBLING ALUMINUM EXTRUSION, TIGHTEN ALL SETSCREWS AND LOCKS TO PREVENT LOSS DURING SHIPPING**

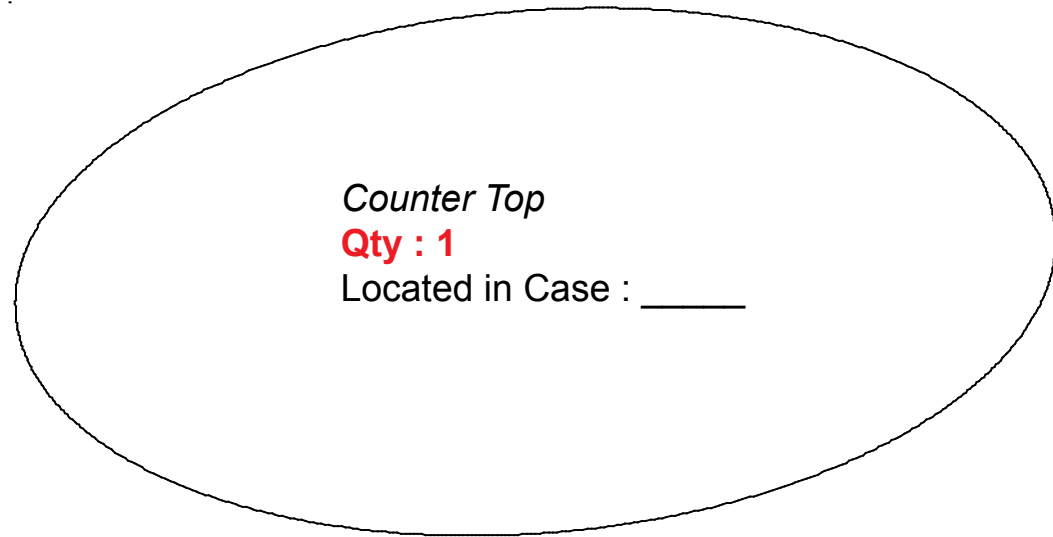

Counter Top  
Qty : 1  
Located in Case : \_\_\_\_\_

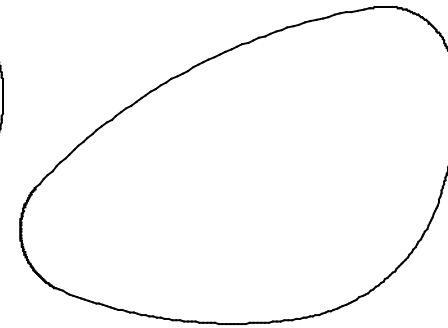

Small Counter Top  
Qty : 1  
Located in Case : \_\_\_\_\_

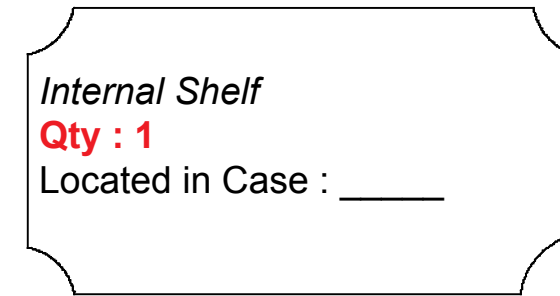

Internal Shelf  
Qty : 1  
Located in Case : \_\_\_\_\_

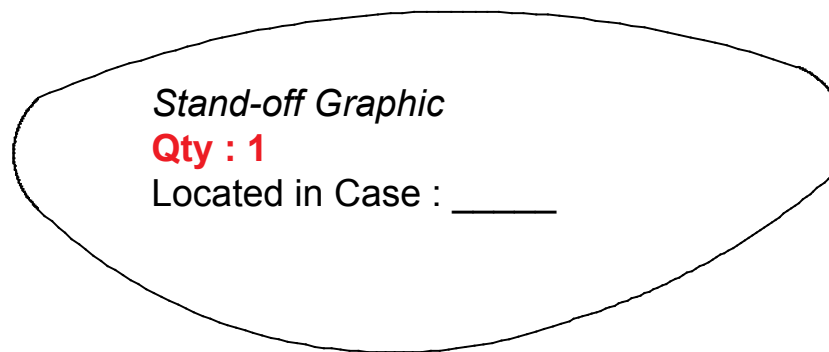

Stand-off Graphic  
Qty : 1  
Located in Case : \_\_\_\_\_

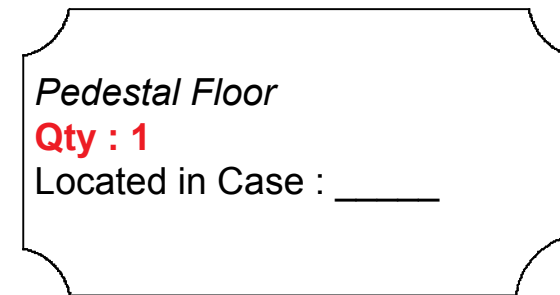

Pedestal Floor  
Qty : 1  
Located in Case : \_\_\_\_\_

 Flange  
Qty : 1  
Located in Case : \_\_\_\_\_

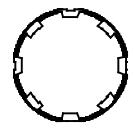
 38" h Round Vertical  
Qty : 1  
Located in Case : \_\_\_\_\_

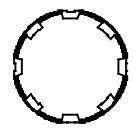
 42" h Round Vertical  
Qty : 1  
Located in Case : \_\_\_\_\_

 8.5" h Extrusion  
Qty : 4  
Located in Case : \_\_\_\_\_

 20" Extrusion  
Qty : 4  
Located in Case : \_\_\_\_\_

 Stand-offs and Caps  
Qty : 2  
Located in Case : \_\_\_\_\_

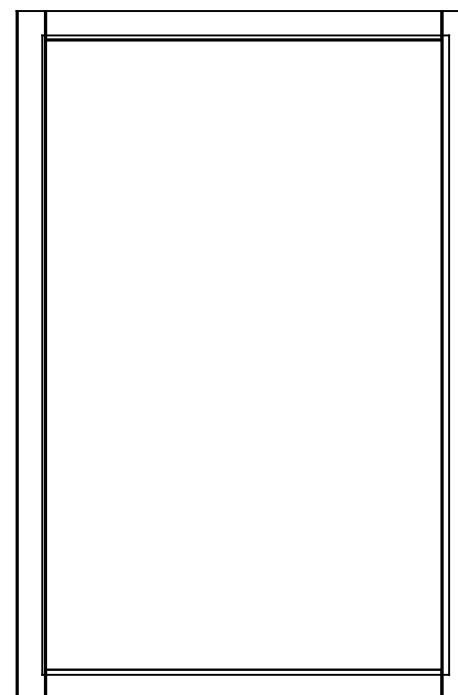

Locking Door  
Qty : 1  
Located in Case : \_\_\_\_\_



20.4375" w x 30.3343" h Insert  
Qty : 2  
Located in Case : \_\_\_\_\_

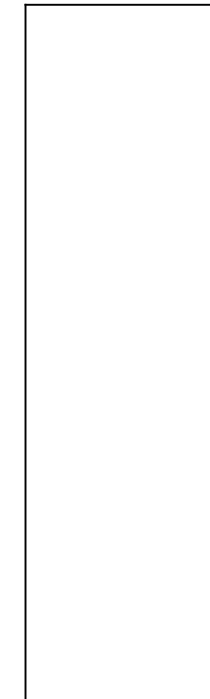

8.9375" w x 30.3343" h Insert  
Qty : 2  
Located in Case : \_\_\_\_\_

Additional Accessories:

Hex Key set

\_\_\_\_\_

\_\_\_\_\_

\_\_\_\_\_

\_\_\_\_\_

\_\_\_\_\_

Located in Case : \_\_\_\_\_

WHEN DISASSEMBLING ALUMINUM EXTRUSION, TIGHTEN ALL SETSCREWS AND LOCKS TO PREVENT LOSS DURING SHIPPING

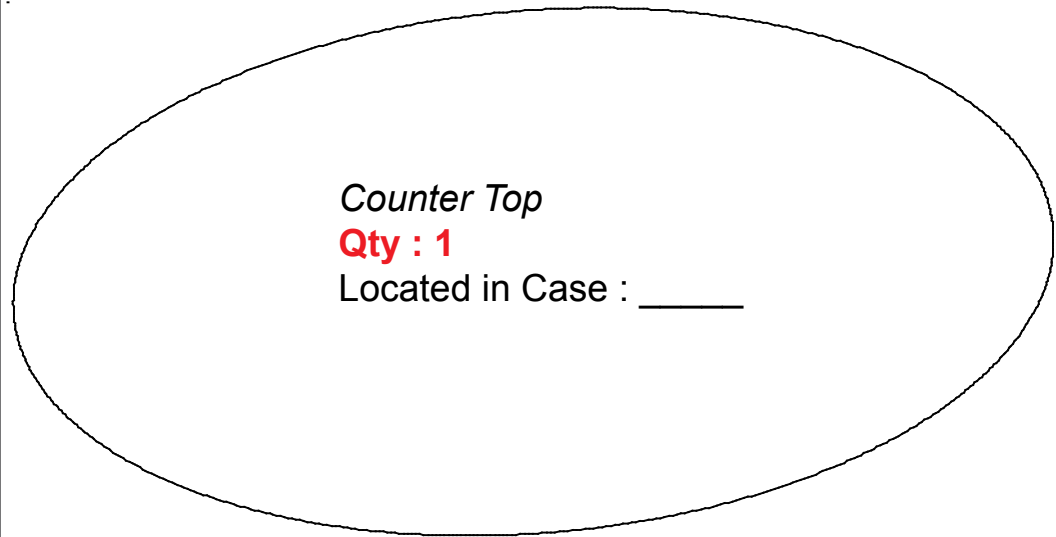

Counter Top  
Qty : 1  
Located in Case : \_\_\_\_\_

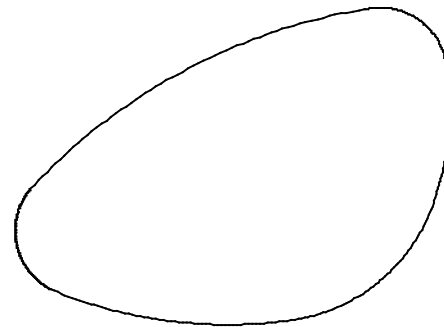

Small Counter Top  
Qty : 1  
Located in Case : \_\_\_\_\_

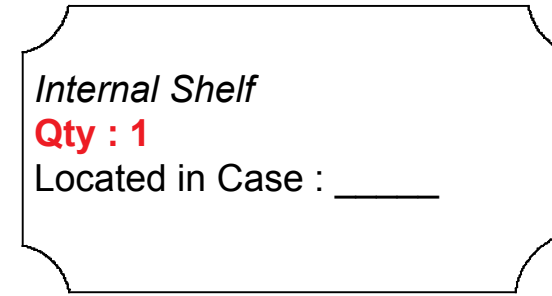

Internal Shelf  
Qty : 1  
Located in Case : \_\_\_\_\_

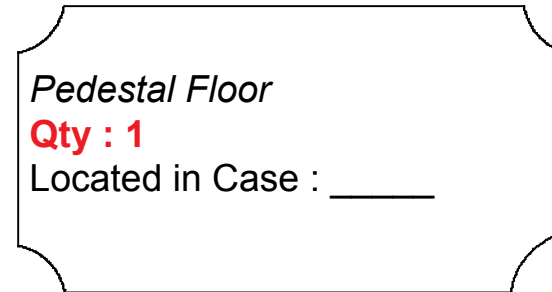

Pedestal Floor  
Qty : 1  
Located in Case : \_\_\_\_\_

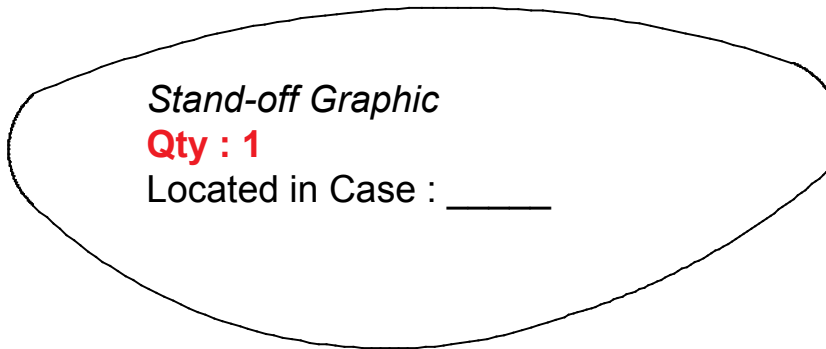

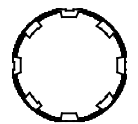

Stand-off Graphic  
Qty : 1  
Located in Case : \_\_\_\_\_

 Flange  
Qty : 1  
Located in Case : \_\_\_\_\_

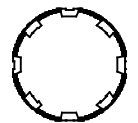
 38" h Round Vertical  
Qty : 1  
Located in Case : \_\_\_\_\_

 42" h Round Vertical  
Qty : 1  
Located in Case : \_\_\_\_\_

 8.5" h Extrusion  
Qty : 4  
Located in Case : \_\_\_\_\_

 20" Extrusion  
Qty : 4  
Located in Case : \_\_\_\_\_

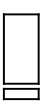
 Stand-offs and Caps  
Qty : 2  
Located in Case : \_\_\_\_\_

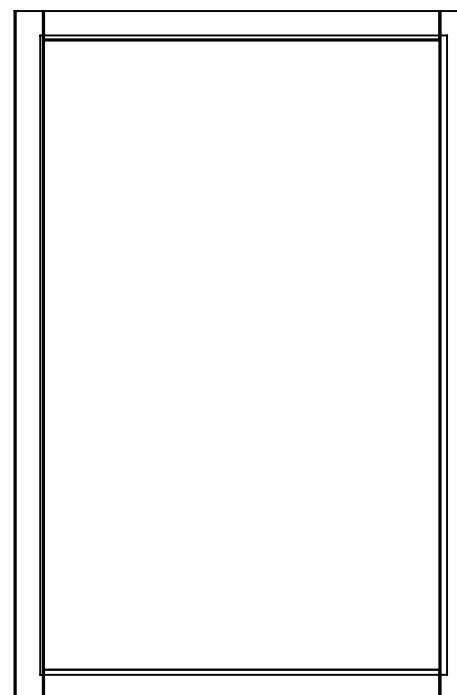

Locking Door  
Qty : 1  
Located in Case : \_\_\_\_\_



20.4375" w x 30.3343" h Insert  
Qty : 2  
Located in Case : \_\_\_\_\_

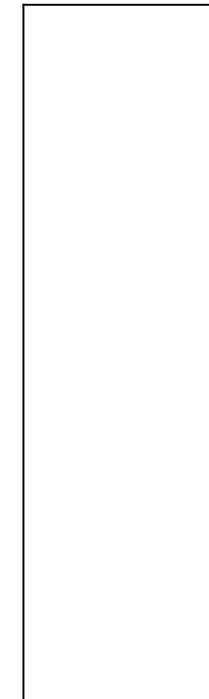

8.9375" w x 30.3343" h Insert  
Qty : 2  
Located in Case : \_\_\_\_\_

Additional Accessories:

Hex Key set

\_\_\_\_\_

\_\_\_\_\_

\_\_\_\_\_

\_\_\_\_\_

\_\_\_\_\_

Located in Case : \_\_\_\_\_

WHEN DISASSEMBLING ALUMINUM EXTRUSION, TIGHTEN ALL SETSCREWS AND LOCKS TO PREVENT LOSS DURING SHIPPING