

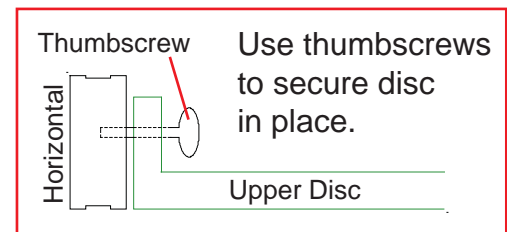

Item	Qty.	Description
1	1	84" h Vertical Extrusion
2	1	84" h Vertical Extrusion
3	1	45.3189" Curve Horizontal Extrusion
4	1	45.3189" Curve Horizontal Extrusion
5	1	45.3189" Curve Horizontal Extrusion
6	1	45.3189" Curve Horizontal Extrusion
7	1	45.3189" Curve Horizontal Extrusion
8	1	45.3189" Curve Horizontal Extrusion
9	1	45.3189" Curve Horizontal Extrusion
10	1	45.3189" Curve Horizontal Extrusion

Steps:

- 1) Attach curve horizontal extrusions [3, 4, 5 and 6] to vertical extrusions [1 and 2], placing insert panels where indicated.
- 2) Attach lower disc to extrusions [5 and 6] as shown.

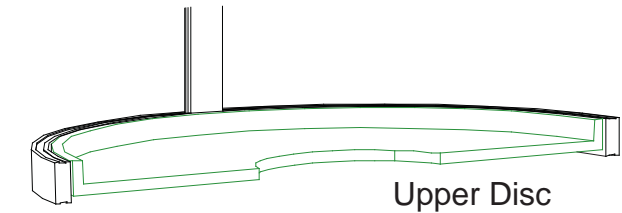
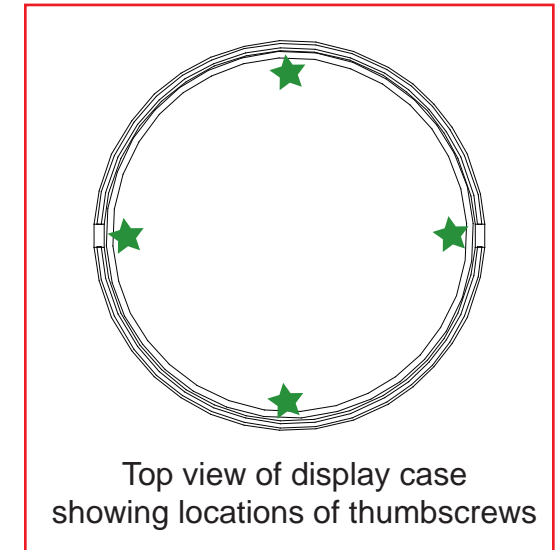
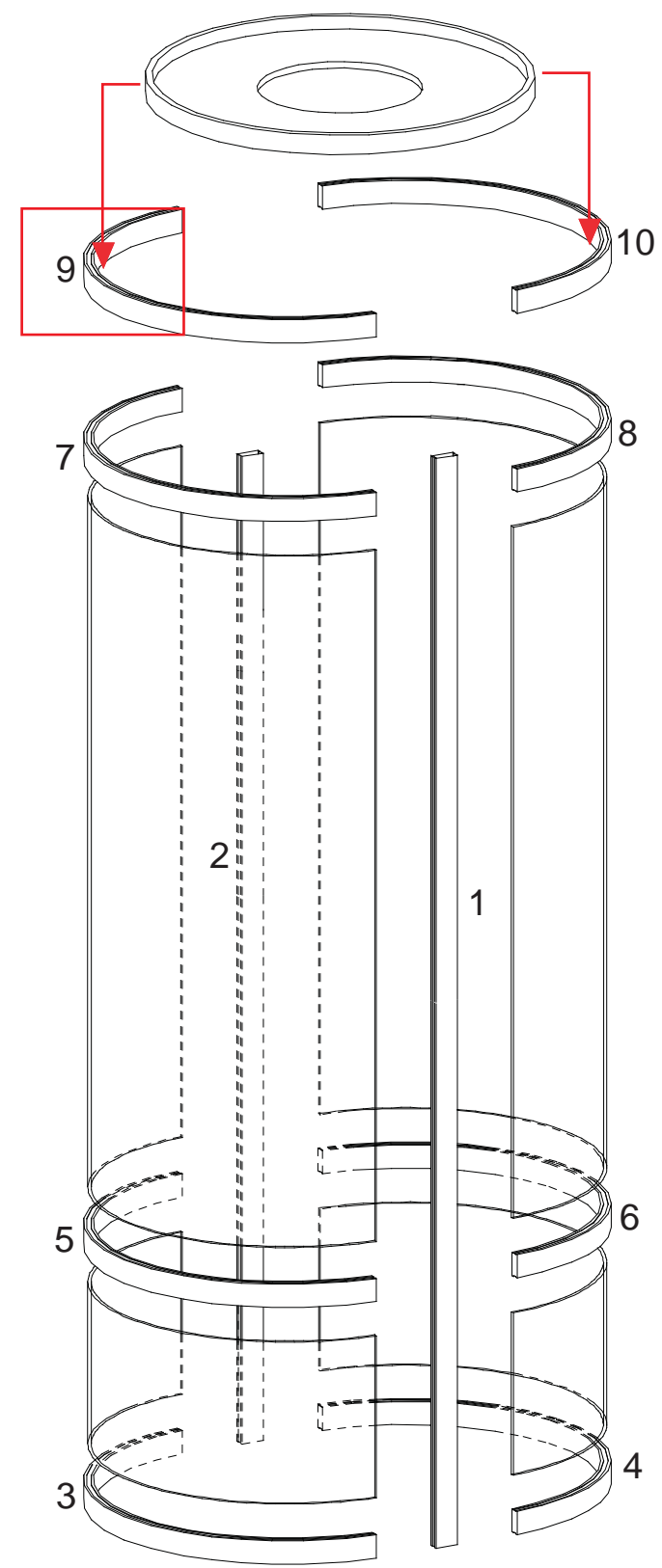
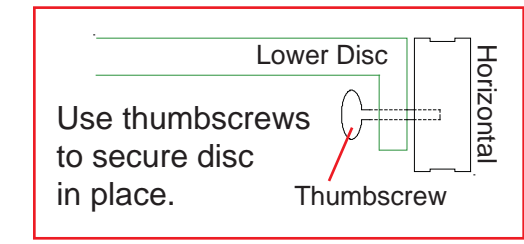
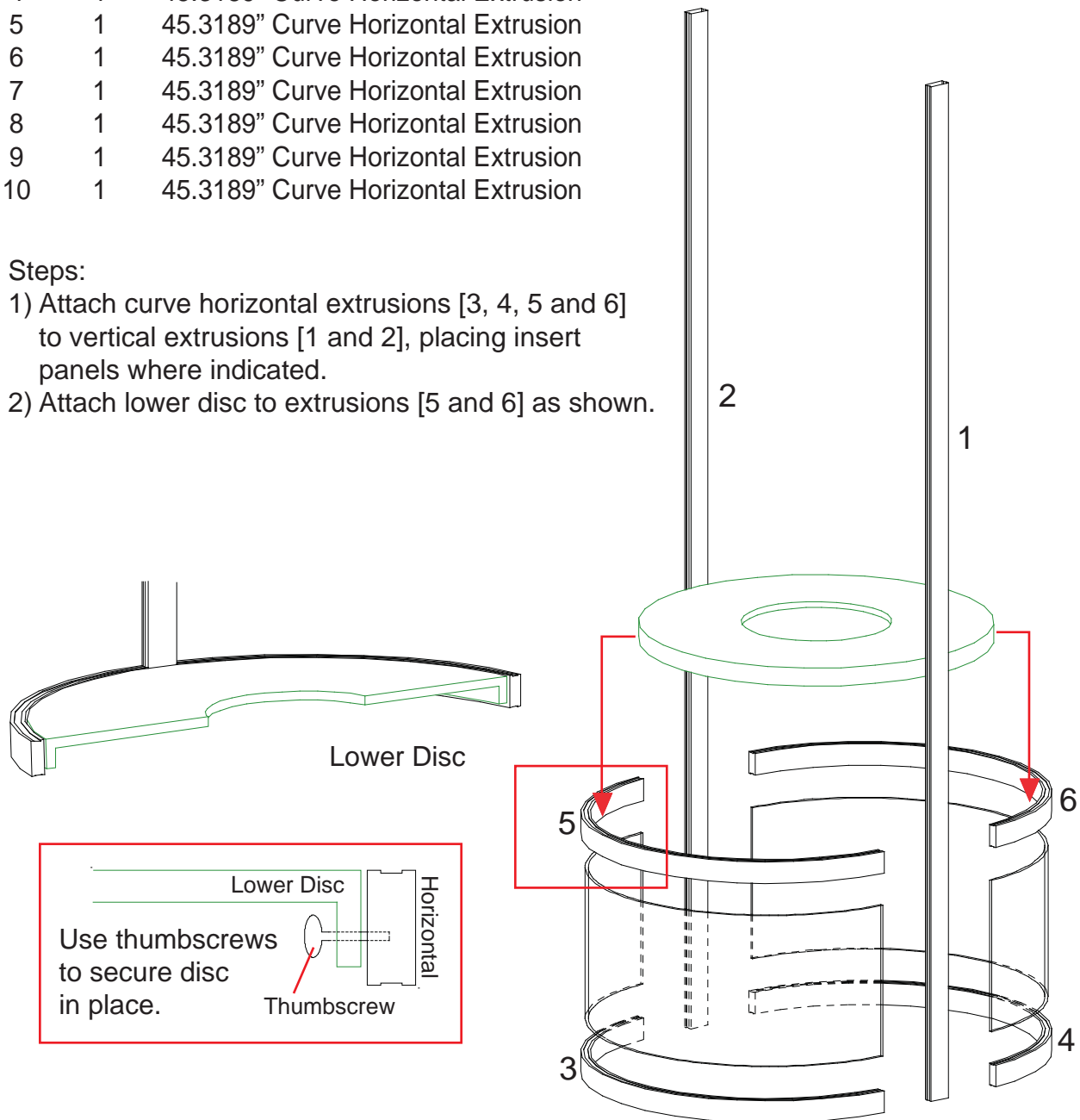

Steps:

- 3) After lower disc is in place, place insert panels atop horizontal extrusions [5 and 6].
 - 4) Attach horizontal extrusions [5 and 6] to vertical extrusions [1 and 2] and atop insert panels.
 - 5) Attach horizontal extrusions [9 and 10] to vertical extrusions [1 and 2].
- Note: Horizontals must be flush with top of verticals [1 and 2].*
- 6) Attach upper disc to horizontal extrusions [9 and 10] as shown.

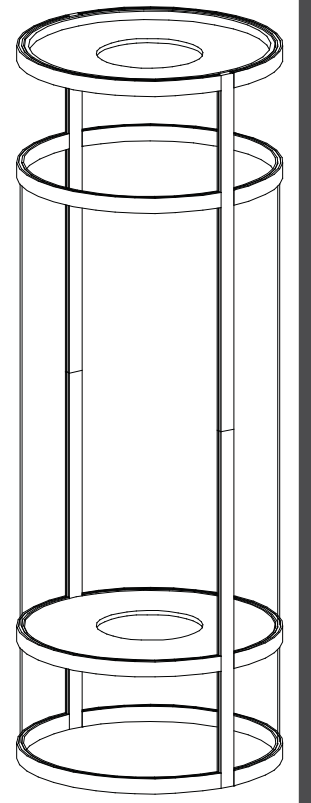

WHEN DISASSEMBLING ALUMINUM EXTRUSION, TIGHTEN ALL SETSCREWS AND LOCKS TO PREVENT LOSS DURING SHIPPING

visionary™ IDESIGNS

Using Your Setup Instructions

The Visionary Designs Setup Instructions are created specifically for your configuration. They are laid out sequentially, including an exploded view of the entire display, and then a logical series of detailed steps to assemble the main structure and components. We encourage you to study the instructions **before** attempting to assemble your exhibit.

Each page reminds you to tighten the setscrews after disassembling your exhibit to prevent loss of the locks and setscrews (see below in RED). This is **VERY IMPORTANT**.

Cleaning and Packing Your Display

- 1) Use care when cleaning aluminum extrusion or acrylic inserts. Use only non-abrasive cleaners.
- 2) When cleaning laminate inserts or countertops, use mild cleansers and a soft material such as cotton.
- 3) Keep all display components away from extreme heat and long exposure to sunlight to avoid warping and fading.
- 4) Retain all packing material. It will make re-packing much easier and will reduce the likelihood of shipping damage.



The Tool

Most Visionary Designs exhibits can be assembled with the supplied Hex Key Tool. Occasionally, a flat head screwdriver may be required.



Detail A

Typical Connection



Typical Connection (cont'd)

Most horizontal extrusion connections have a patented expandable lock. This lock inserts into the groove of an opposing extrusion. Tightening the lock with the Hex Key Tool expands the lock and creates a strong positive connection.

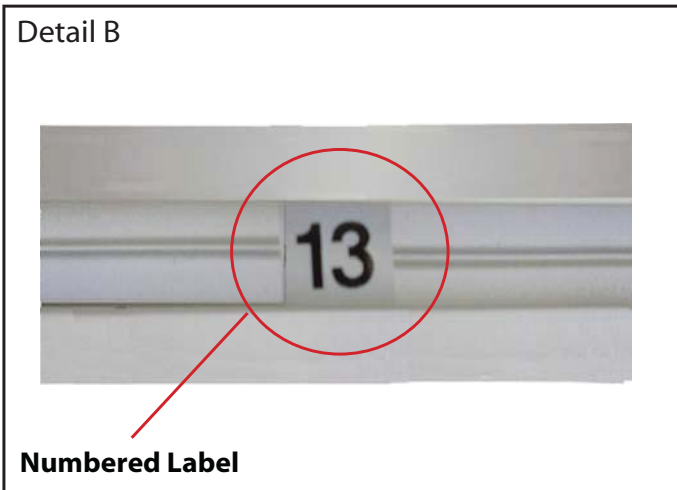

Detail B

Numbered Label

Each extrusion contains a numbered label which corresponds with setup instructions. The label is located within a groove of the extrusion (when possible). With Visionary Designs the labels contain Black numbers unless otherwise specified.



Detail C

Horizontal Inline Connection (remove only one setscrew)

Remove only (1) setscrew when disassembling. Replace setscrew in extrusion after assembling it. Before packing, replace setscrew in extrusion to avoid losing it.

NOTE :

PDF copies of your Setup Instructions are available @ www.classicexhibits.com
 Use the Search Tool located on the lower left-hand corner of the Classic Home page.
 Enter your 5-7 digit Order #.

Search for Setup Instructions

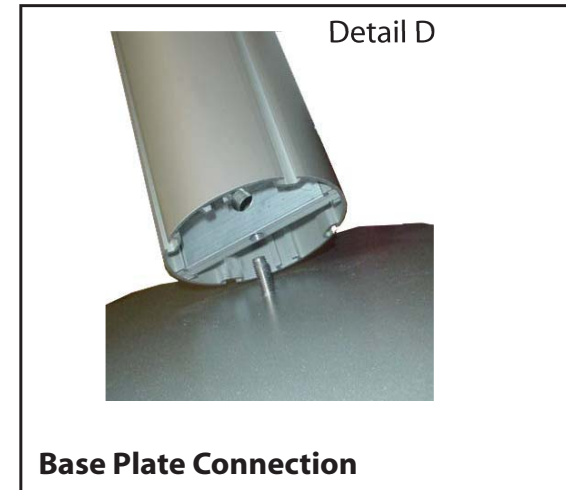

Detail D

Base Plate Connection

Attach base plate to round or square vertical extrusion using the bolt provided. Be careful not to strip the threads.

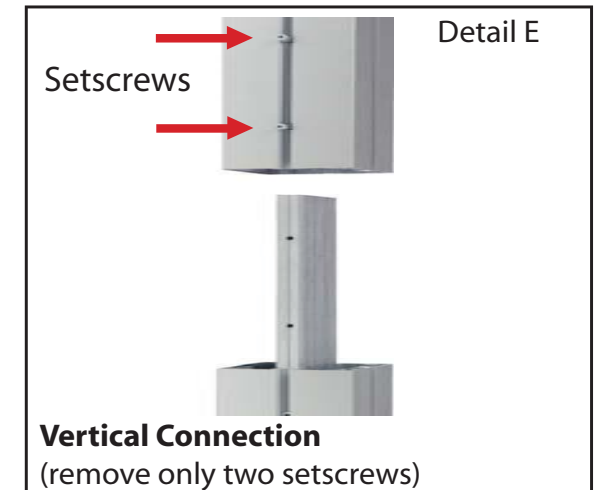

Detail E

Vertical Connection
(remove only two setscrews)

When vertical extrusions are packed in portable cases rather than crates or tubs, they must be broken down into smaller sections which then require assembly.

Remove only (2) setscrews when disassembling. Replace setscrews in extrusion after assembling it. Before packing, replace setscrews in extrusion to avoid losing them.

WHEN DISASSEMBLING ALUMINUM EXTRUSION, TIGHTEN ALL SETSCREWS AND LOCKS TO PREVENT LOSS DURING SHIPPING