

20'

10'

Plan View

WHEN DISASSEMBLING ALUMINUM EXTRUSION, TIGHTEN ALL SETSCREWS AND LOCKS TO PREVENT LOSS DURING SHIPPING

visionary™ IDESIGNS

Using Your Setup Instructions

The Visionary Designs Setup Instructions are created specifically for your configuration. They are laid out sequentially, including an exploded view of the entire display, and then a logical series of detailed steps to assemble the main structure and components. We encourage you to study the instructions **before** attempting to assemble your exhibit.

Each page reminds you to tighten the setscrews after disassembling your exhibit to prevent loss of the locks and setscrews (see below in RED). This is **VERY IMPORTANT**.

Cleaning and Packing Your Display

- 1) Use care when cleaning aluminum extrusion or acrylic inserts. Use only non-abrasive cleaners.
- 2) When cleaning laminate inserts or countertops, use mild cleansers and a soft material such as cotton.
- 3) Keep all display components away from extreme heat and long exposure to sunlight to avoid warping and fading.
- 4) Retain all packing material. It will make re-packing much easier and will reduce the likelihood of shipping damage.



The Tool

Most Visionary Designs exhibits can be assembled with the supplied Hex Key Tool. Occasionally, a flat head screwdriver may be required.



Detail A

Typical Connection



Typical Connection (cont'd)

Most horizontal extrusion connections have a patented expandable lock. This lock inserts into the groove of an opposing extrusion. Tightening the lock with the Hex Key Tool expands the lock and creates a strong positive connection.



Detail B

Numbered Label

Each extrusion contains a numbered label which corresponds with setup instructions. The label is located within a groove of the extrusion (when possible). With Visionary Designs the labels contain Black numbers unless otherwise specified.



Detail C

Horizontal Inline Connection (remove only one setscrew)

Remove only (1) setscrew when disassembling. Replace setscrew in extrusion after assembling it. Before packing, replace setscrew in extrusion to avoid losing it.

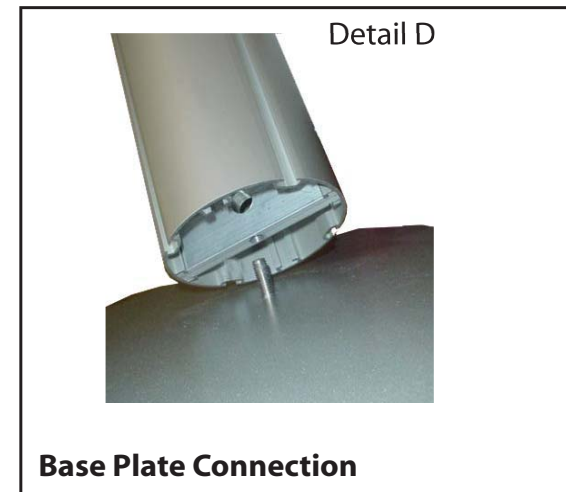

Detail D

Base Plate Connection

Attach base plate to round or square vertical extrusion using the bolt provided. Be careful not to strip the threads.



Detail E

Vertical Connection
(remove only two setscrews)

When vertical extrusions are packed in portable cases rather than crates or tubs, they must be broken down into smaller sections which then require assembly.

Remove only (2) setscrews when disassembling. Replace setscrews in extrusion after assembling it. Before packing, replace setscrews in extrusion to avoid losing them.

WHEN DISASSEMBLING ALUMINUM EXTRUSION, TIGHTEN ALL SETSCREWS AND LOCKS TO PREVENT LOSS DURING SHIPPING

Item	Qty.	Description
1	2	Base Plate
2	2	83.25"h Vertical Extrusion
3	1	83.5"h Vertical Extrusion w/ A10 Clamps Attached
3a	1	Hinge Extrusion
4	1	83.5"h Vertical Extrusion
4a	1	Hinge Extrusion
5/5a	1/1	86"w Horizontal Extrusion
6	1	33.918"h Vertical Extrusion
7	1	86"w Horizontal Extrusion
8	1	86"w Horizontal Extrusion
9	1	42.418"w Vertical Extrusion
10	1	42.418"w Vertical Extrusion
11	4	60.5"w Horizontal Extrusion

Steps:

- 1) Attach vertical extrusions [2] to base plates [1].
- 2) Attach horizontal extrusions [11] between vertical extrusions [2&3a and 2&4a], placing inserts between horizontal bars.
- Note: Hinges [3a and 4a] must face forward.*
- 3) Attach horizontal lower horizontal extrusion [5] between vertical extrusions [3 and 4].
- 4) Attach vertical extrusion [6] to horizontal extrusion [5], leave loose.
- 5) Place laminated inserts between vertical extrusions, then tighten vertical extrusion [6].
- 6) Attach horizontal extrusion [5] between vertical extrusions [3 and 4] and atop vertical extrusion [6].
- 7) Attach horizontal extrusion [7] between vertical extrusions [3 and 4] and atop horizontal extrusion [5].
- 8) Attach vertical extrusions [8 and 9] to left and right end of horizontal extrusion [7].
- 9) Attach horizontal extrusion [10] between vertical extrusions [3 and 4] and atop vertical extrusion [8 and 9].

NOTE: Hinge Extrusion [3a and 4a] must stay attached to vertical extrusions.

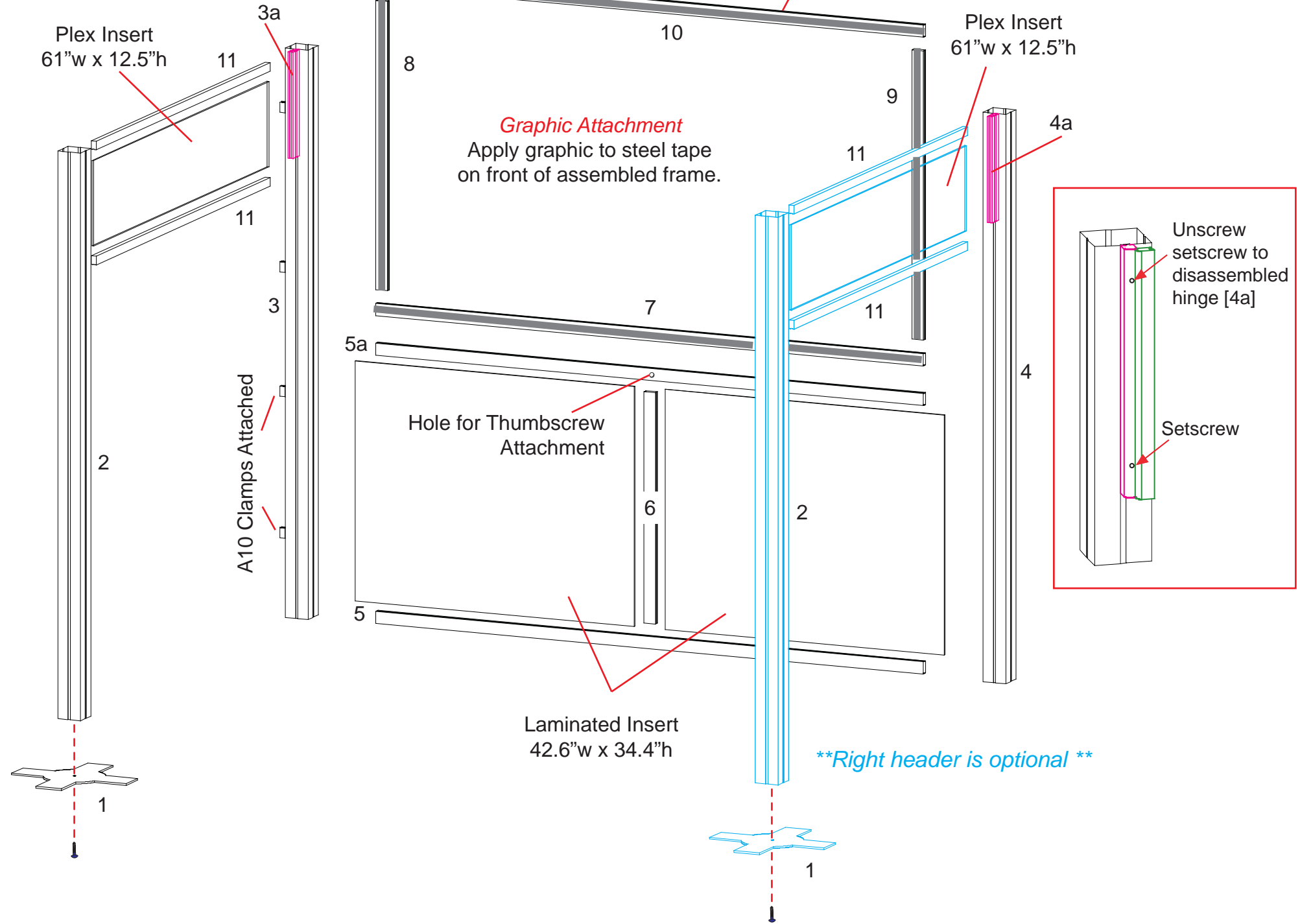

WHEN DISASSEMBLING ALUMINUM EXTRUSION, TIGHTEN ALL SETSCREWS AND LOCKS TO PREVENT LOSS DURING SHIPPING

Item	Qty.	Description
12	1	37" h 90° Corner Extrusion w/ Door Stop
13	1	37" h 90° Corner Extrusion w/ Door Hinges
14	4	12" w Horizontal Extrusion
15	2	87.79" w Horizontal Extrusion
16	1	33.42" h Vertical Extrusion w/ Door Hinges
17	1	33.42" h Vertical Extrusion w/ Door Stop
18	1	33.42" h Vertical Extrusion w/ Door Hinges
19	1	33.42" h Vertical Extrusion w/ Door Stop

Steps:

- 1) Connect horizontal extrusions [14] between vertical extrusions [3 and 12], placing inserts where indicated.
 - 2) Connect lower horizontal extrusion [15] between vertical extrusions [12 and 13].
 - 3) Attach vertical extrusions [16, 17, 18 and 19] to horizontal bar [15], placing inserts and attaching doors where indicated.
- Note: See illustration for extrusion orientation*
- 4) Connect upper horizontal extrusion [15] between vertical extrusions [12 and 13] and atop verticals, doors and inserts.

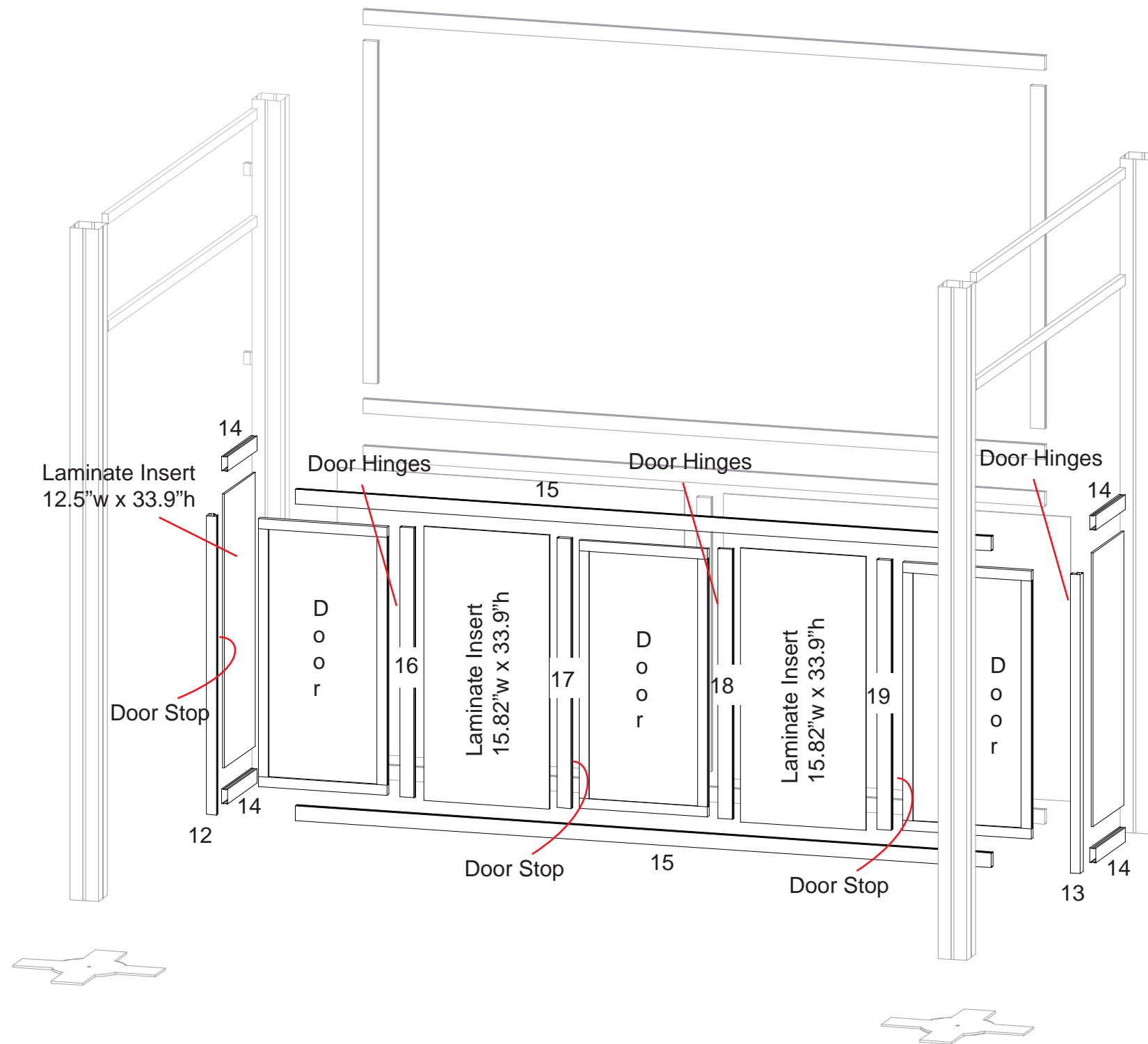

WHEN DISASSEMBLING ALUMINUM EXTRUSION, TIGHTEN ALL SETSCREWS AND LOCKS TO PREVENT LOSS DURING SHIPPING

Ceiling Assembly

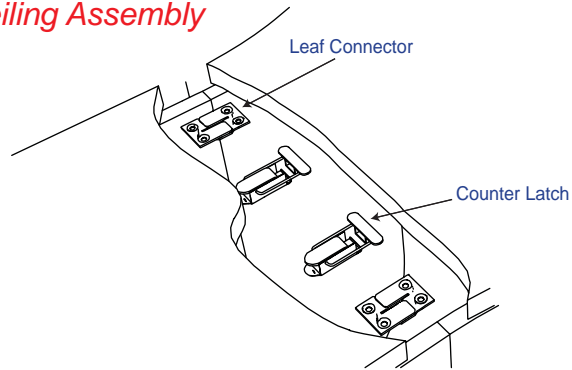

Leaf Connector
Counter Latch

Slide ceiling pieces together until leaf connectors engage. Then secure latches

A10 Clamp Attachment
If get disassembled

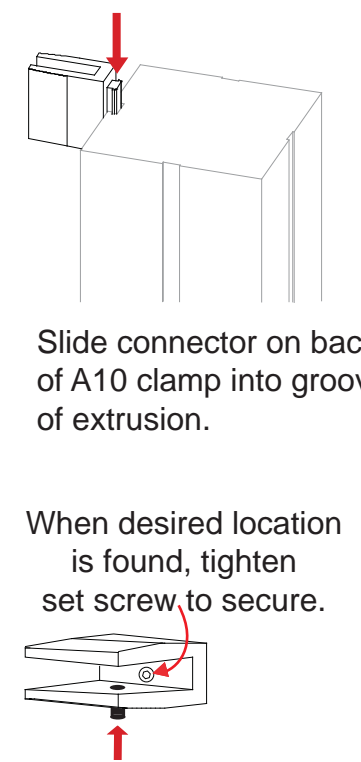

Slide connector on back of A10 clamp into groove of extrusion.

When desired location is found, tighten set screw to secure.

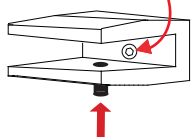

Tighten black plastic set screw to secure panel in place.

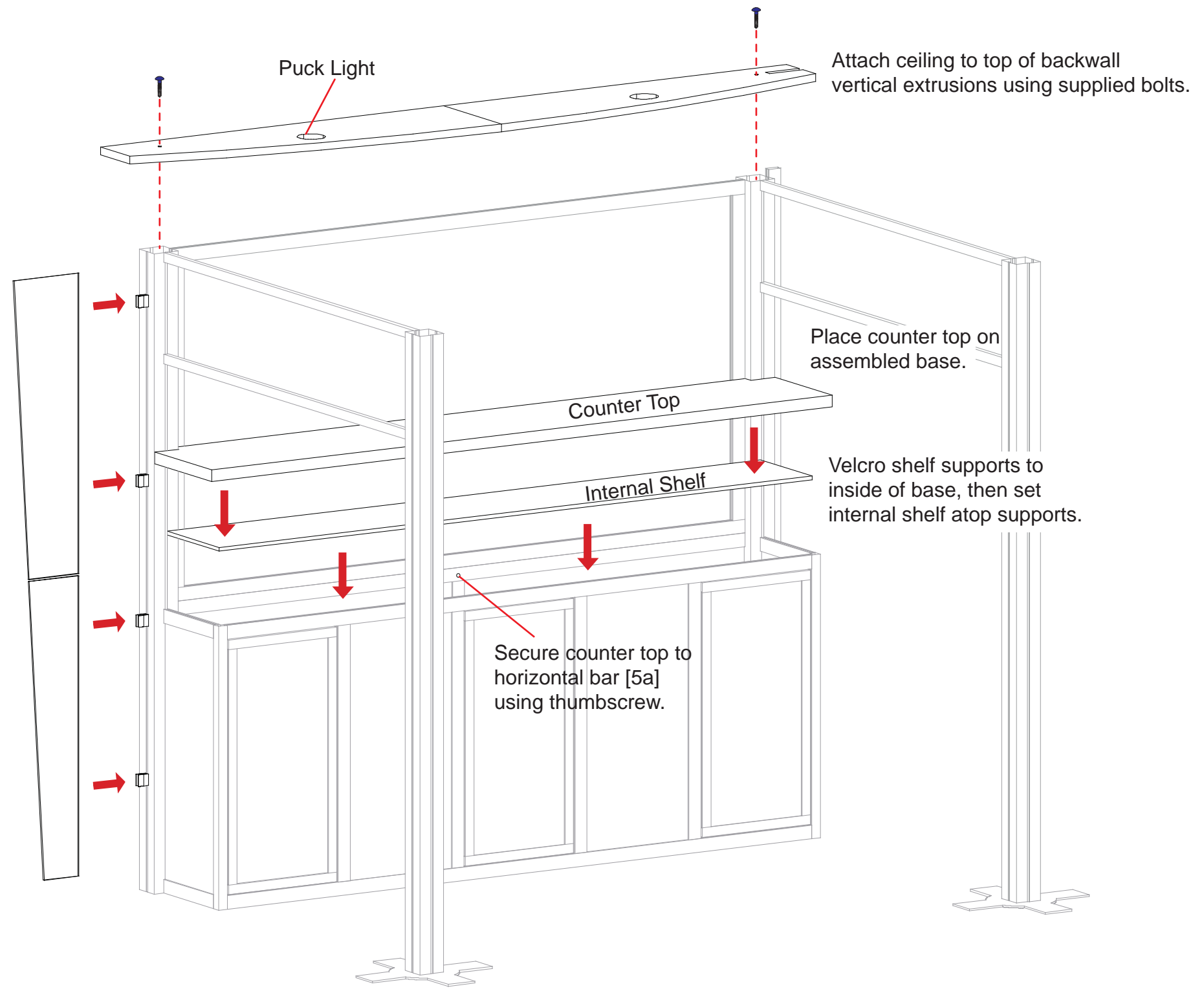

Puck Light

Attach ceiling to top of backwall vertical extrusions using supplied bolts.

Place counter top on assembled base.

Counter Top

Internal Shelf

Velcro shelf supports to inside of base, then set internal shelf atop supports.

Secure counter top to horizontal bar [5a] using thumbscrew.

WHEN DISASSEMBLING ALUMINUM EXTRUSION, TIGHTEN ALL SETSCREWS AND LOCKS TO PREVENT LOSS DURING SHIPPING

Attach light reflector panels to back of assembled graphic frame.

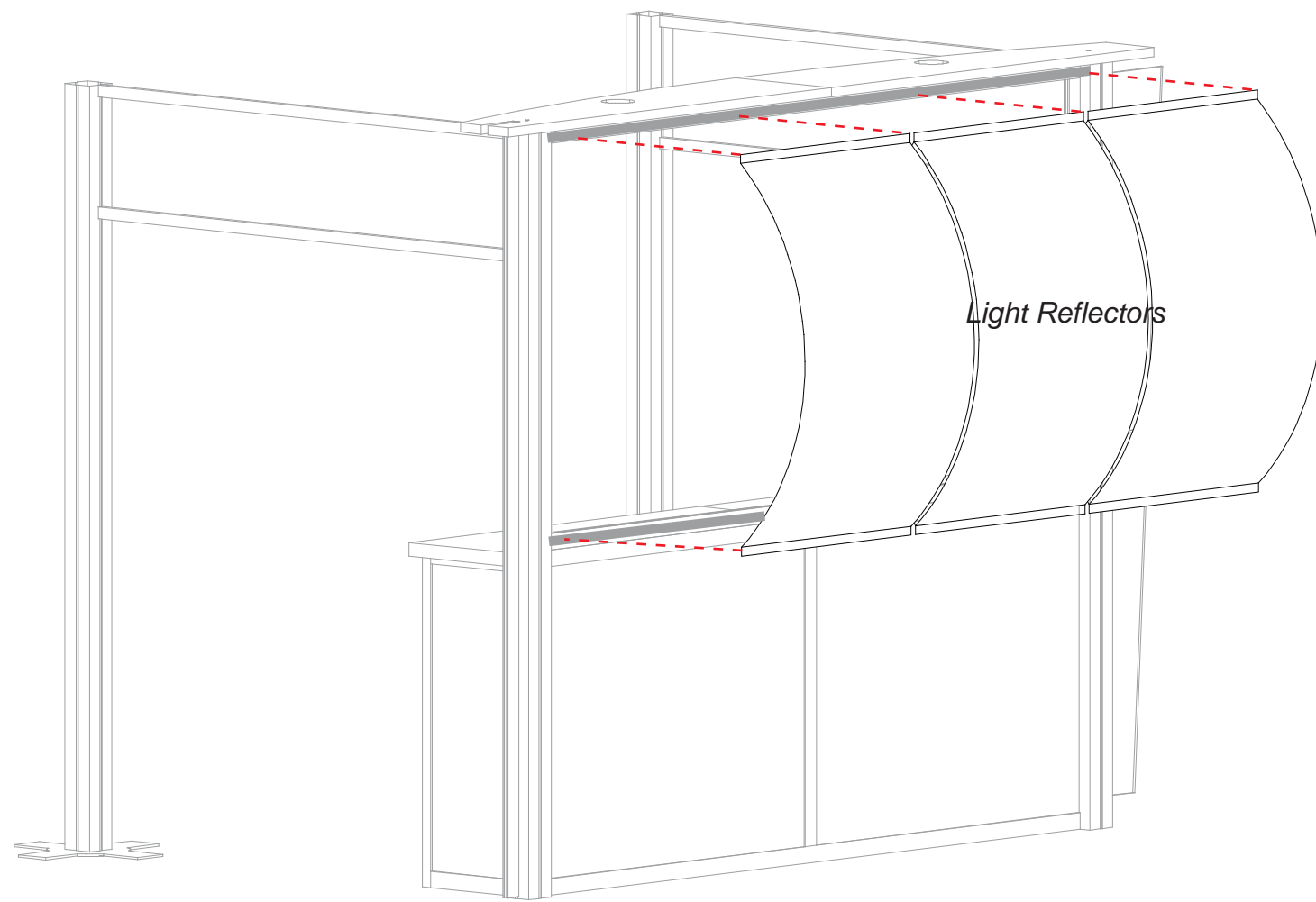

Back Side of Assembled Backwall

Velcro fluorescent lights to Velcro strips on front of reflector panels.

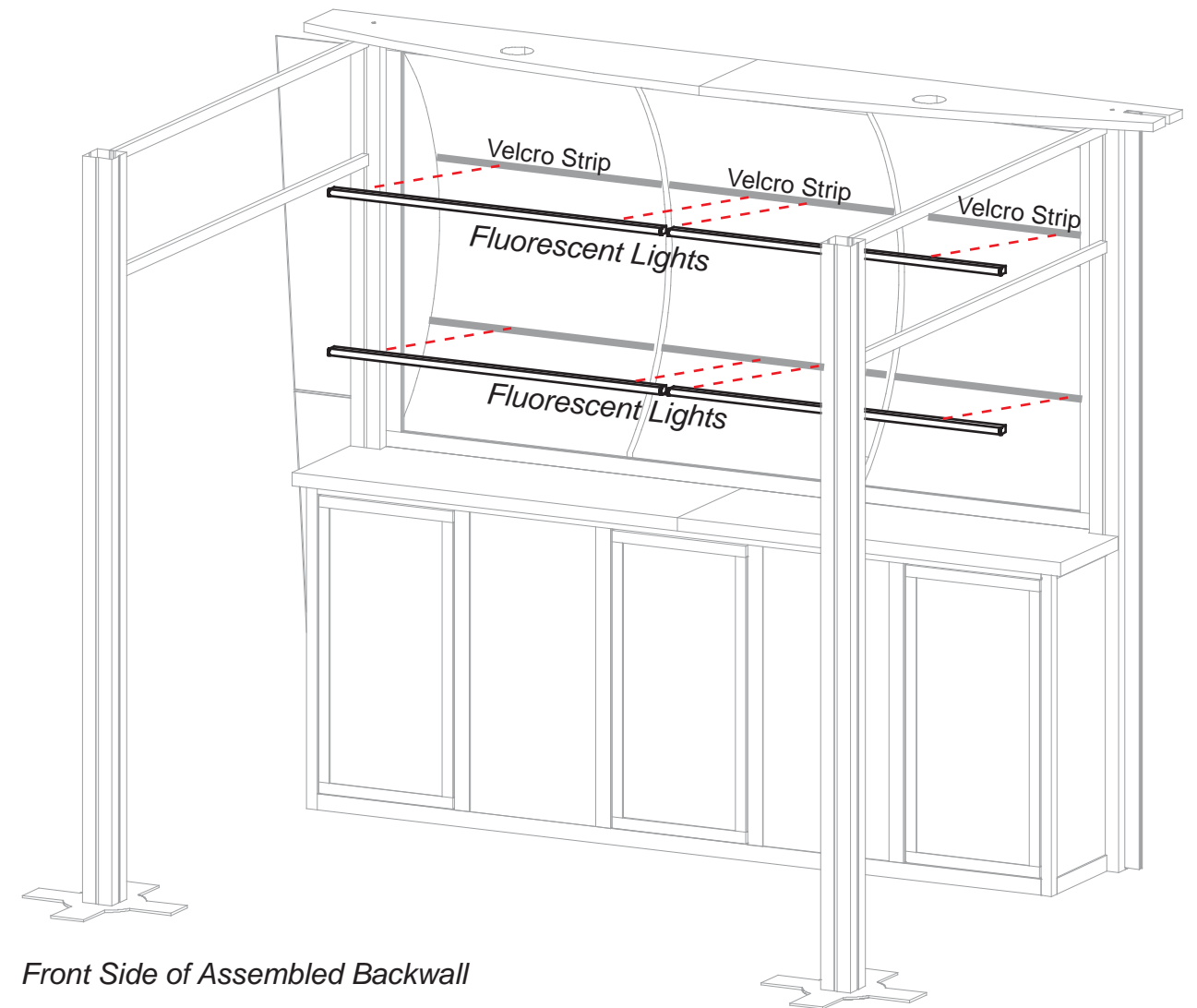

Front Side of Assembled Backwall

WHEN DISASSEMBLING ALUMINUM EXTRUSION, TIGHTEN ALL SETSCREWS AND LOCKS TO PREVENT LOSS DURING SHIPPING

Item	Qty.	Description
20	1	Base Plate
21	1	46.979"h Vertical Extrusion
22	1	46.979"h Vertical Extrusion
23	1	46.979"h Vertical Extrusion
24	1	46.979"h Vertical Extrusion
25	1	46.979"h Vertical Extrusion
26	1	46.979"h Vertical Extrusion
27	1	79.63"h Vertical Extrusion
28	6	40.223"w Horizontal Extrusion
29a/29b	1/1	47.48"w Horizontal Extrusion
30a/30b	1/1	Horizontal Extrusion
30c	1	Horizontal Extrusion
31	1	7.917"h Vertical Extrusion
31a	2	10" Vertical Extrusion

Steps:

Note: Unit can be assembled lying down on the floor then lifted upright as shown in drawings.

- 1) Connect vertical extrusions [21 to 22, 23 to 24 and 25 to 26] together.
- 2) Connect horizontal extrusions [29a to 29b and 30a to 30b to 30c] together.
- 3) Connect horizontal extrusions [28] between vertical assemblies and vertical extrusion [27].
- 4) Attach one end of horizontal assembly [29a/29b] to top of extrusion [27].
- 5) Connect vertical extrusions [31 and 31a] between horizontal assemblies [29a/29b] and [30a/30b/30c], then secure the other end of [30a/30b/30c] to top of extrusion [22].

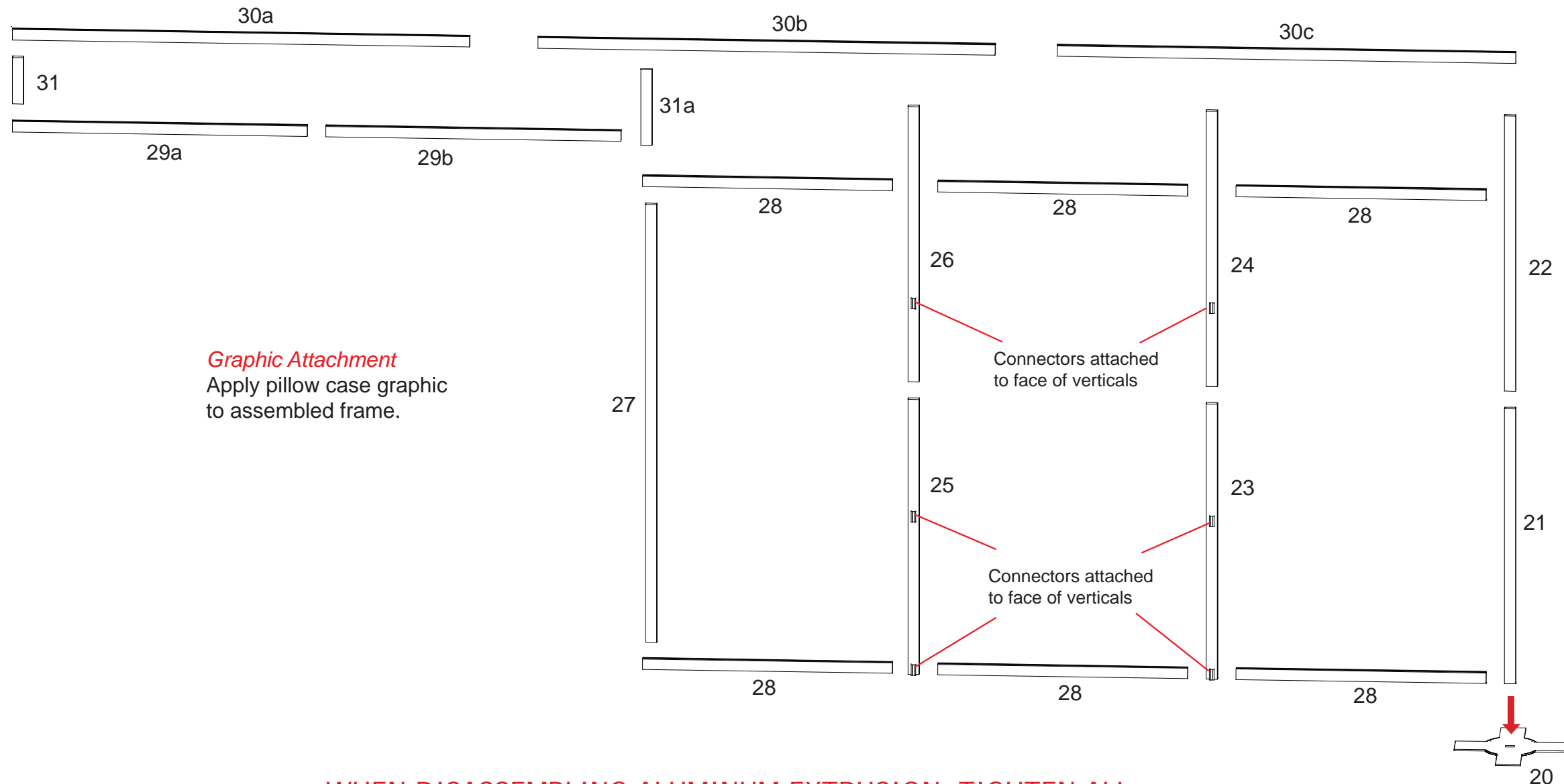

Graphic Attachment
Apply pillow case graphic to assembled frame.

WHEN DISASSEMBLING ALUMINUM EXTRUSION, TIGHTEN ALL SETSCREWS AND LOCKS TO PREVENT LOSS DURING SHIPPING

Item	Qty.	Description
32	2	Base Plate
33	1	84.08"h Vertical Extrusion
34	1	64.3"h Vertical Extrusion
35a/35b	1/1	46.89"w Horizontal Extrusion
36a/36b	1/1	46.89"w Horizontal Extrusion
37a/37b	1/1	46.89"w Horizontal Extrusion
38a/38b	1/1	48.32"w Curved Horizontal Extrusion

Steps:

Note: Unit can be assembled lying down on the floor then lifted upright as shown in drawings.

- 1) Connect horizontal extrusions [35a to 35b, 36a to 36b, 37a to 37b and 38a to 38b] together.
- 2) Attach vertical extrusions [33 and 34] to base plates [32].
- 3) Attach horizontal assemblies between vertical extrusions as shown.

Graphic Attachment

Apply pillow case graphic to assembled frame.

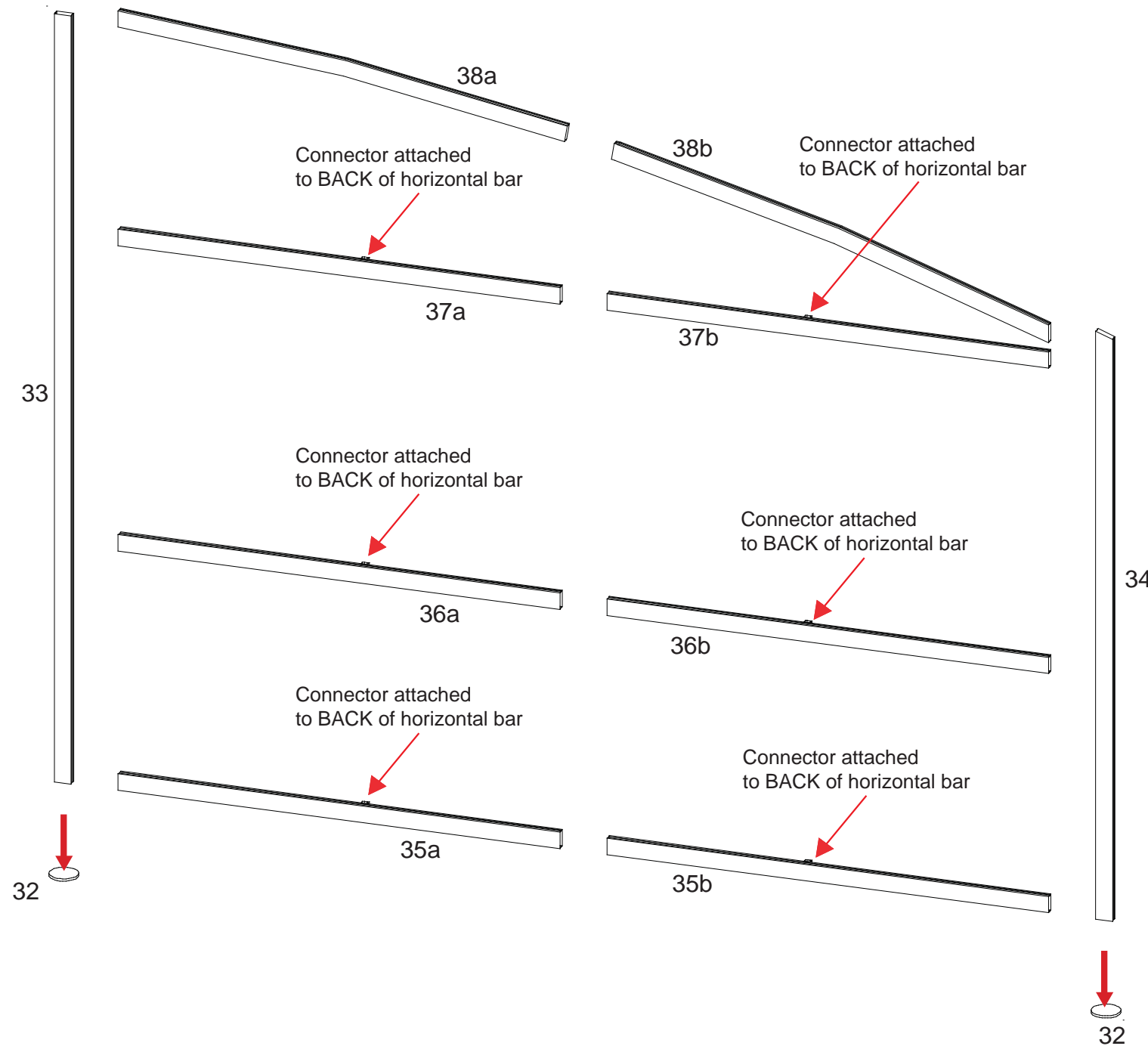

WHEN DISASSEMBLING ALUMINUM EXTRUSION, TIGHTEN ALL SETSCREWS AND LOCKS TO PREVENT LOSS DURING SHIPPING

866.652.2100

Item	Qty.	Description
39	6	4" Extrusion Connector

- Steps:
- 1) Attach assembled frame to assembled left section by locking horizontal bars [28] to square vertical [4].
 - 2) Attach extrusions [39] to connectors on front of frame.

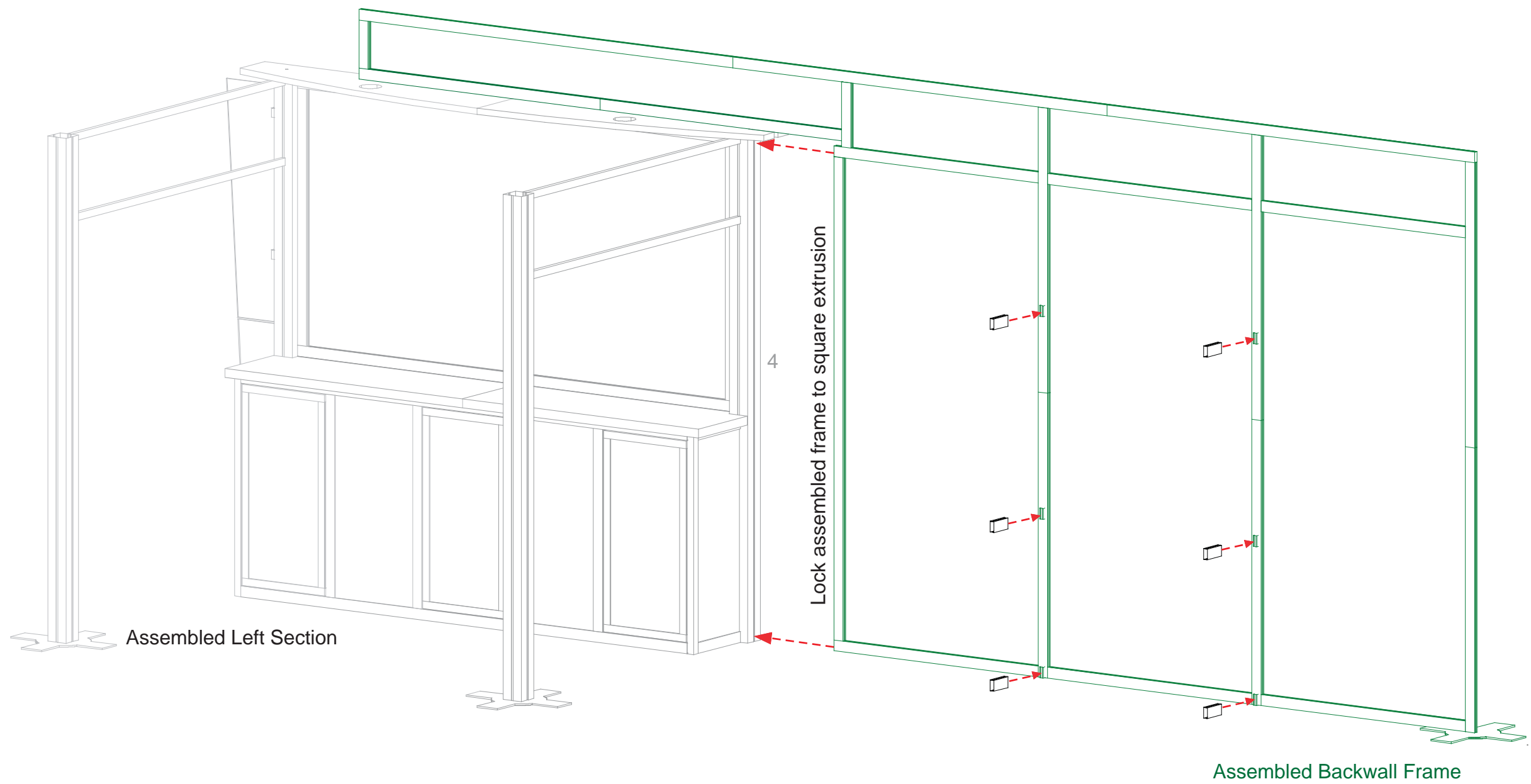

WHEN DISASSEMBLING ALUMINUM EXTRUSION, TIGHTEN ALL SETSCREWS AND LOCKS TO PREVENT LOSS DURING SHIPPING

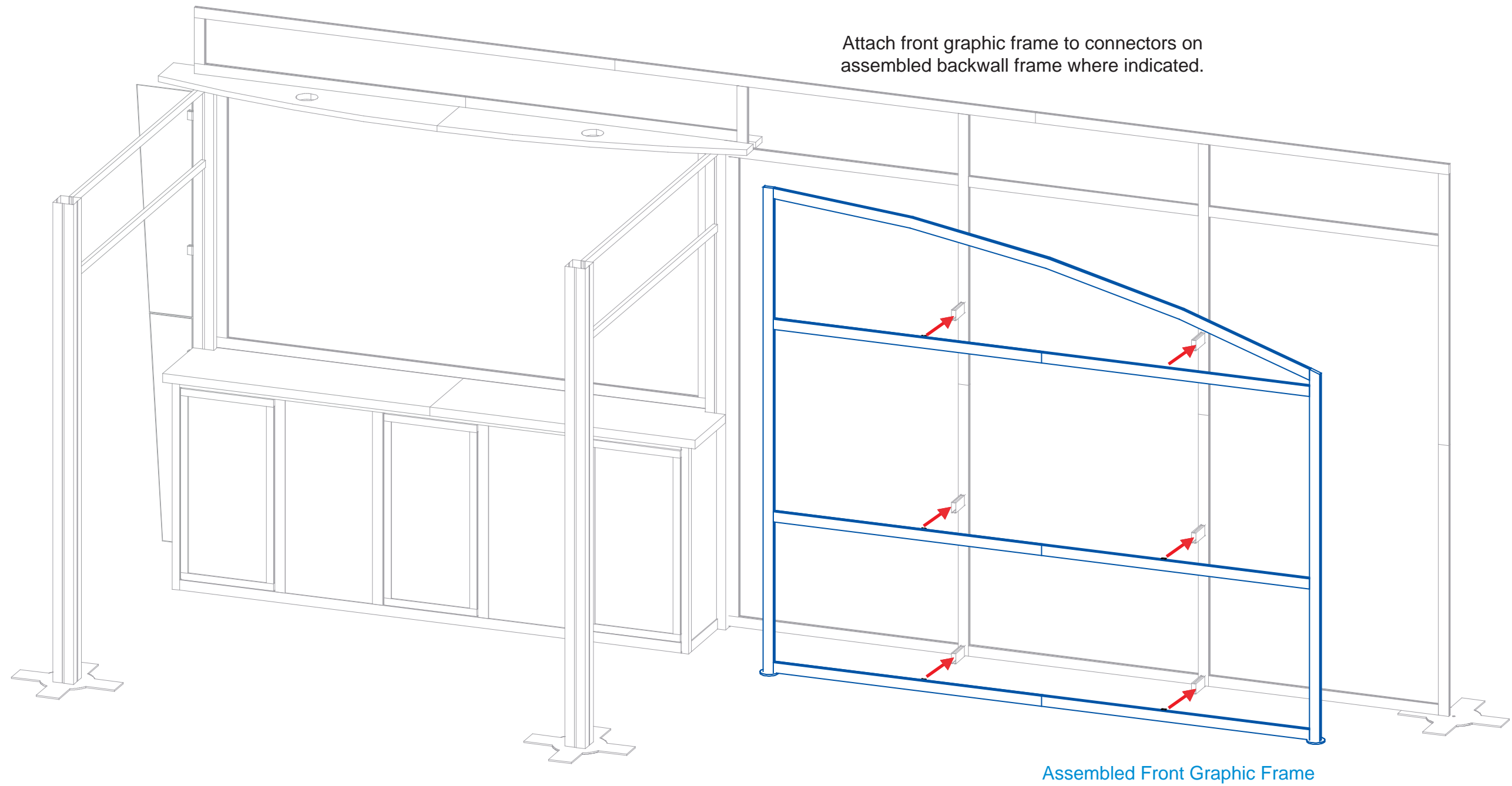

WHEN DISASSEMBLING ALUMINUM EXTRUSION, TIGHTEN ALL SETSCREWS AND LOCKS TO PREVENT LOSS DURING SHIPPING

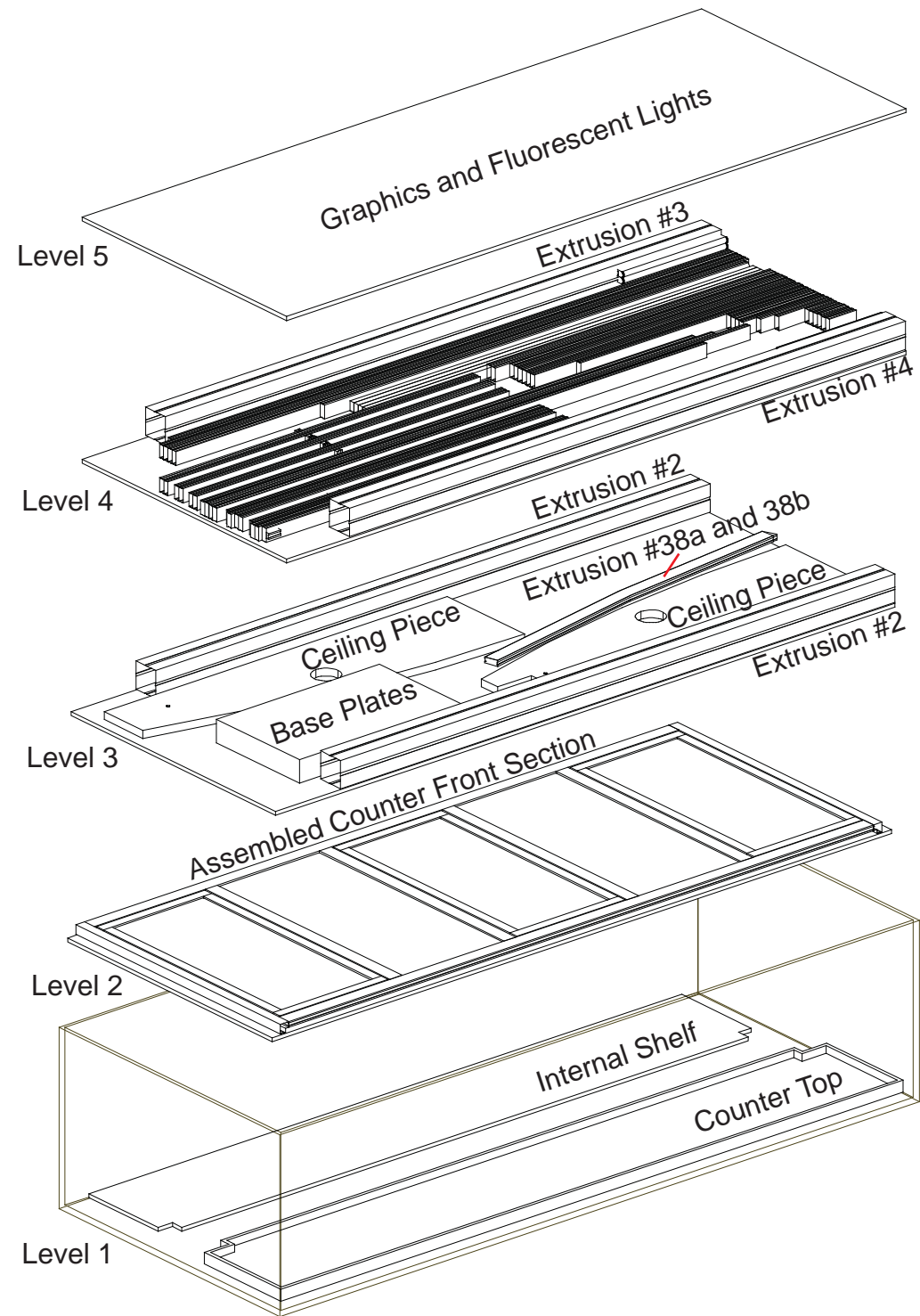

Level 1



Level 2



Level 4



Level 3



Level 5

Top View of Level 4

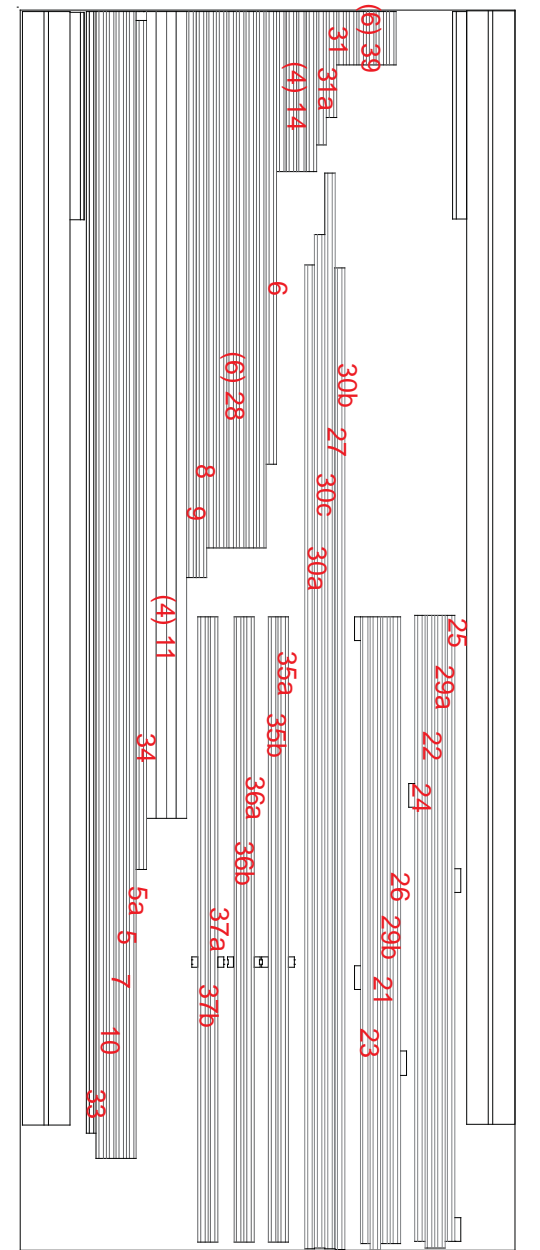

WHEN DISASSEMBLING ALUMINUM EXTRUSION, TIGHTEN ALL SETSCREWS AND LOCKS TO PREVENT LOSS DURING SHIPPING