

visionary™

MAGELLAN DESIGNS

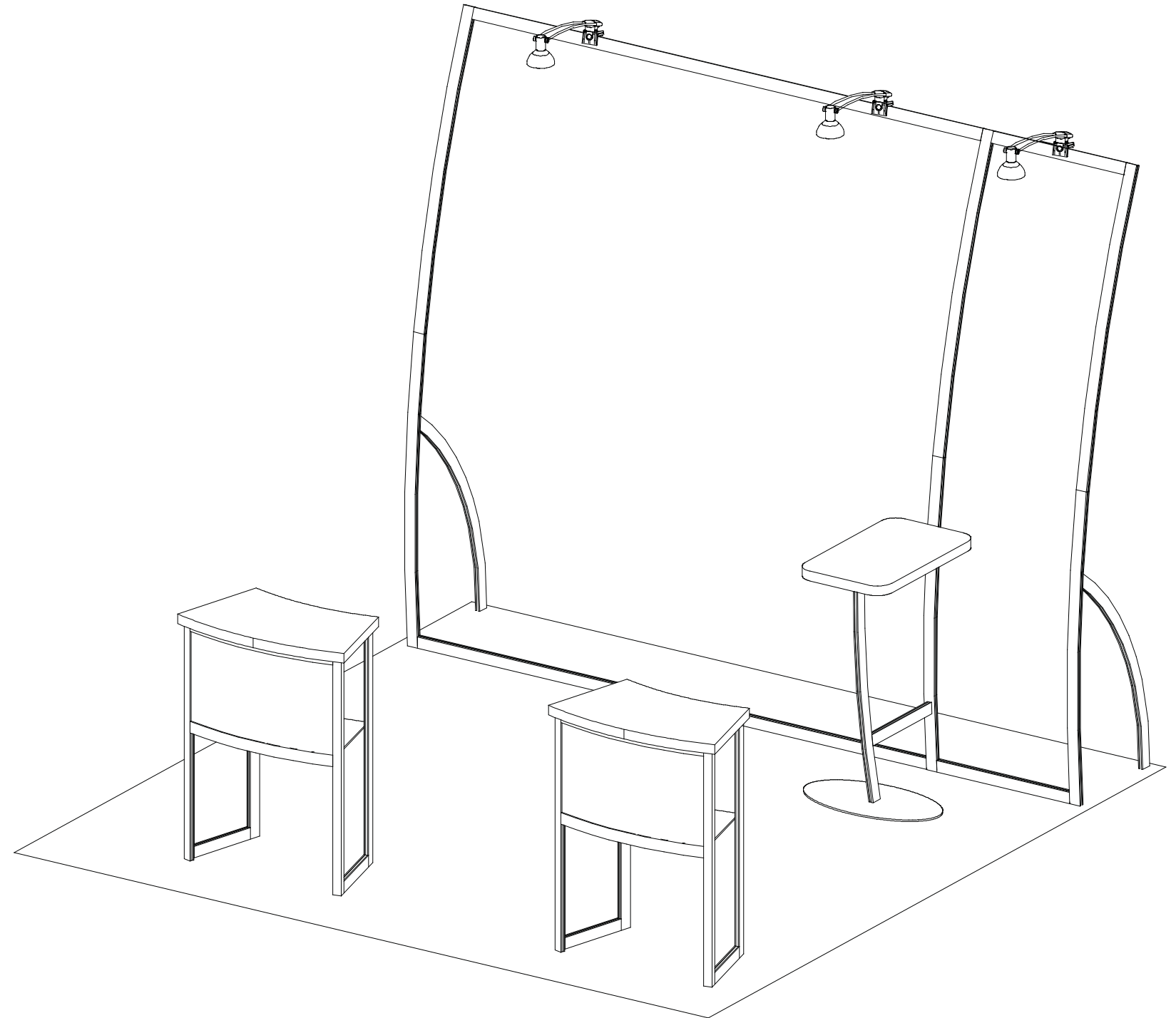
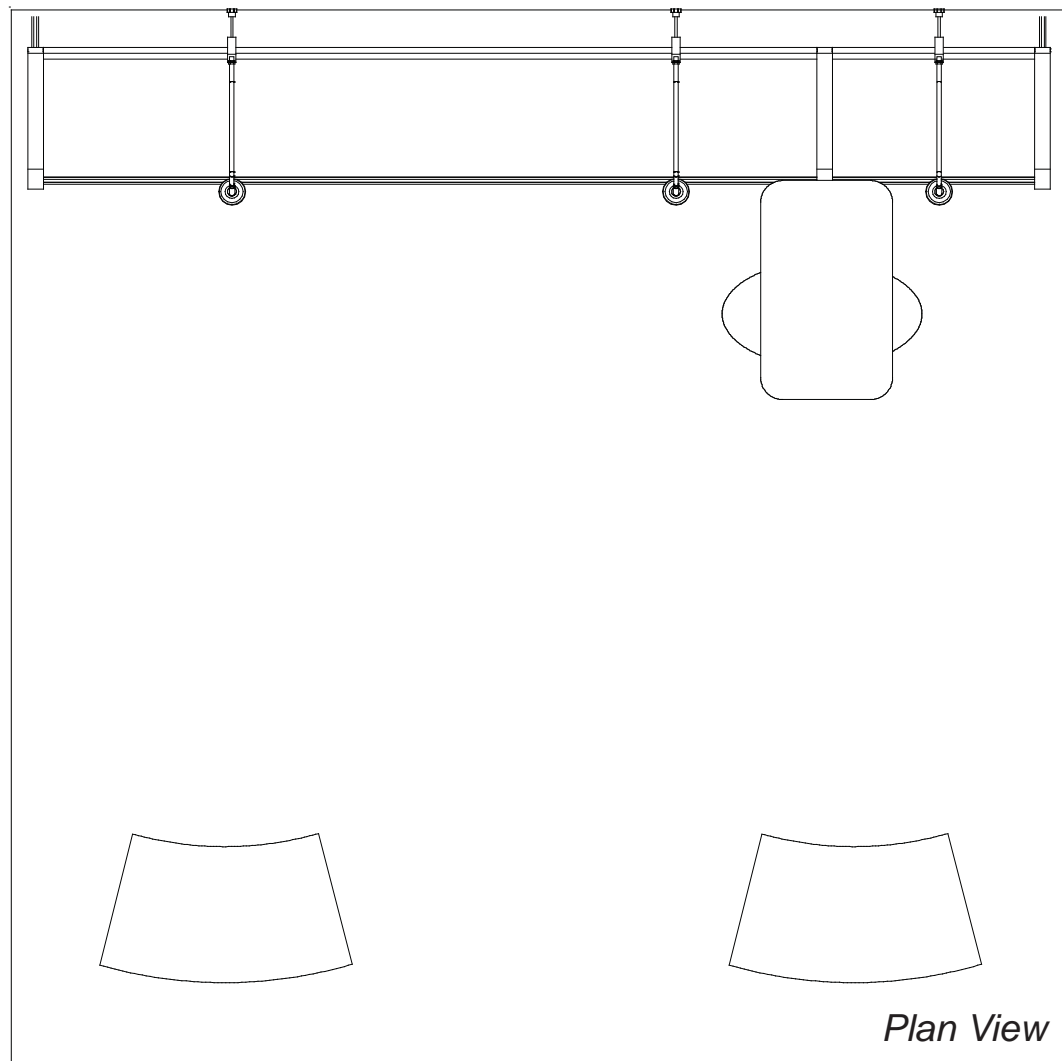

WHEN DISASSEMBLING ALUMINUM EXTRUSION, TIGHTEN ALL SETSCREWS AND LOCKS TO PREVENT LOSS DURING SHIPPING

visionary™ IDESIGNS

Using Your Setup Instructions

The Visionary Designs Setup Instructions are created specifically for your configuration. They are laid out sequentially, including an exploded view of the entire display, and then a logical series of detailed steps to assemble the main structure and components. We encourage you to study the instructions **before** attempting to assemble your exhibit.

Each page reminds you to tighten the setscrews after disassembling your exhibit to prevent loss of the locks and setscrews (see below in RED). This is **VERY IMPORTANT**.

Cleaning and Packing Your Display

- 1) Use care when cleaning aluminum extrusion or acrylic inserts. Use only non-abrasive cleaners.
- 2) When cleaning laminate inserts or countertops, use mild cleansers and a soft material such as cotton.
- 3) Keep all display components away from extreme heat and long exposure to sunlight to avoid warping and fading.
- 4) Retain all packing material. It will make re-packing much easier and will reduce the likelihood of shipping damage.



The Tool

Most Visionary Designs exhibits can be assembled with the supplied Hex Key Tool. Occasionally, a flat head screwdriver may be required.



Typical Connection

Most horizontal extrusion connections have a patented expandable lock. This lock inserts into the groove of an opposing extrusion. Tightening the lock with the Hex Key Tool expands the lock and creates a strong positive connection.



Typical Connection (cont'd)



Detail B

Numbered Label

Each extrusion contains a numbered label which corresponds with setup instructions. The label is located within a groove of the extrusion (when possible). With Visionary Designs the labels contain Black numbers unless otherwise specified.



Detail C

Horizontal Inline Connection (remove only one setscrew)

Remove only (1) setscrew when disassembling. Replace setscrew in extrusion after assembling it. Before packing, replace setscrew in extrusion to avoid losing it.

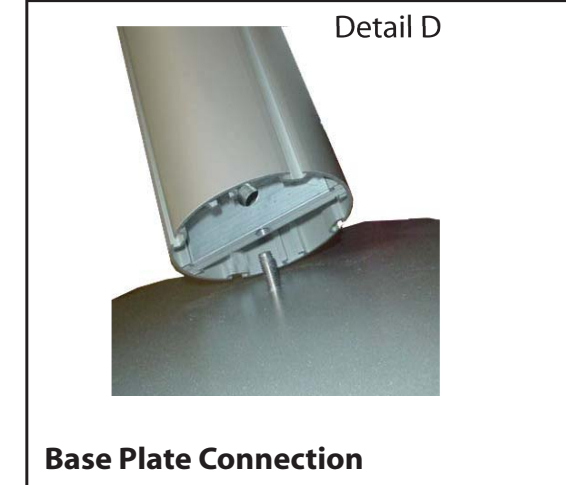

Detail D

Base Plate Connection

Attach base plate to round or square vertical extrusion using the bolt provided. Be careful not to strip the threads.

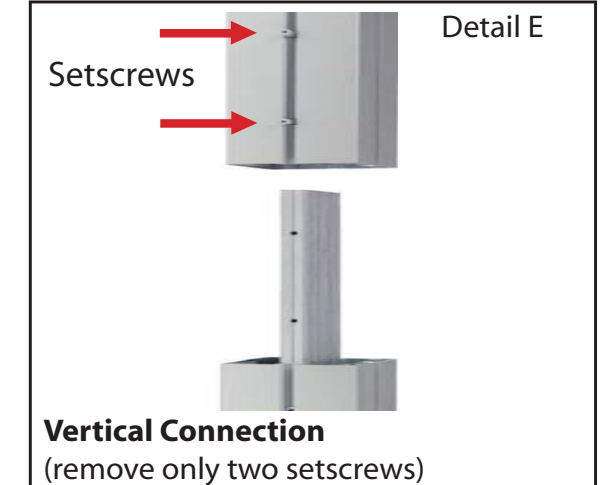

Detail E

Vertical Connection
(remove only two setscrews)

When vertical extrusions are packed in portable cases rather than crates or tubs, they must be broken down into smaller sections which then require assembly.

Remove only (2) setscrews when disassembling. Replace setscrews in extrusion after assembling it. Before packing, replace setscrews in extrusion to avoid losing them.

WHEN DISASSEMBLING ALUMINUM EXTRUSION, TIGHTEN ALL SETSCREWS AND LOCKS TO PREVENT LOSS DURING SHIPPING

Part Number	Qty	Description
1	1	48.5" h Lower Curved Extrusion
2	1	48.5" h Upper Curved Extrusion
3	1	48.5" h Lower Curved Extrusion
4	1	48.5" h Upper Curved Extrusion
5	1	48.5" h Lower Curved Extrusion
6	1	48.5" h Upper Curved Extrusion
7a/7b	1/1	44" w Horizontal Extrusion
8a/8b	1/1	44" w Horizontal Extrusion
9	1	23" w Horizontal Extrusion
10	1	23" w Horizontal Extrusion
11	1	Backwall Support Leg Extrusion
12	1	Backwall Support Leg Extrusion

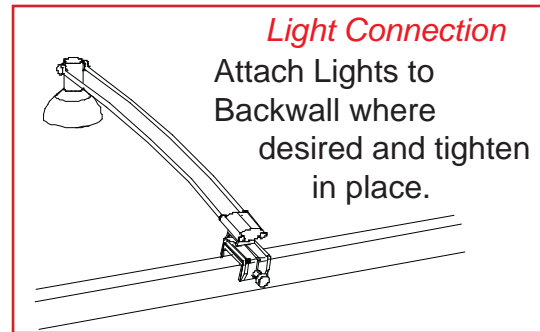

Steps

- 1) Connect backwall upper and lower verticals together [1 to 2, 3 to 4 and 5 to 6].
- 2) Connect horizontal extrusions together [7a to 7b and 8a to 8b].
- 3) Attach horizontal assemblies [7a/7b and 8a/8b] between vertical assemblies [1/2 and 3/4].
- 4) Attach horizontal extrusions [9 and 10] between vertical assemblies [3/4 and 5/6].
- 5) Attach support leg extrusions [11 and 12] to back of verticals [1 and 5], see leg attachment detail.

Rear View of Display

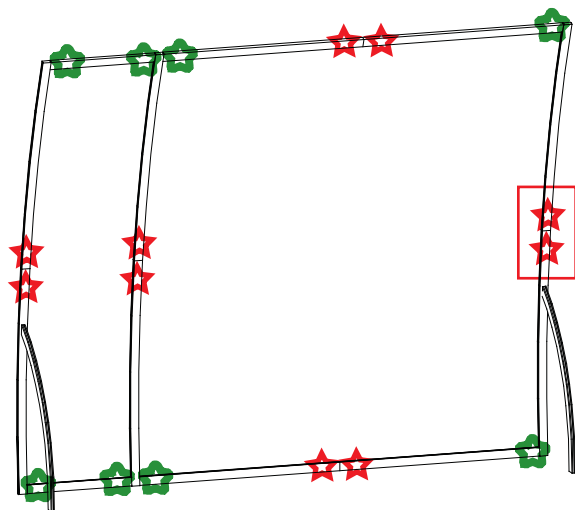

RED STAR indicates location of connection bar knob.

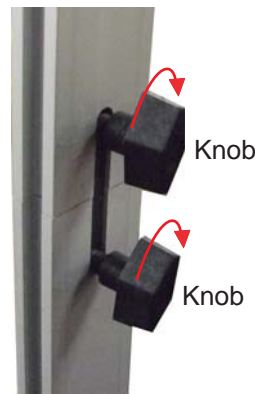

Turn Knob Clockwise to Tighten Lock

Do not over tighten Knobs.

Graphic Attachment
Apply graphics to back of assembled backwall.

Support Leg Attachment

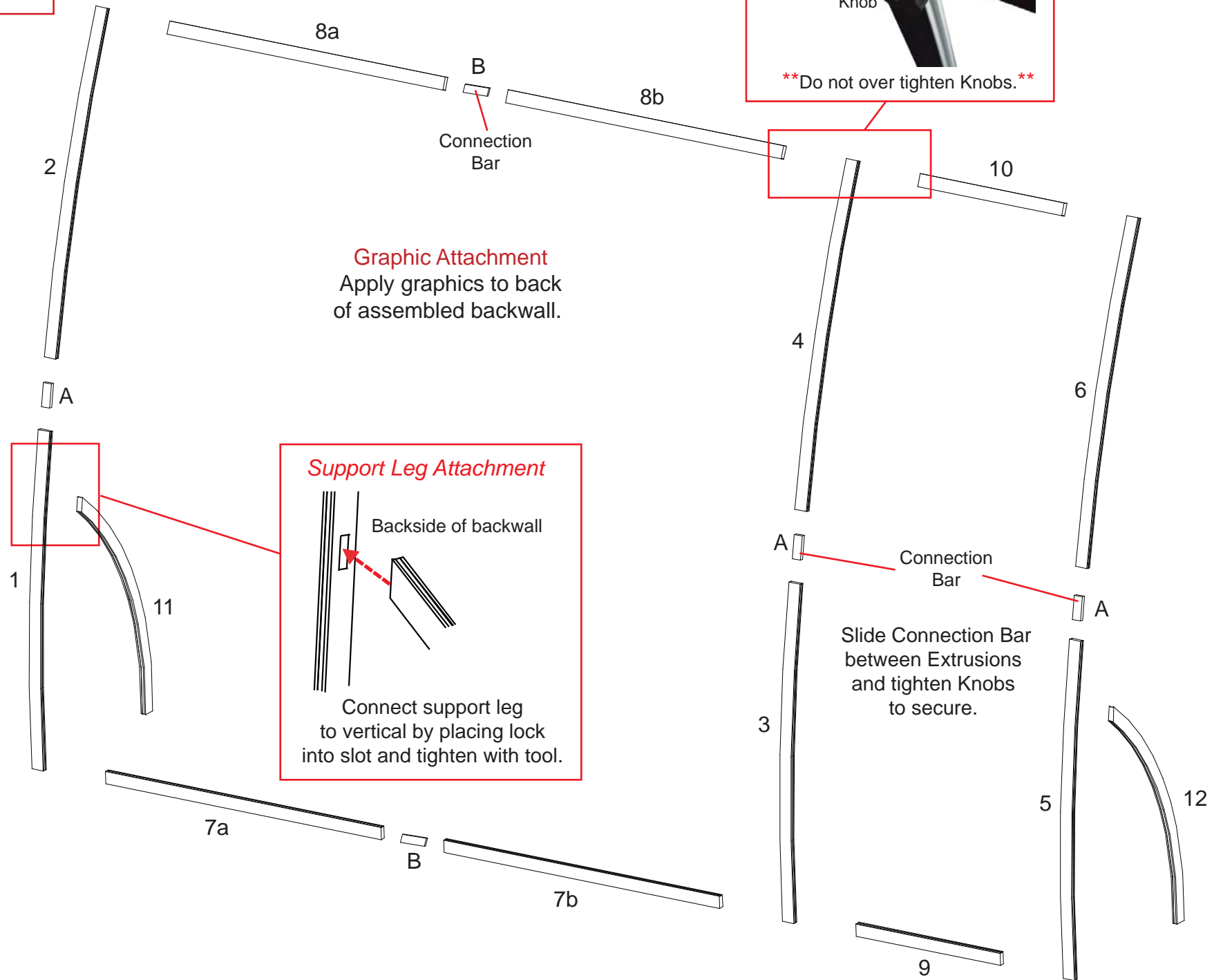
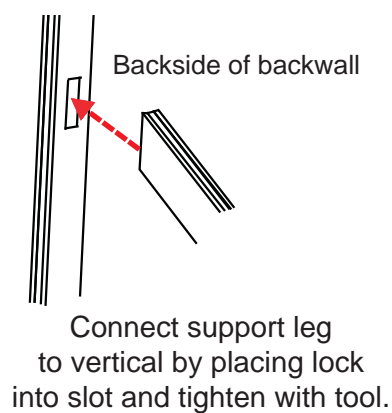

WHEN DISASSEMBLING ALUMINUM EXTRUSION, TIGHTEN ALL SETSCREWS AND LOCKS TO PREVENT LOSS DURING SHIPPING

866.652.2100

Part Number	Qty	Description
13	1	Base Plate
14	1	37.6" h Curved Vertical Extrusion
14a	1	Oval Flange Plate
15	1	18.5" w Horizontal Extrusion
16	1	15.69" w Horizontal Extrusion

Steps

- 1) Attach curved vertical [14] to base plate [13], see Base Plate Attachment detail.
- 2) Attach horizontal extrusions [15 and 16] between curved vertical [14] and backwall vertical [3] where indicated.
- 3) Attach flange plate to top of vertical [14] as shown.
- 4) Place counter top on assembled counter base, see Counter Attachment detail.
- 5) Attach monitor mount to assembled backwall.

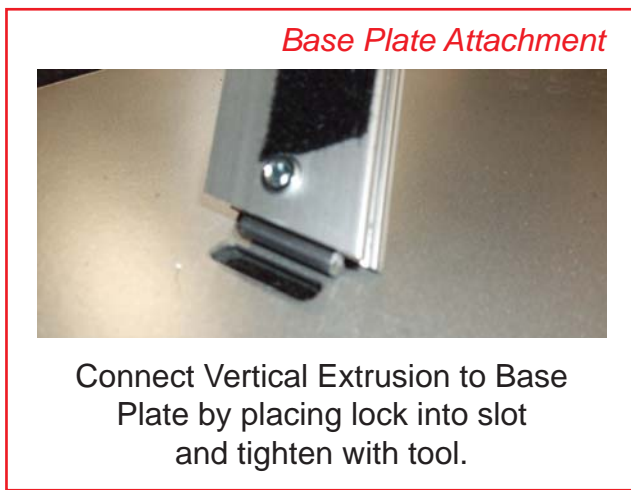
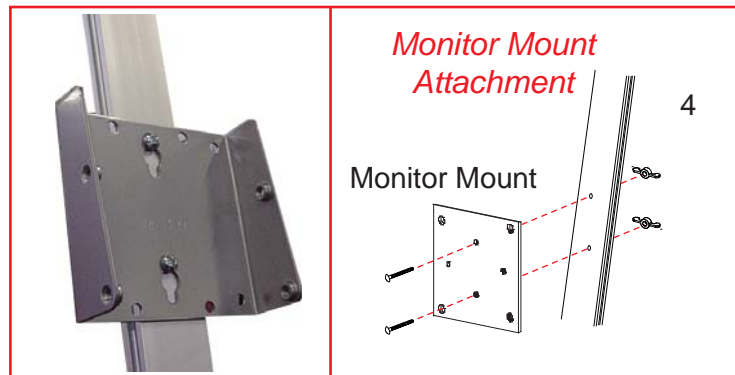
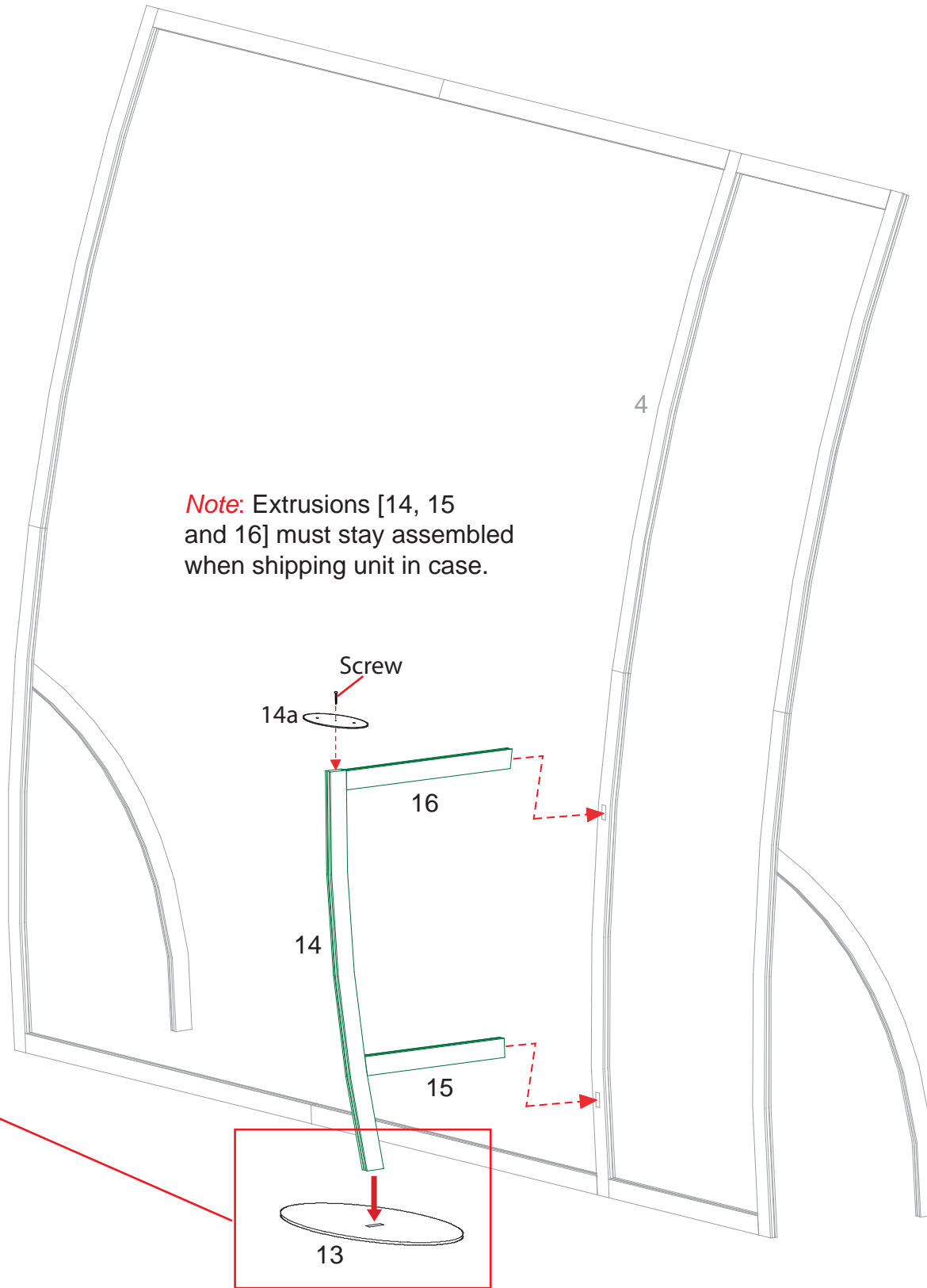

Counter Top Attachment

Insert screws located on underside of counter into holes on flange plate and secure with wing nuts.

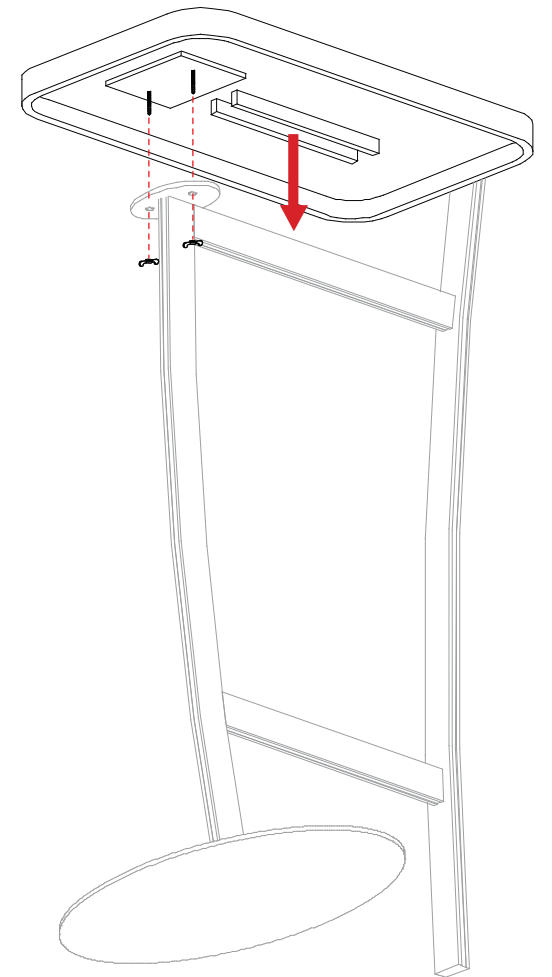

WHEN DISASSEMBLING ALUMINUM EXTRUSION, TIGHTEN ALL SETSCREWS AND LOCKS TO PREVENT LOSS DURING SHIPPING

Part Number	Qty	Description
17	1	37.5" h Vertical Extrusion
18	1	37.5" h Corner Extrusion
19	1	37.5" h Corner Extrusion
20	1	37.5" h Vertical Extrusion
21/21a	4/2	11" w Horizontal Extrusion
22	2	24.875" w Horizontal Extrusion

Steps

- 1) Attach horizontal extrusions [21 and 21a] between vertical extrusions [17&18 and 19&20], see Top View for extrusion orientation.
- 2) Attach curved horizontal extrusions [22] between corner extrusions [18 and 19], placing insert between curved horizontals.

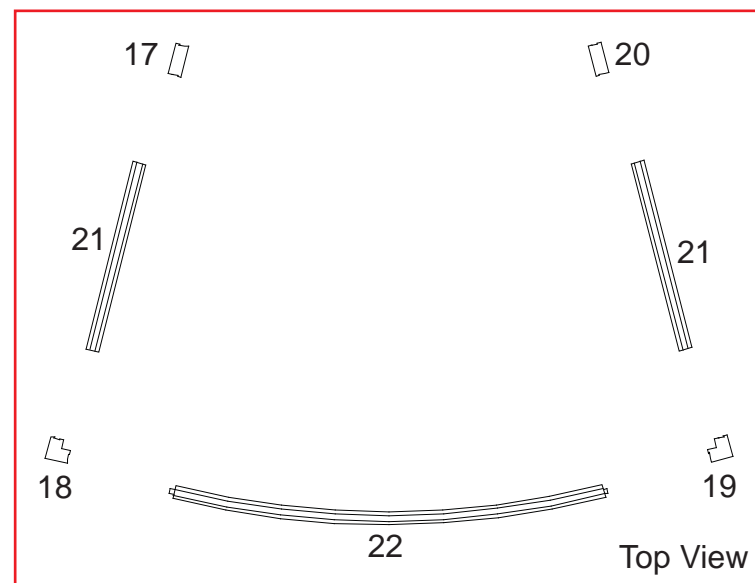

- Steps (Cont'd):
- 3) Place shelf atop lip of extrusions.
 - 4) Set counter top atop assembled base.

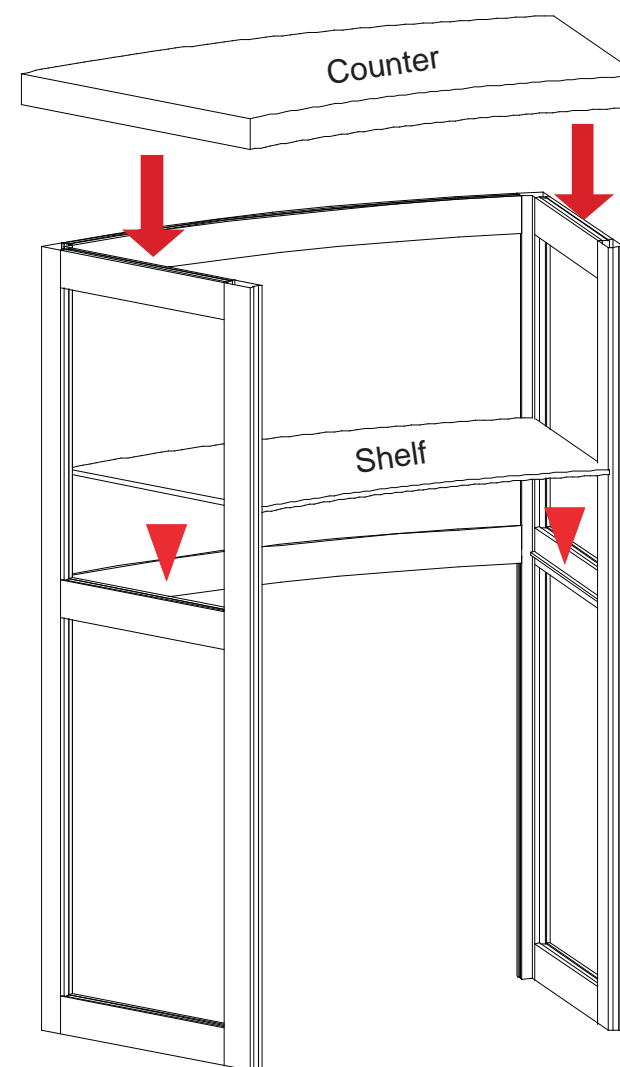
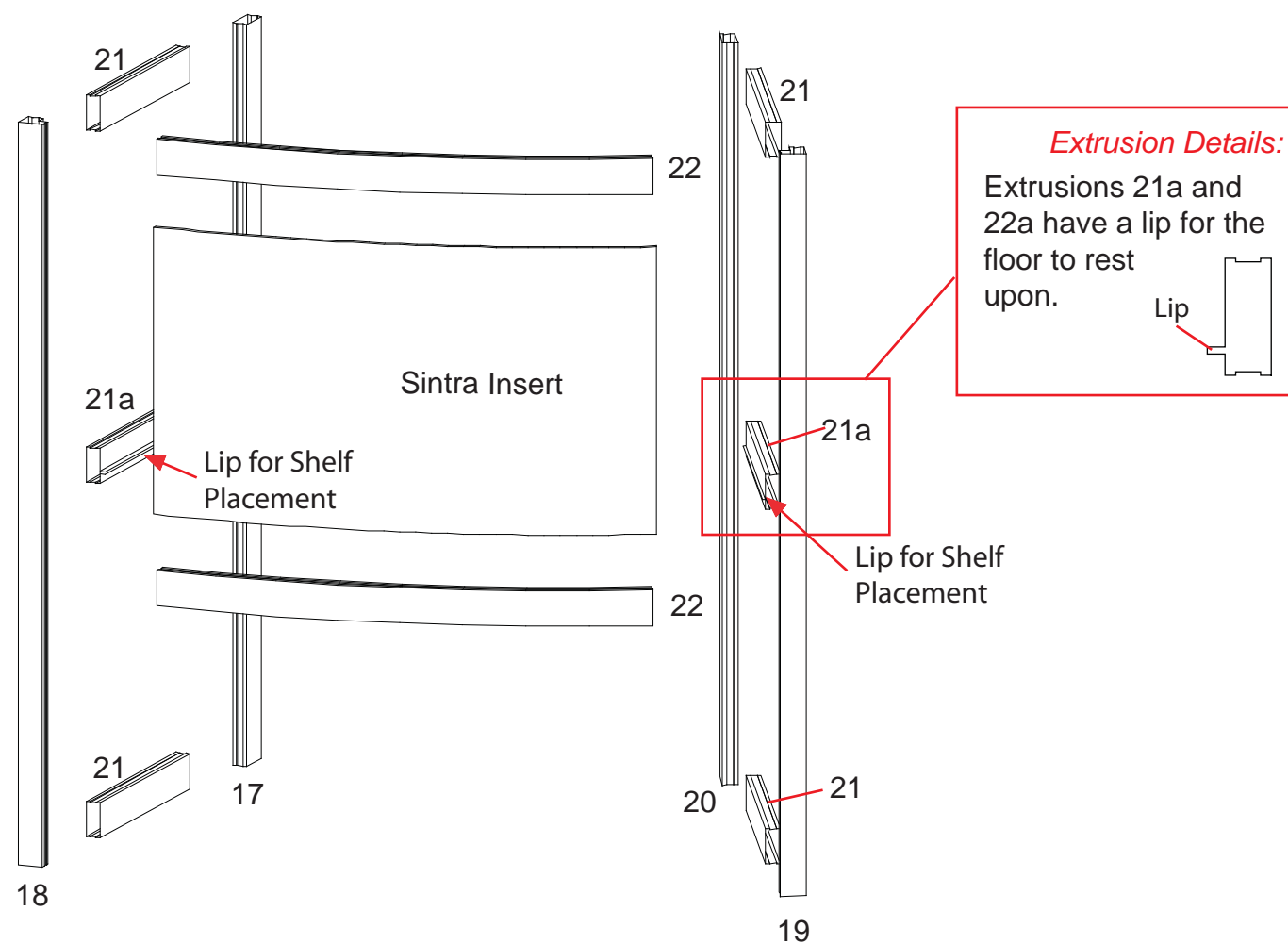
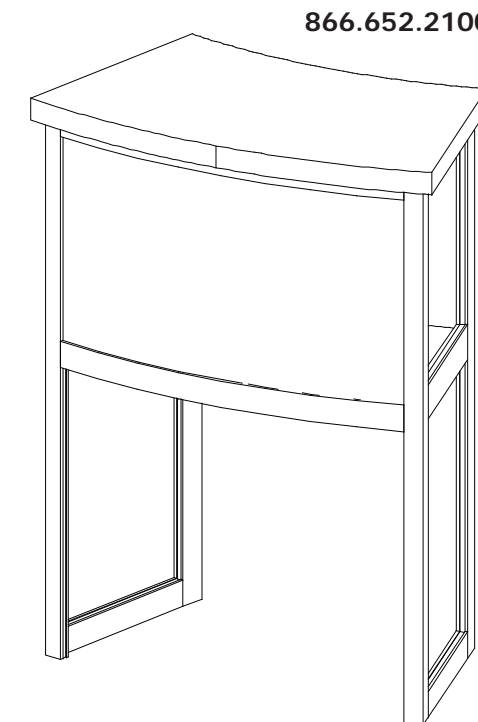

WHEN DISASSEMBLING ALUMINUM EXTRUSION, TIGHTEN ALL SETSCREWS AND LOCKS TO PREVENT LOSS DURING SHIPPING

Case 1: Backwall Components

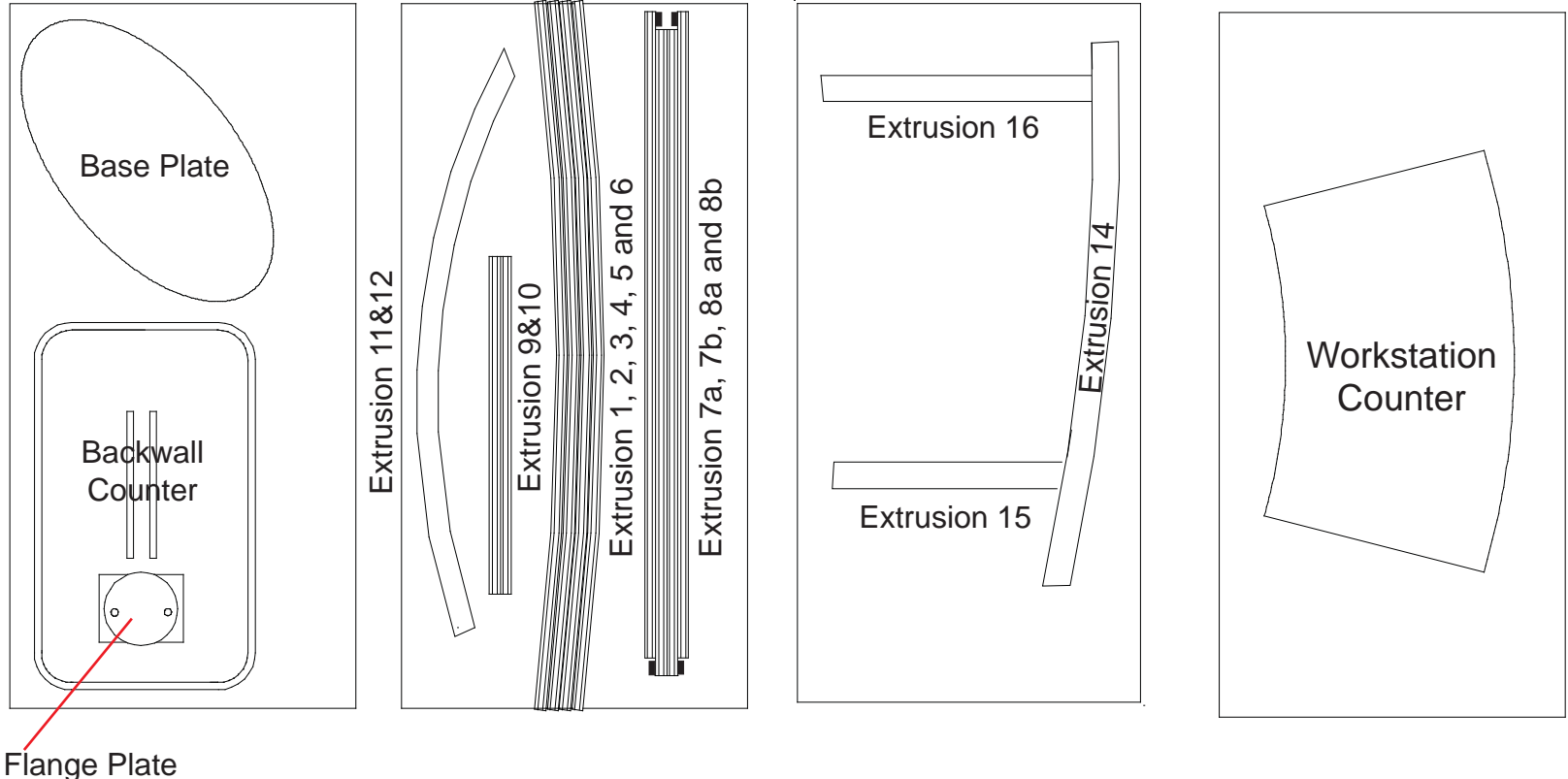

Additional Items:
 Halogen Lights
 Graphics
 Setup Hardware

WHEN DISASSEMBLING ALUMINUM EXTRUSION, TIGHTEN ALL SETSCREWS AND LOCKS TO PREVENT LOSS DURING SHIPPING

Case 2: Workstation components

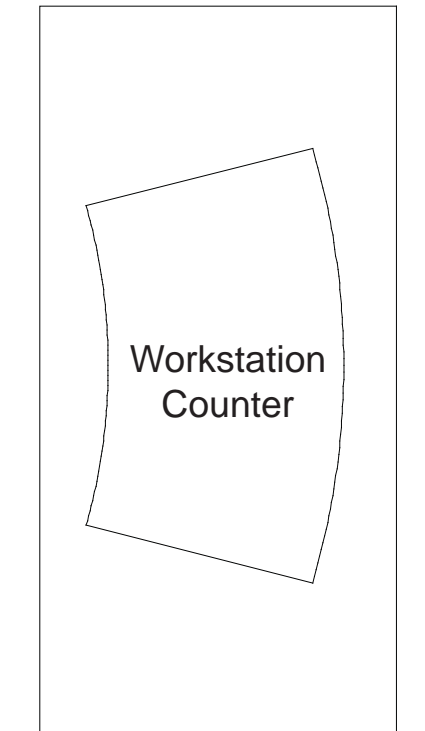
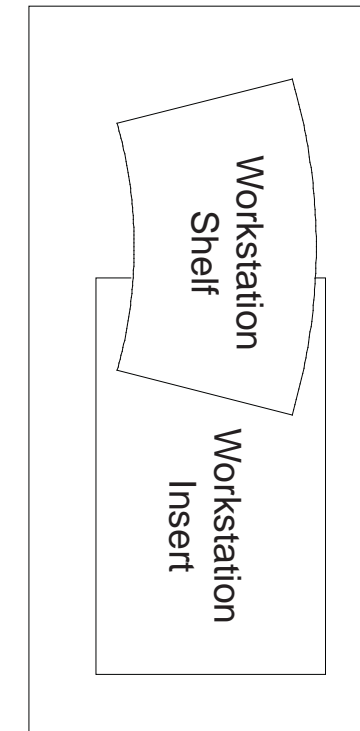
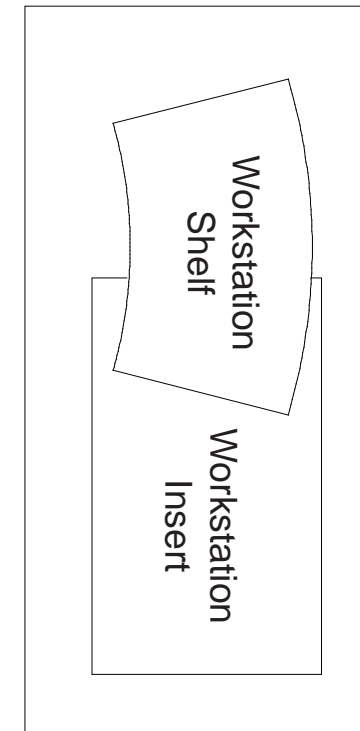
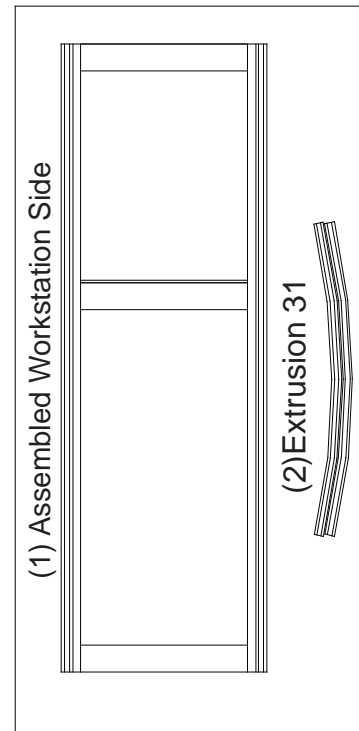
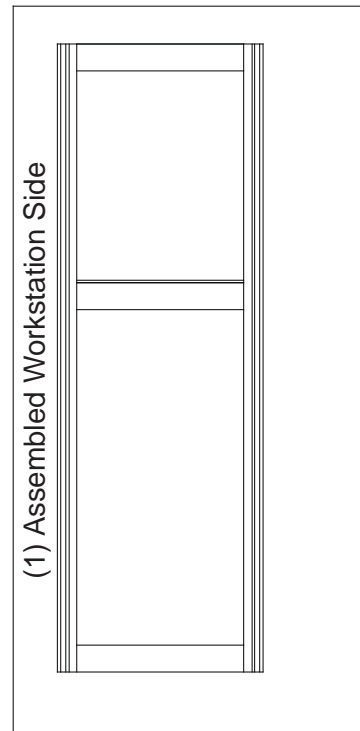
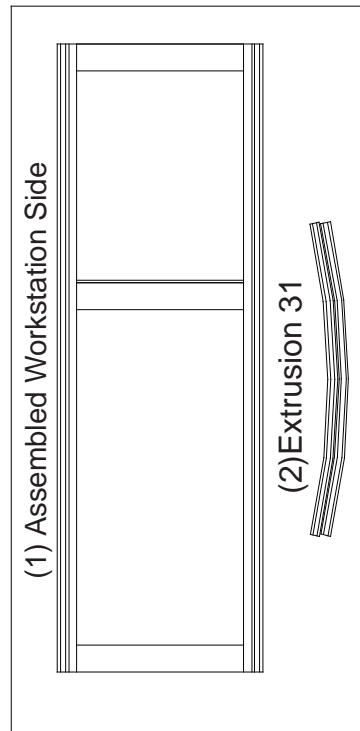
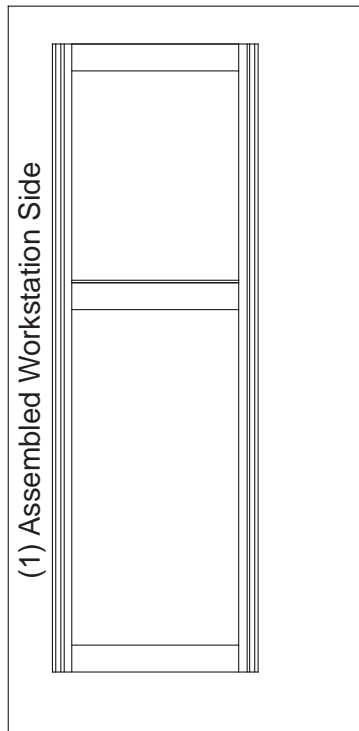

WHEN DISASSEMBLING ALUMINUM EXTRUSION, TIGHTEN ALL SETSCREWS AND LOCKS TO PREVENT LOSS DURING SHIPPING