

Perfect 10 Hybrid Displays

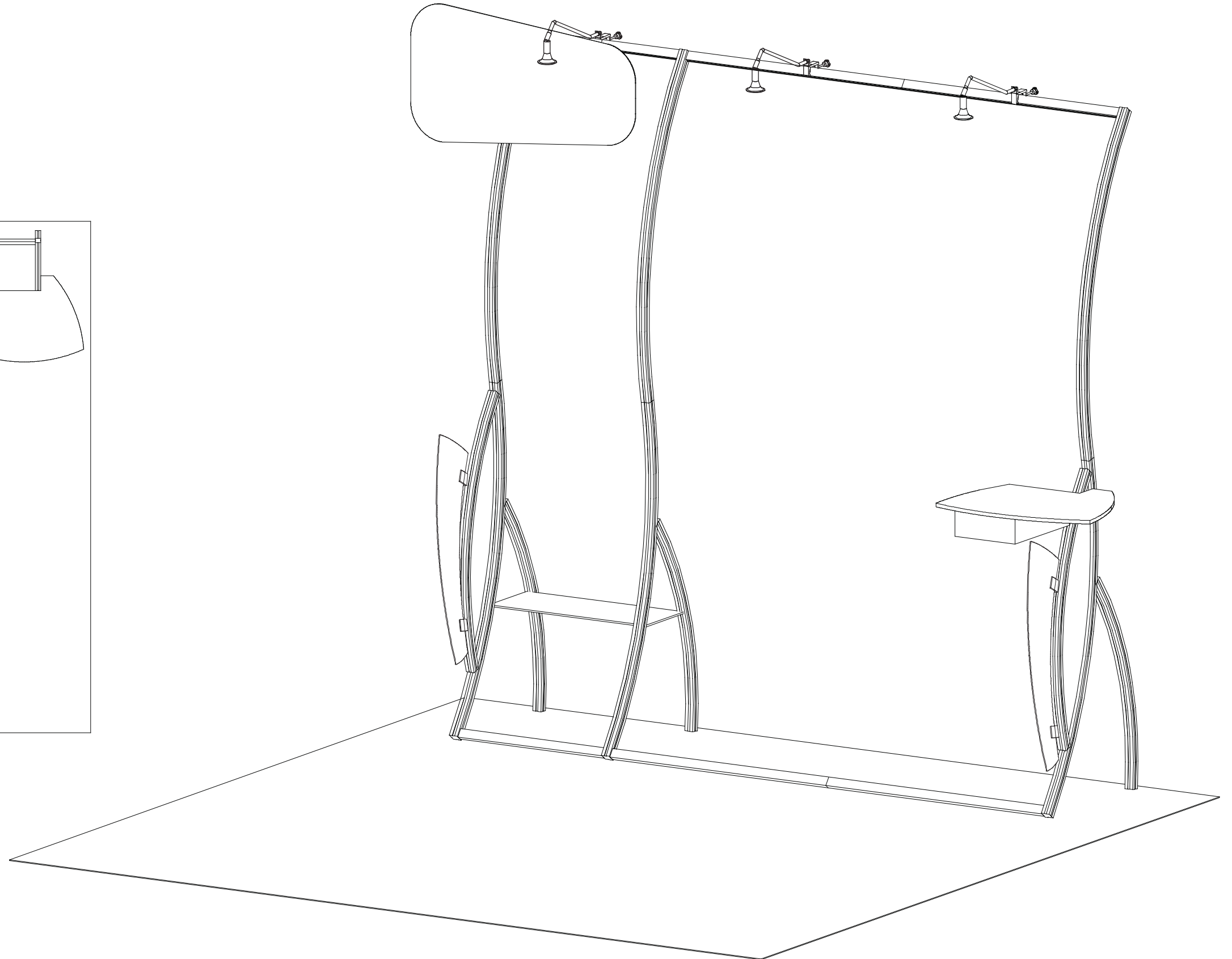
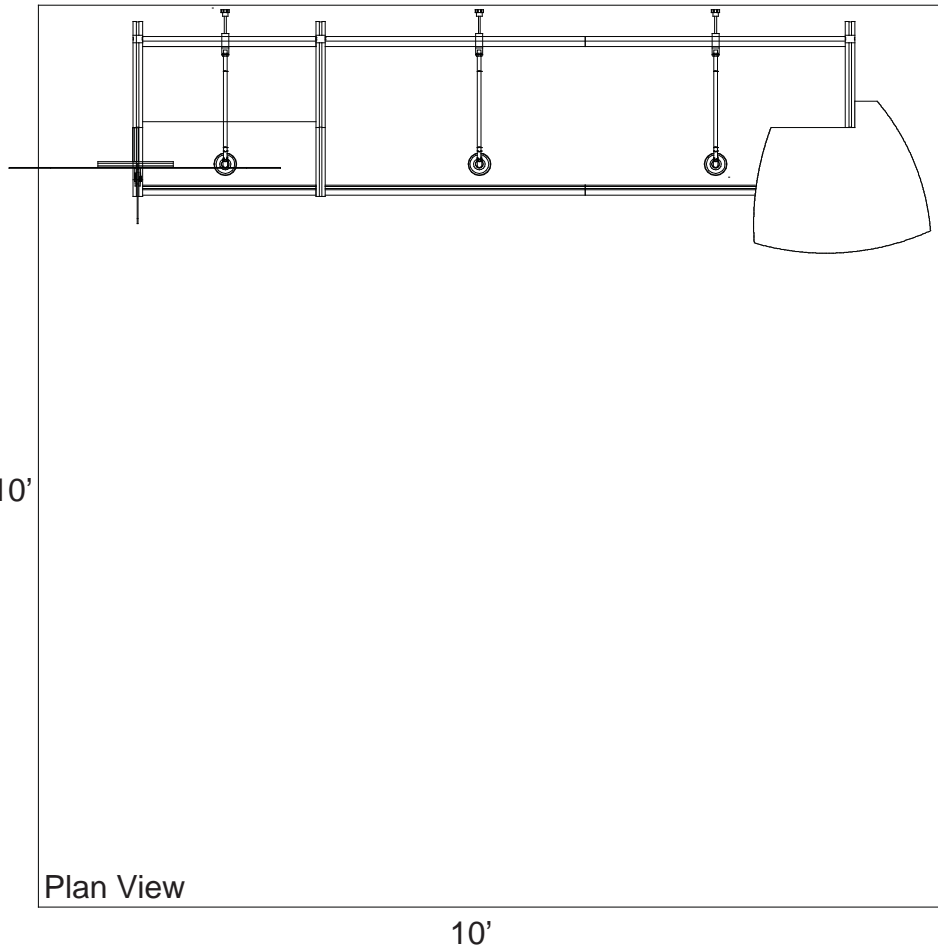

WHEN DISASSEMBLING TIGHTEN ALL KNOBS TO PREVENT LOSS DURING SHIPPING

866.652.2100

Part Number	Description
1	Left Leg Assembly w/ A10 Clamps Attached
2	Middle Leg Assembly
3A	Upper Curved Vertical
3	Upper Curved Vertical
4	23" w Horizontal

Step 1:

NOTE: Can be assembled either face down on floor then lifted upright or upright as shown in drawings.

- A) Connect vertical leg assemblies [1 and 2] together by connecting horizontal extrusions [4] between assemblies tightening BLACK knobs on backside of extrusion making sure Velcro faces toward BACK and placing it about one inch up from bottom and tightening.
- B) Connect vertical extrusions [3 and 3A] to leg assemblies [1 and 2] using vertical connection bar as shown.
- C) Connect upper horizontal extrusion [4] between verticals [3 and 3A] placing it about one inch down from top.

NOTE: Make sure the lock is flush with extrusion before tightening. If lock will not fully engage, gently rock lock and extrusion while turning knob until lock fully opens.



Rear View of Display

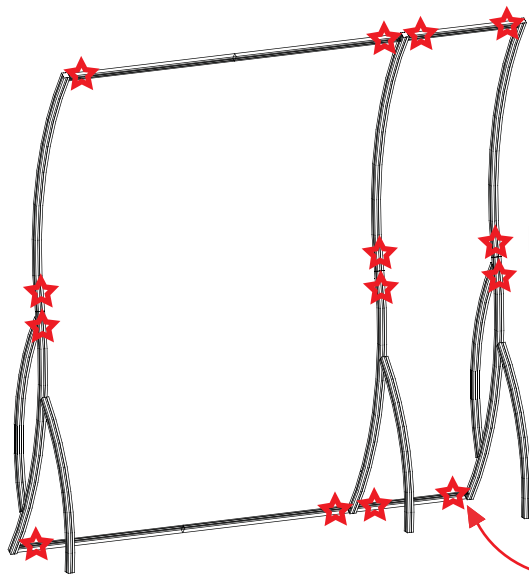

STAR indicates location of knobs on BACKSIDE of unit.

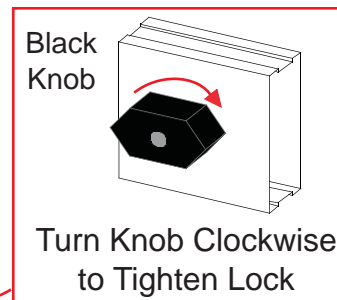

Step 1

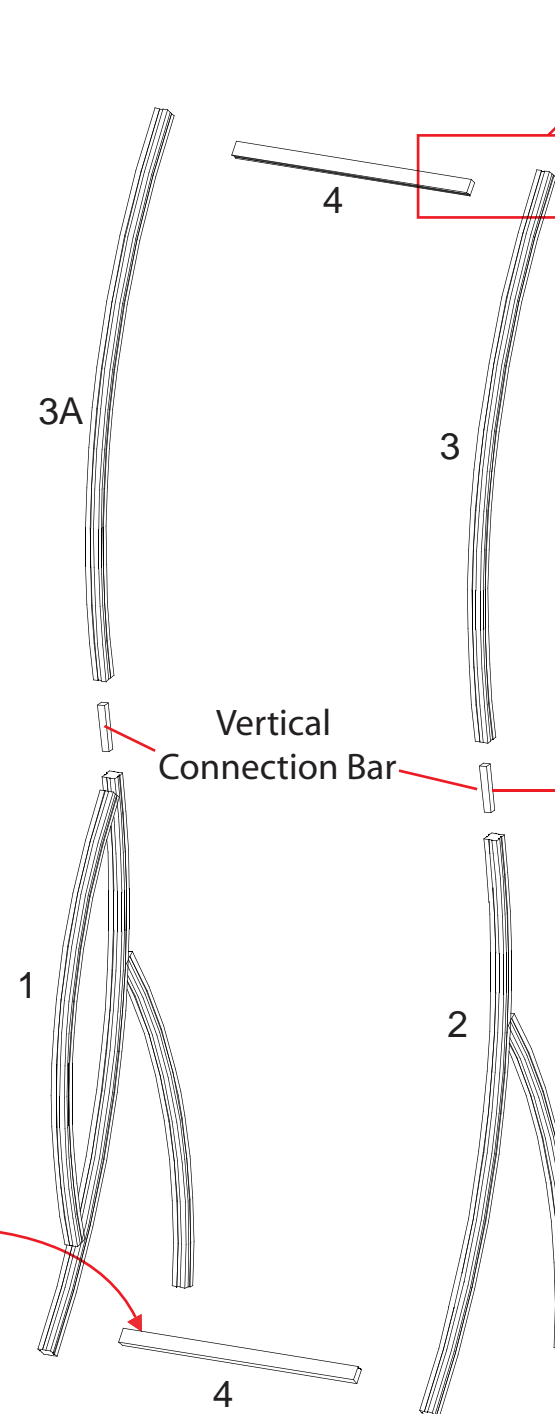

NOTE: When assembling horizontals they should be placed approximately one inch from TOP and BOTTOM.

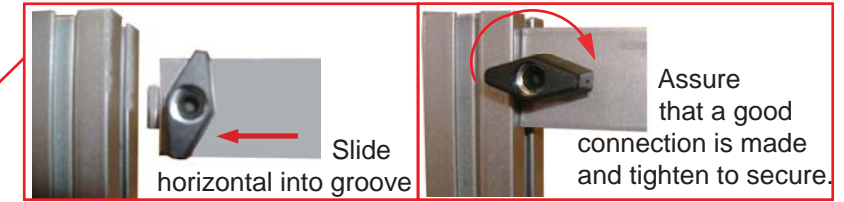

Slide Connection Bar into lower leg assembly. Slide upper vertical over bar and secure both.

Step stool may be required for assembly.



WHEN DISASSEMBLING TIGHTEN ALL KNOBS TO PREVENT LOSS DURING SHIPPING

Part Number	Description
5	Right Leg Assembly w/ A10 Clamps Attached
6	Upper Curved Vertical
7	69" w Horizontal w/ Hinge Facing UP
8	69" w Horizontal w/ Hinge Facing DOWN

Step 2

Step 2:

NOTE: Can be assembled either face down on floor then lifted upright or upright as shown in drawings.

- A) Connect vertical extrusion [6] to leg assembly [5] using vertical connection bar as shown.
- B) Connect horizontal extrusions [7 and 8] between vertical assemblies by tightening BLACK knobs on backside of extrusion making sure Velcro faces toward BACK.

NOTE: Make sure the lock is flush with extrusion before tightening. If lock will not fully engage, gently rock lock and extrusion while turning knob until lock fully opens.



NOTE: When assembling horizontals they should be placed approximately one inch from TOP and BOTTOM.

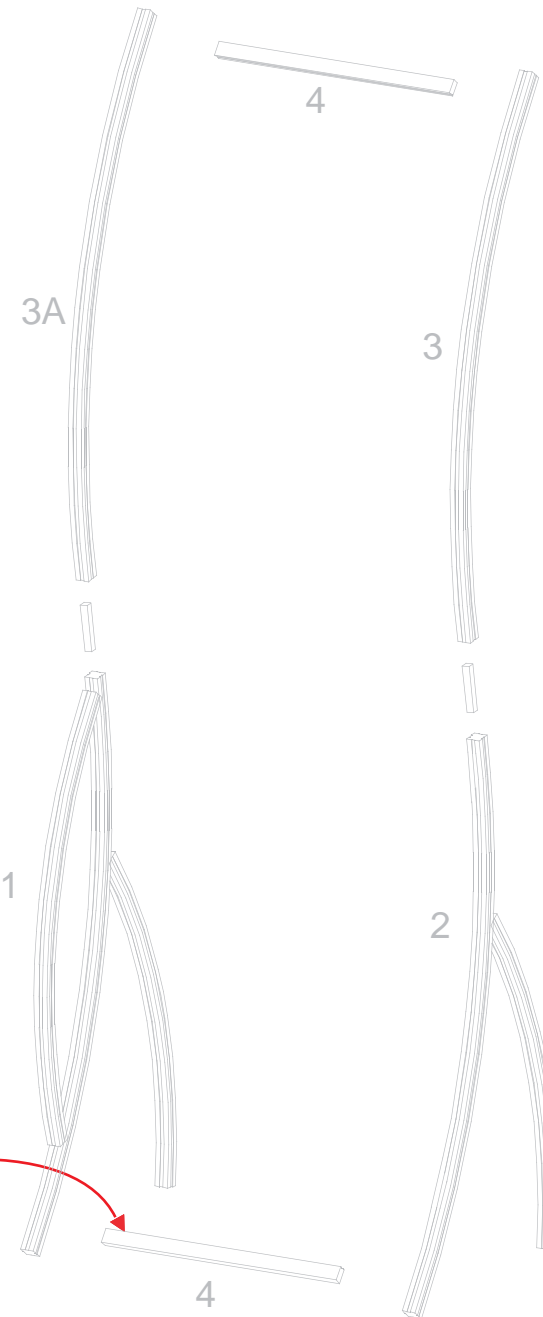
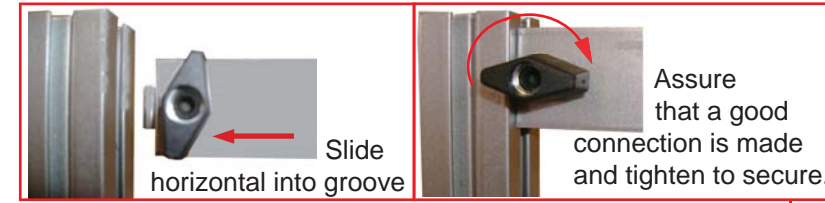

Slide Connection Bar into lower leg assembly. Slide upper vertical over bar and secure both.

Rear View of Display

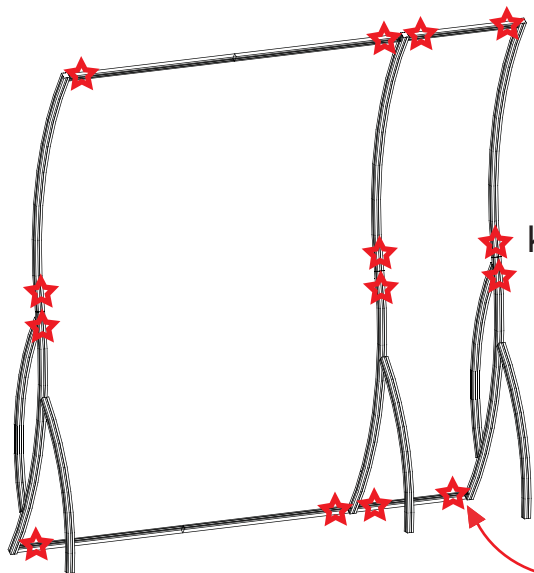

STAR indicates location of knobs on BACKSIDE of unit.

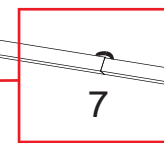
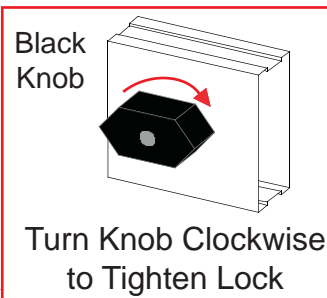

Decorative Blade Attachment (if accidentally removed)
Slide A10 Clamp into groove of square extrusion.



When desired location is found, tighten set screw to secure.

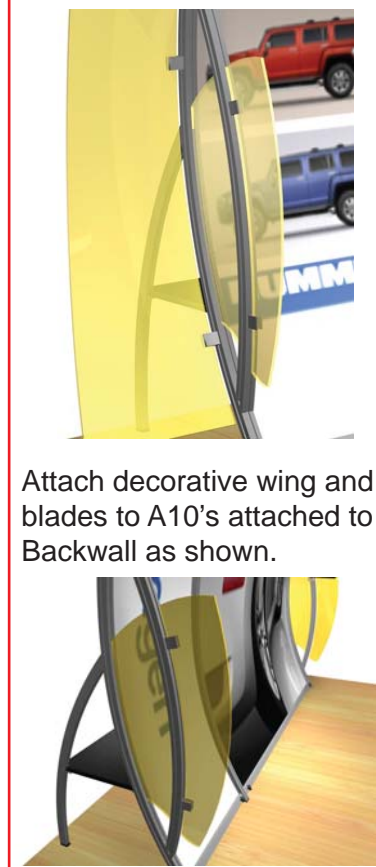

Tighten black plastic set screw to secure Wing in place.

Attach decorative wing and blades to A10's attached to Backwall as shown.

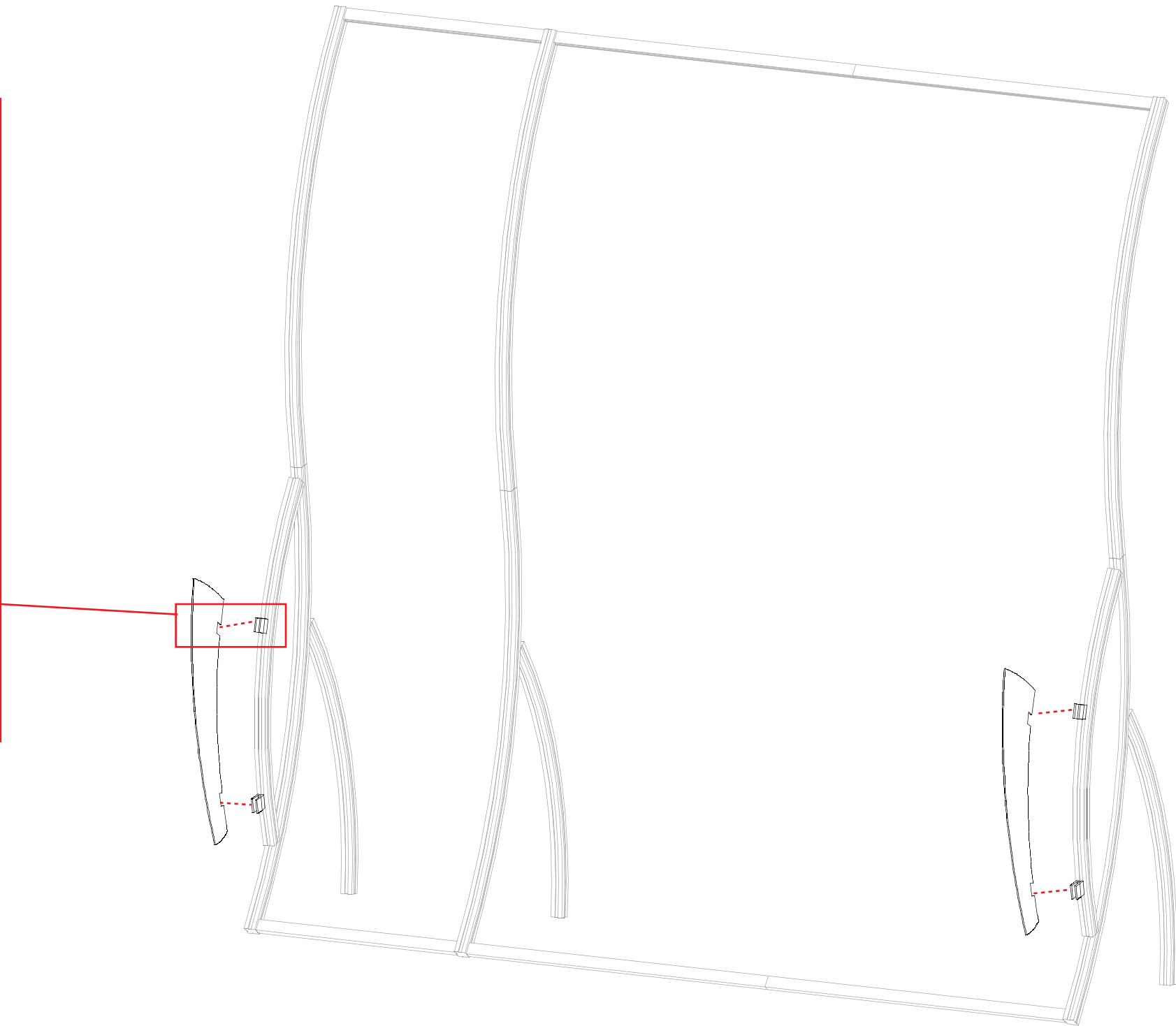
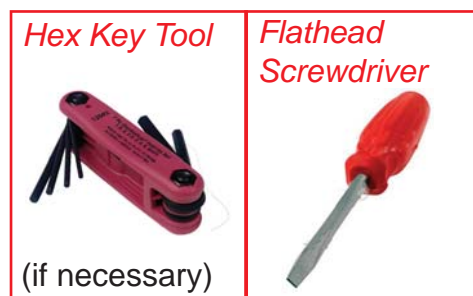

WHEN DISASSEMBLING TIGHTEN ALL KNOBS TO PREVENT LOSS DURING SHIPPING

866.652.2100

Accessory Attachment
 Attach Header support to Backwall then attach header to support by Velcroing it.

Header

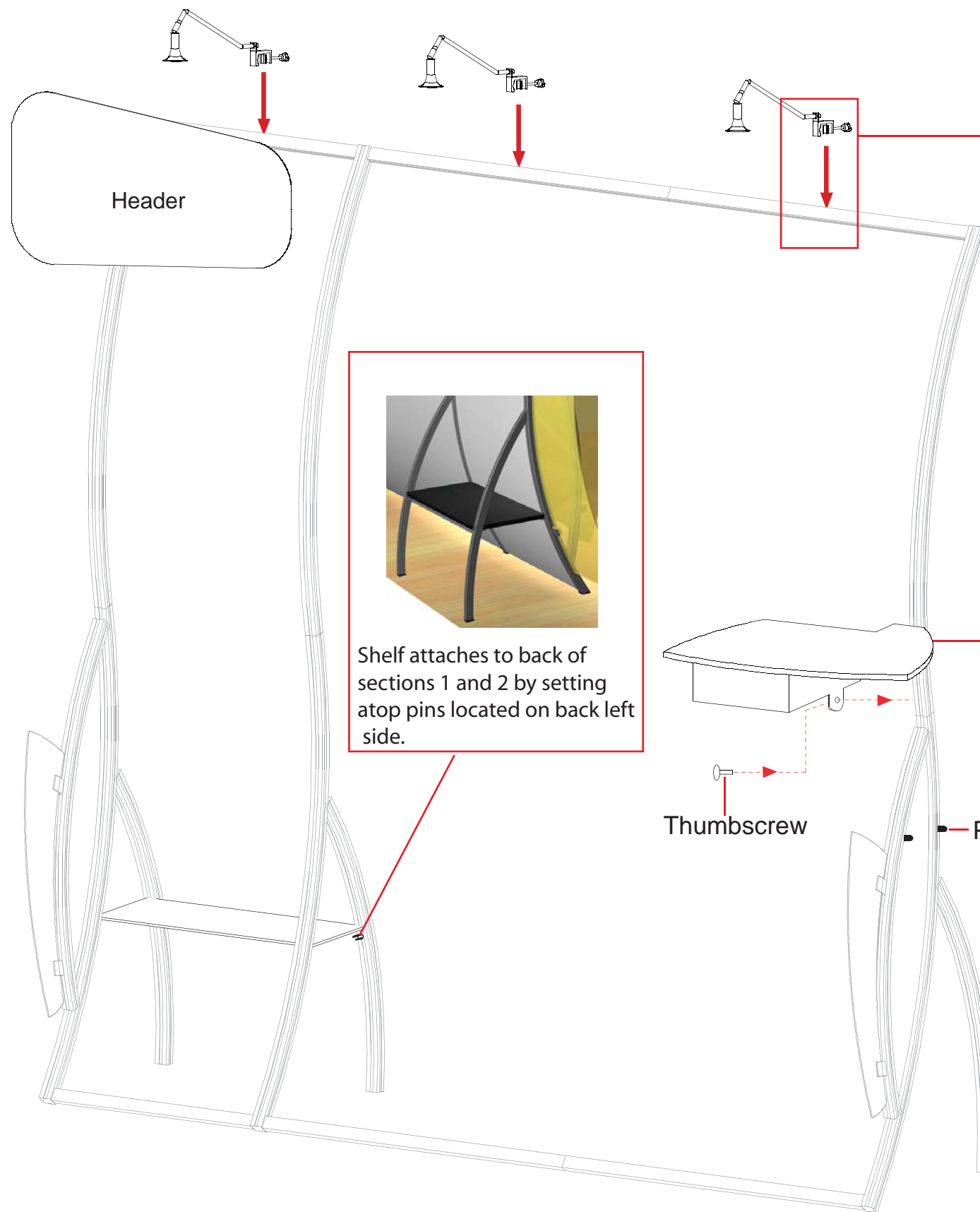

Light Connection
 Attach Lights to Backwall where desired and tighten in place.

Shelf attaches to back of sections 1 and 2 by setting atop pins located on back left side.

Cubby Attachment

Shelf attaches to section 5 by setting atop pins located on right side and securing into place with thumbscrew on left.

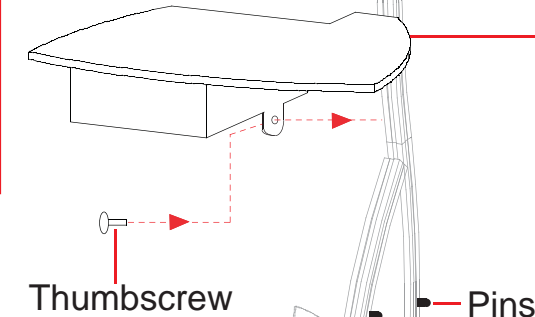

Slide onto back pin first.

When attaching counter you will need to first slide shelf onto back pin then set down on front pin.

WHEN DISASSEMBLING TIGHTEN ALL KNOBS TO PREVENT LOSS DURING SHIPPING

Case #1 - Backwall Components

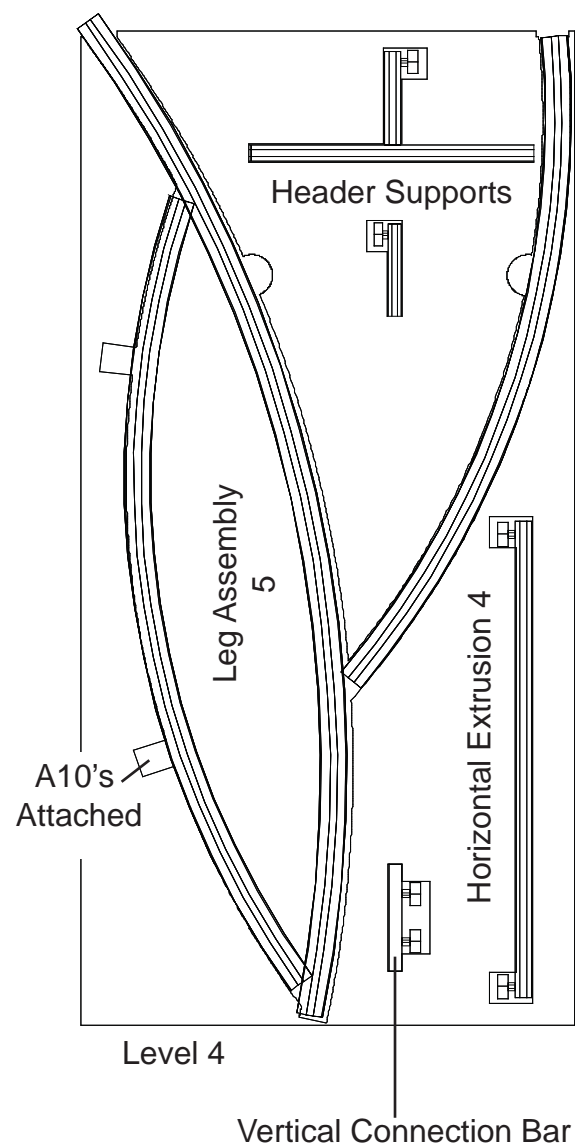
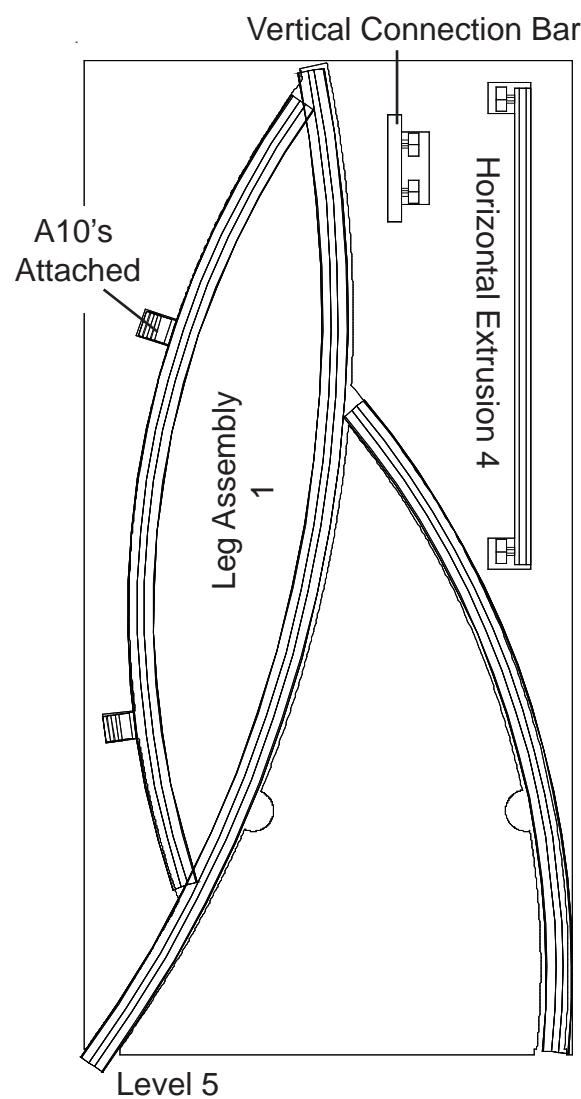

Top View of each Level

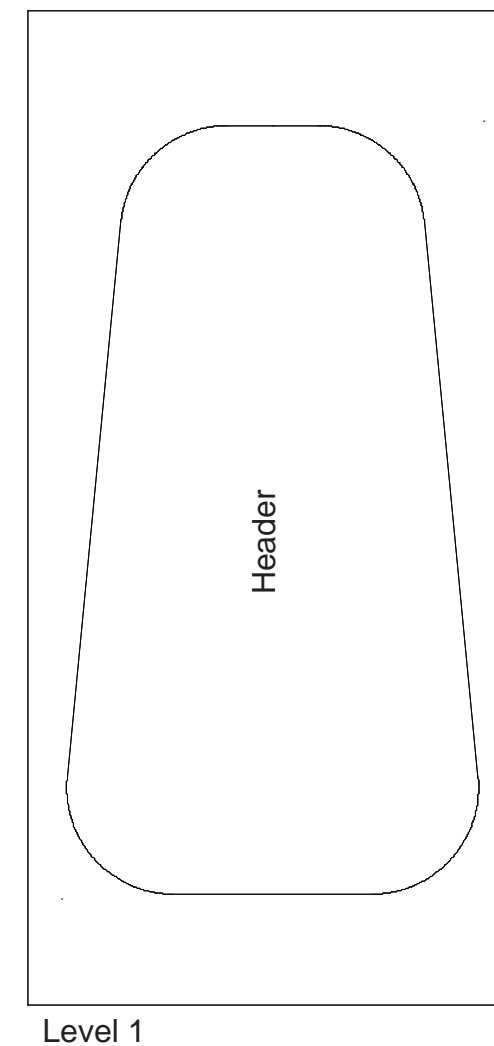
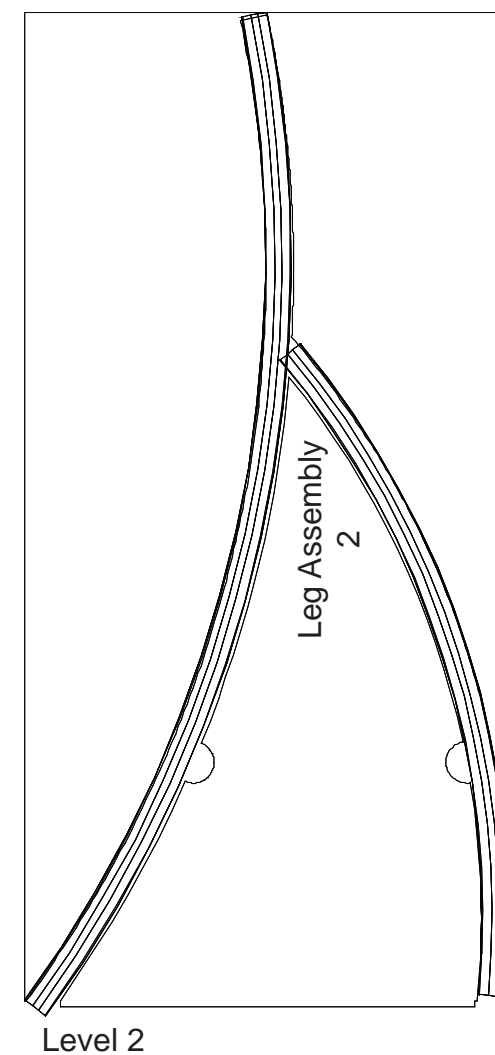
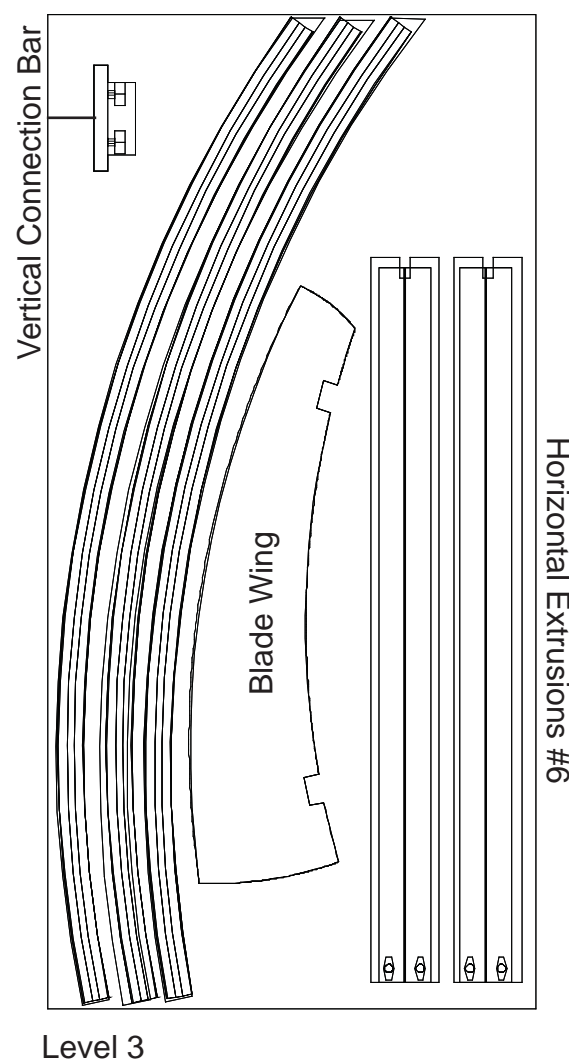

WHEN DISASSEMBLING TIGHTEN ALL KNOBS TO PREVENT LOSS DURING SHIPPING

Case #2 - Backwall Components

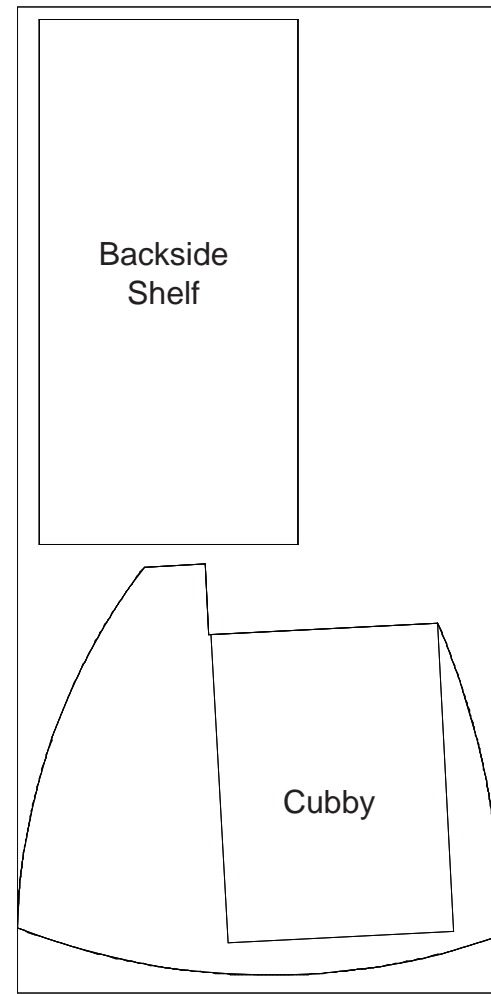

Level 1

WHEN DISASSEMBLING TIGHTEN ALL KNOBS TO PREVENT LOSS DURING SHIPPING