

Perfect 10 Hybrid Displays

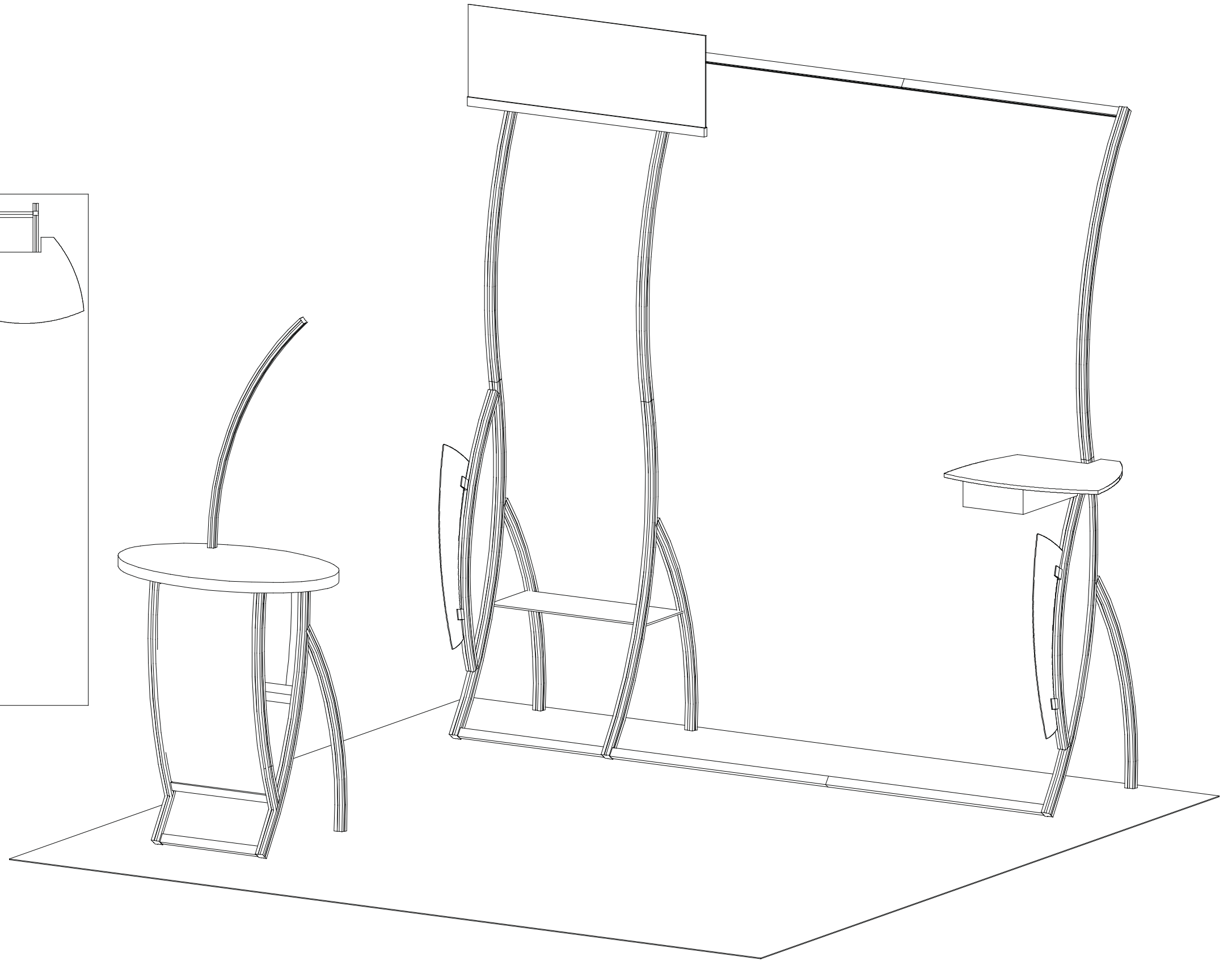
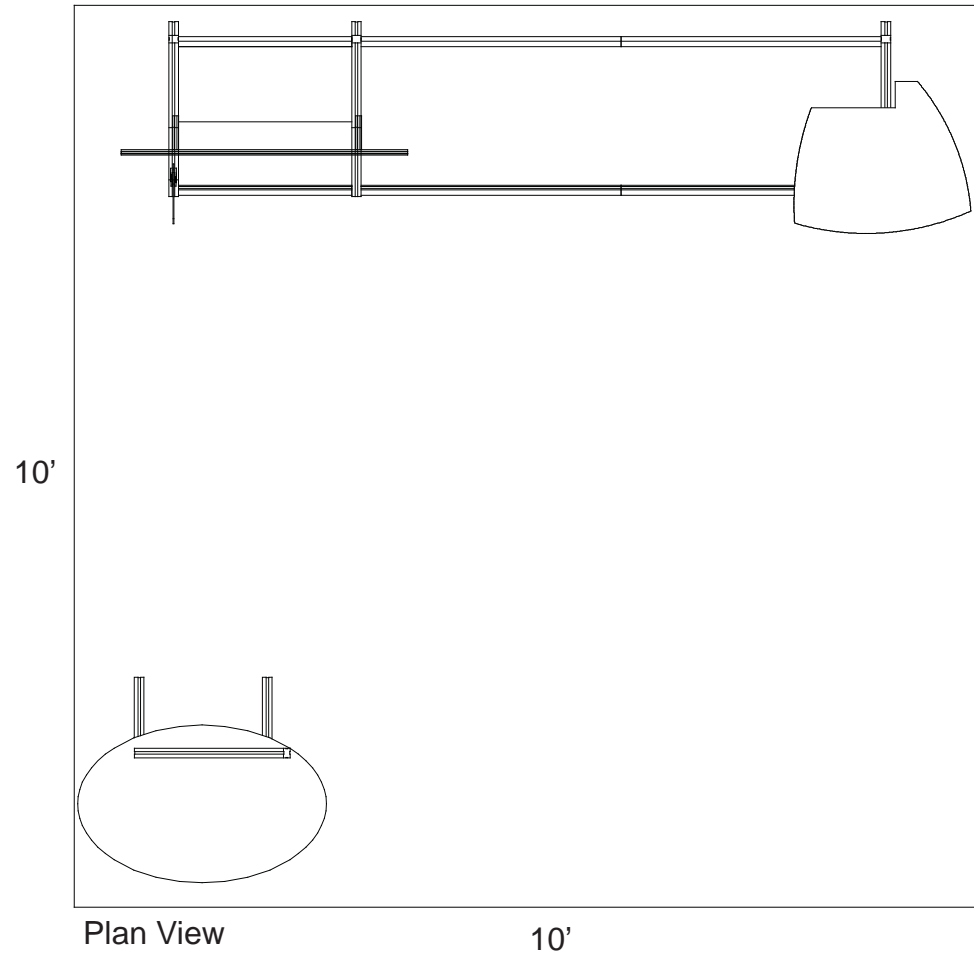

WHEN DISASSEMBLING TIGHTEN ALL BLACK KNOBS TO PREVENT LOSS DURING SHIPPING

866.652.2100

Part Number	Description
1	Left Leg Assembly w/ A10 Clamps Attached
2	Middle Leg Assembly
3A	Upper Curved Vertical w/ A10 Clamps Attached
3	Upper Curved Vertical
4	23" w Horizontal



Step 1:

NOTE: Can be assembled either face down on floor then lifted upright or upright as shown in drawings.

- A) Connect vertical leg assemblies [1 and 2] together by connecting horizontal extrusions [4] between assemblies tightening BLACK knobs on backside of extrusion making sure Velcro faces toward BACK and placing it about one inch up from bottom and tightening.
- B) Connect vertical extrusions [3 and 3A] to leg assemblies [1 and 2] using vertical connection bar as shown.
- C) Connect upper horizontal extrusion [4] between verticals [3 and 3A] placing it about one inch down from top.

NOTE: Make sure the lock is flush with extrusion before tightening. If lock will not fully engage, gently rock lock and extrusion while turning knob until lock fully opens.

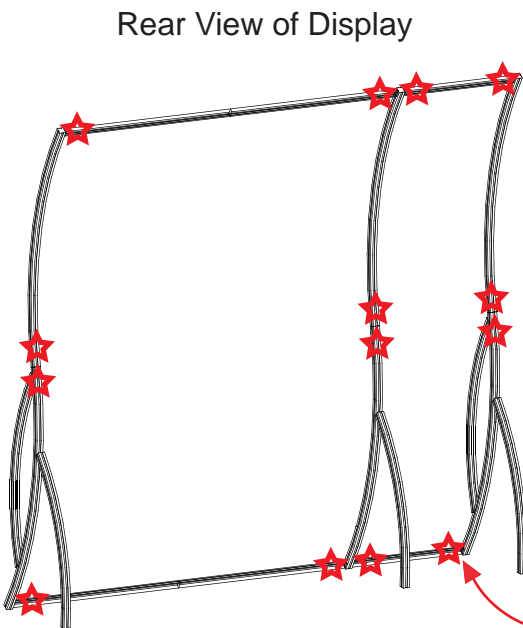

STAR indicates location of knobs on BACKSIDE of unit.

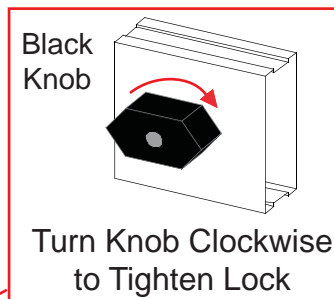

Step 1

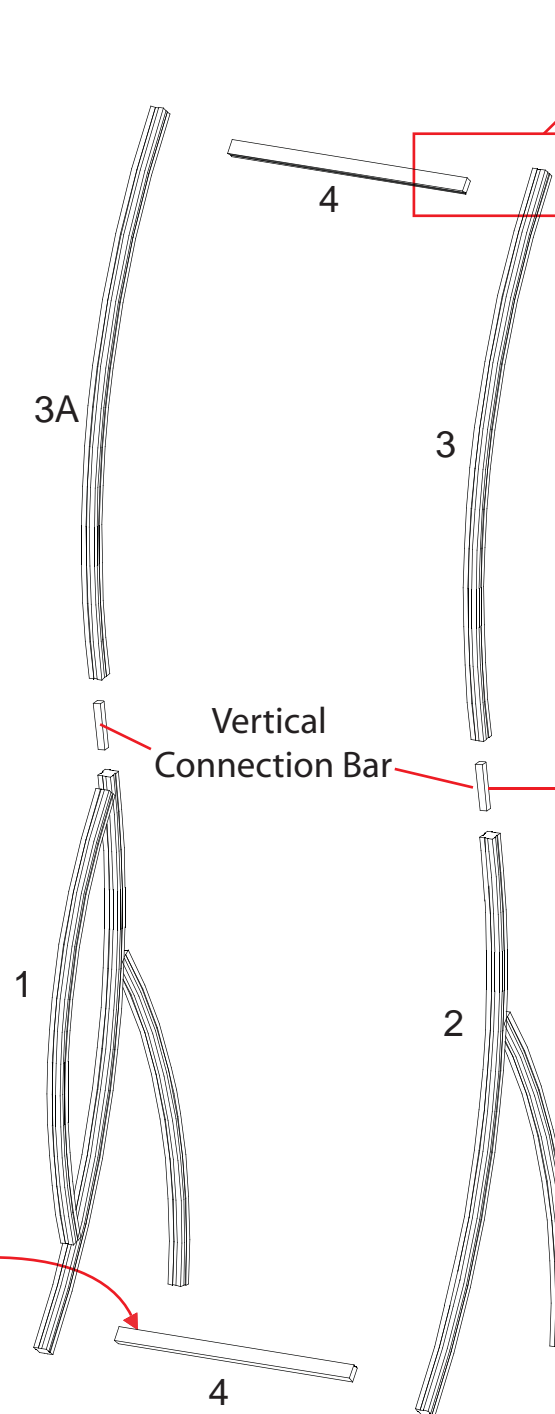

NOTE: When assembling horizontals they should be placed approximately one inch from TOP and BOTTOM.

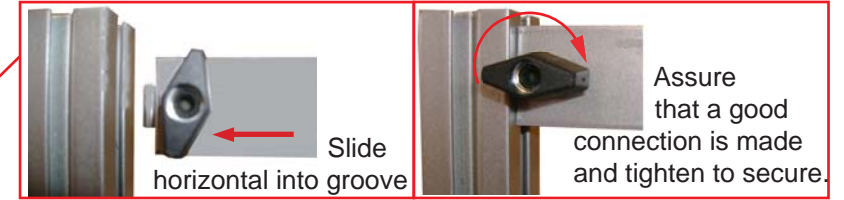

Slide Connection Bar into lower leg assembly. Slide upper vertical over bar and secure both.

Step stool may be required for assembly.



WHEN DISASSEMBLING TIGHTEN ALL BLACK KNOBS TO PREVENT LOSS DURING SHIPPING

866.652.2100

Part Number	Description
5	Right Leg Assembly w/ A10 Clamps Attached
6	Upper Curved Vertical w/ A10 Clamps Attached
7	69" w Horizontal w/ Hinge Facing UP
8	69" w Horizontal w/ Hinge Facing DOWN

Step 2

Step 2:

NOTE: Can be assembled either face down on floor then lifted upright or upright as shown in drawings.

- A) Connect vertical extrusion [6] to leg assembly [5] using vertical connection bar as shown.
- B) Connect horizontal extrusions [7 and 8] between vertical assemblies by tightening BLACK knobs on backside of extrusion making sure Velcro faces toward BACK.

NOTE: Make sure the lock is flush with extrusion before tightening. If lock will not fully engage, gently rock lock and extrusion while turning knob until lock fully opens.



NOTE: When assembling horizontals they should be placed approximately one inch from TOP and BOTTOM.

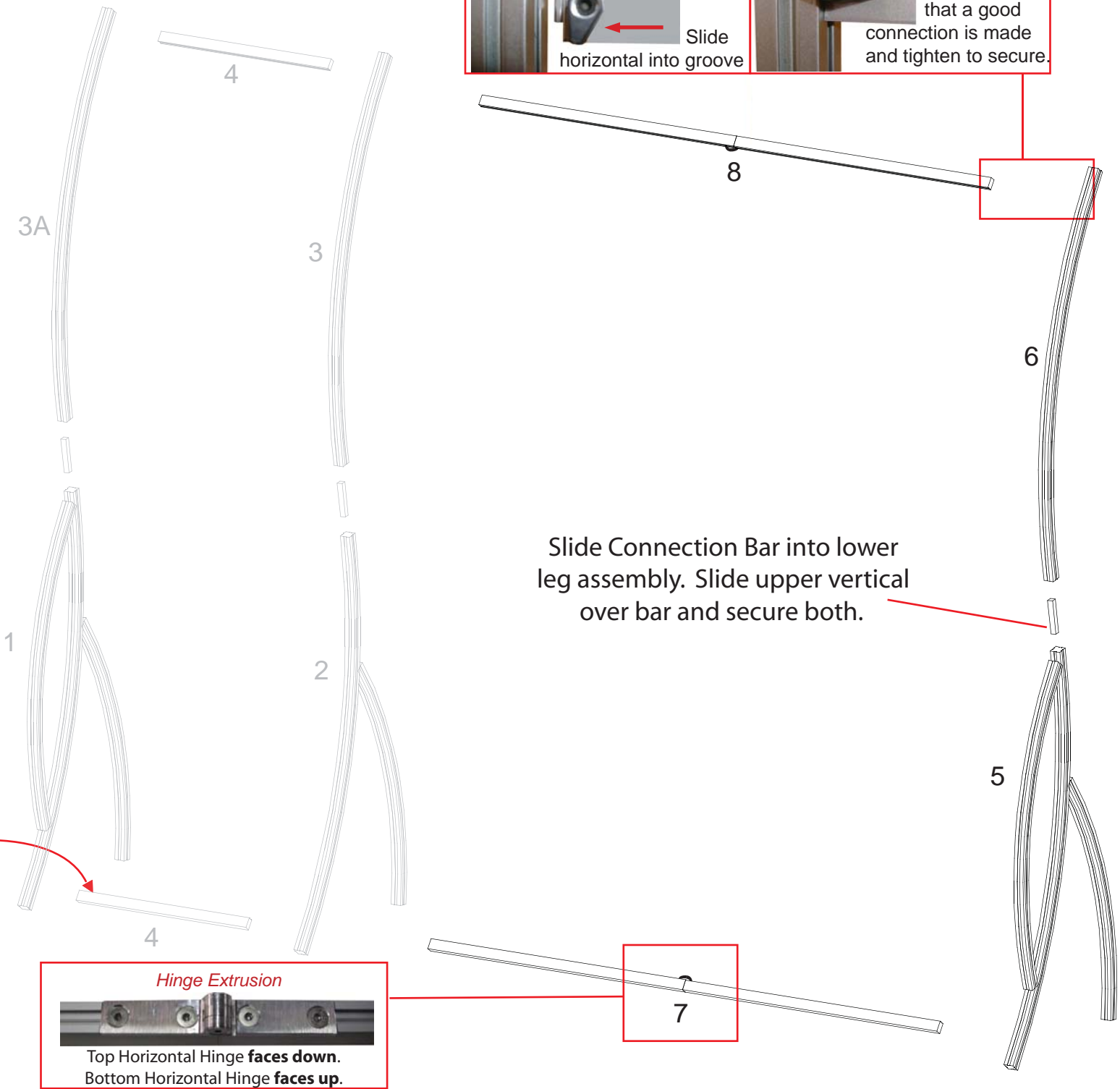
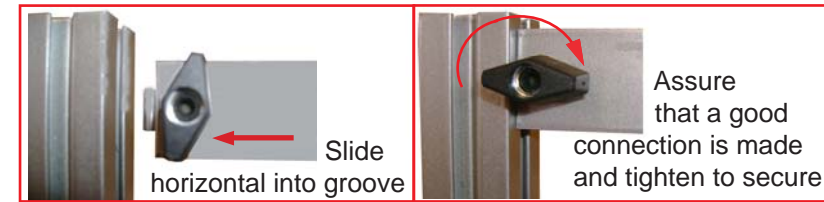

Rear View of Display

STAR indicates location of knobs on BACKSIDE of unit.

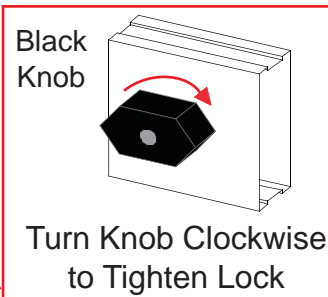

Slide Connection Bar into lower leg assembly. Slide upper vertical over bar and secure both.

WHEN DISASSEMBLING TIGHTEN ALL BLACK KNOBS TO PREVENT LOSS DURING SHIPPING

Attach blades to A10's attached to Backwall as shown.

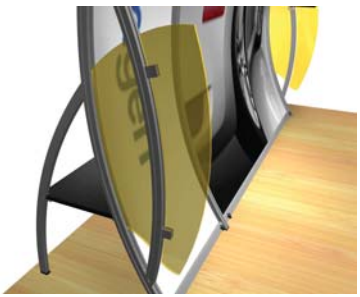

Decorative Blade Attachment (if accidentally removed)
Slide A10 Clamp into groove of square extrusion.

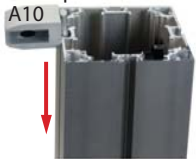

When desired location is found, tighten set screw to secure.





Set-Screw

Tighten black plastic set screw to secure Wing in place.



Black Plastic Set-screw

Hex Key Tool

(if necessary)

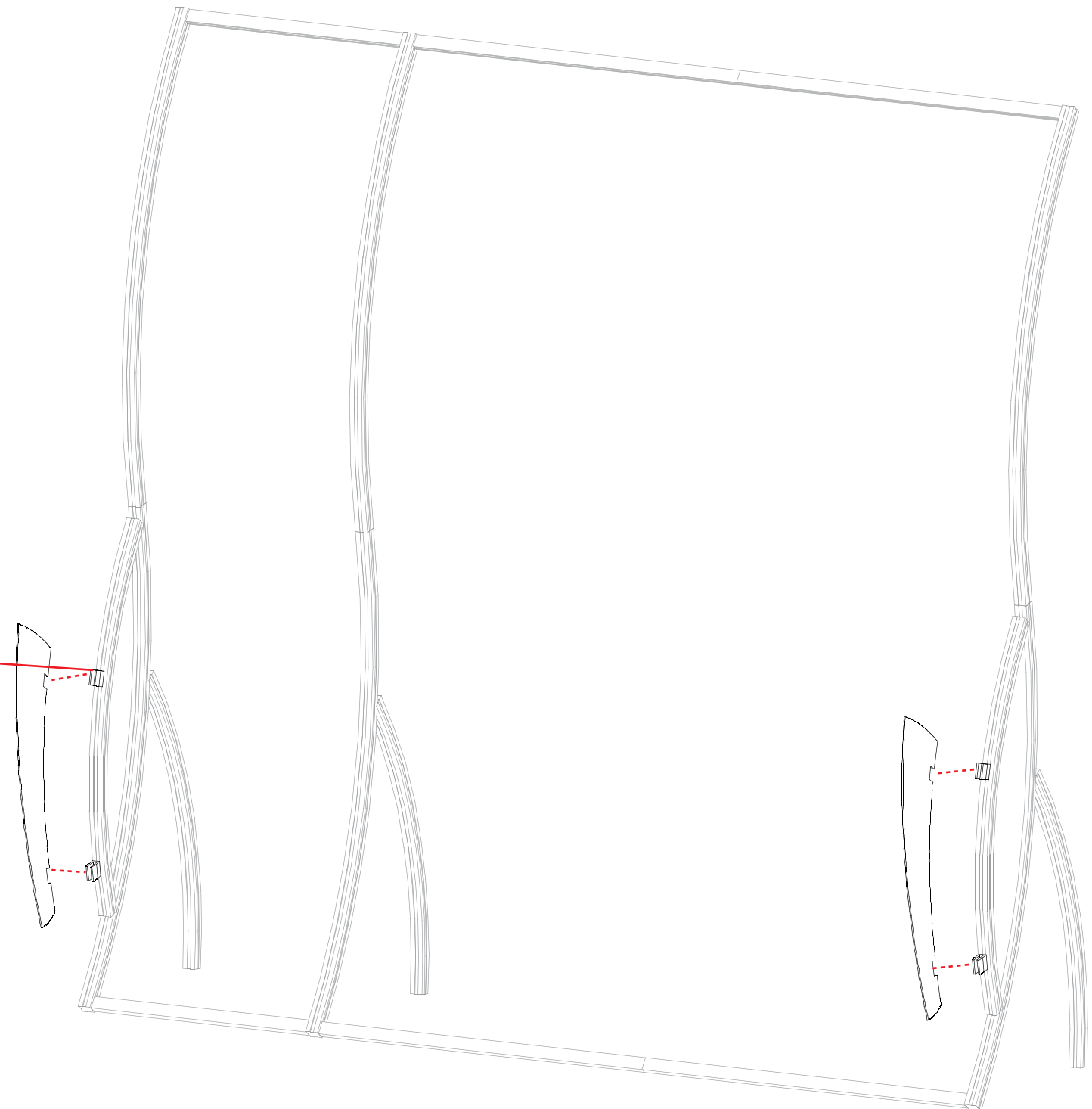
Flathead Screwdriver



WHEN DISASSEMBLING TIGHTEN ALL BLACK KNOBS TO PREVENT LOSS DURING SHIPPING

866.652.2100

Accessory Attachment
Attach Header support
then Slide header into Groove

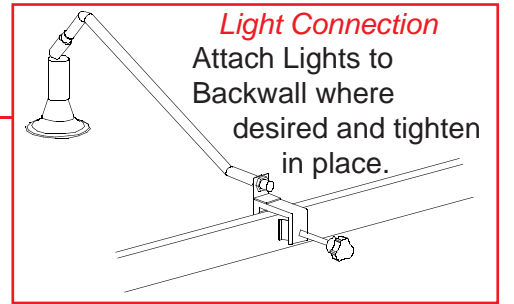
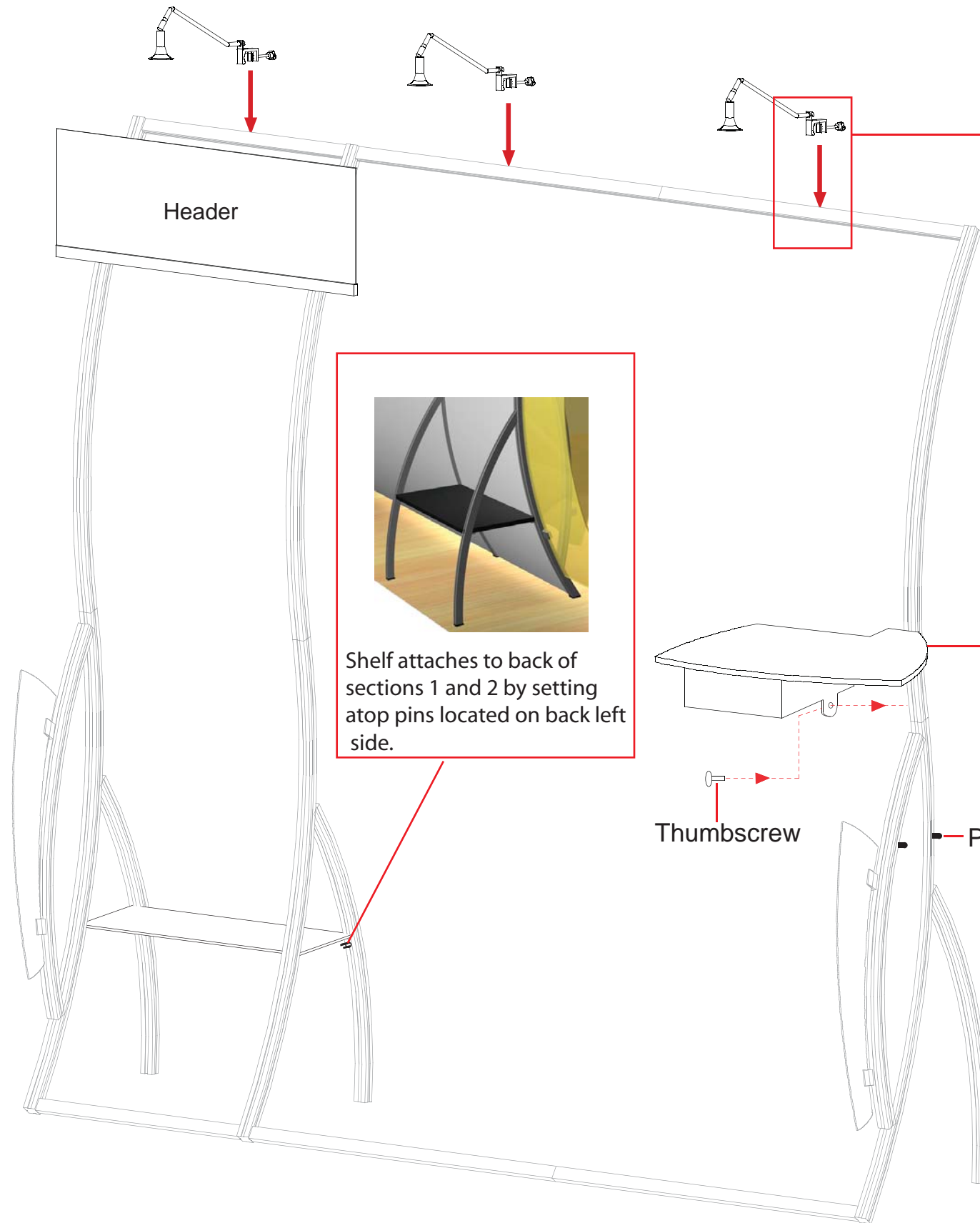
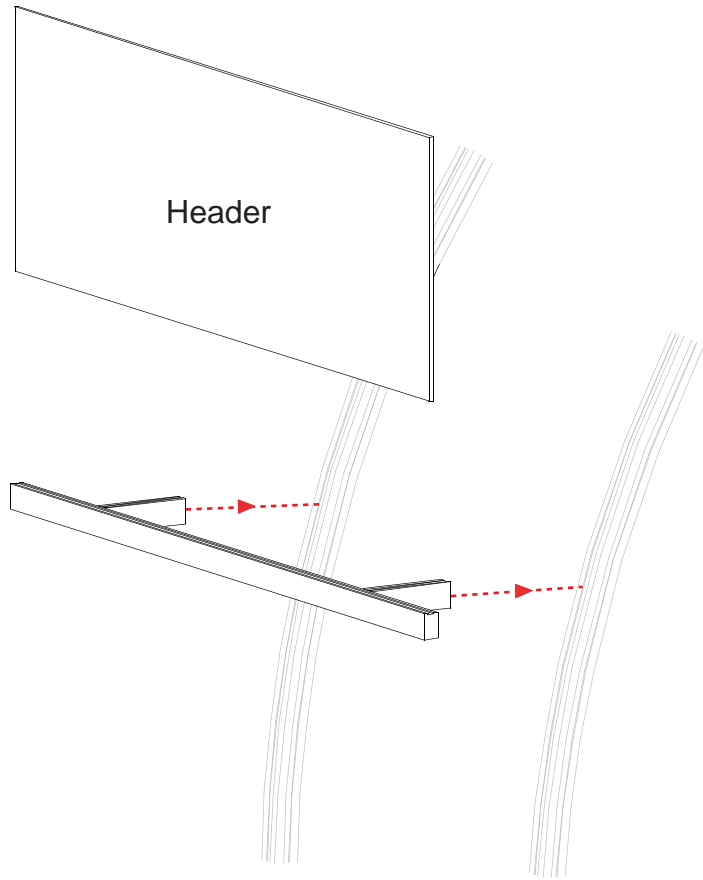

Light Connection
Attach Lights to
Backwall where
desired and tighten
in place.



Shelf attaches to back of
sections 1 and 2 by setting
atop pins located on back left
side.



Cubby Attachment

Shelf attaches to section
5 by setting atop pins
located on right side
and securing into place
with thumbscrew on left.



When attaching counter you will need to first
slide shelf onto back pin then set down on front
pin.

WHEN DISASSEMBLING TIGHTEN ALL BLACK KNOBS TO PREVENT LOSS DURING SHIPPING

866.652.2100

Part Number	Description
A	Left Leg Assembly
B	Right Leg Assembly
C	Horizontal Extrusion
D	Horizontal Extrusion w/ Door Stopper

- Step 1:
- A) Connect lower horizontal extrusion [C] between bottom of leg assemblies [A and B] as shown.
 - B) Insert Laminated infill into grooves of leg assemblies [A and B].
 - C) Attach extrusion door between leg assemblies [A and B] and atop laminated infill.
 - D) Attach upper horizontal extrusion w/ door stopper [D] between leg assemblies [A and B], and set flush with top of legs [A and B].

NOTE: Make sure the lock is flush with extrusion before tightening. If lock will not fully engage, gently rock lock and extrusion while turning knob until lock fully opens.

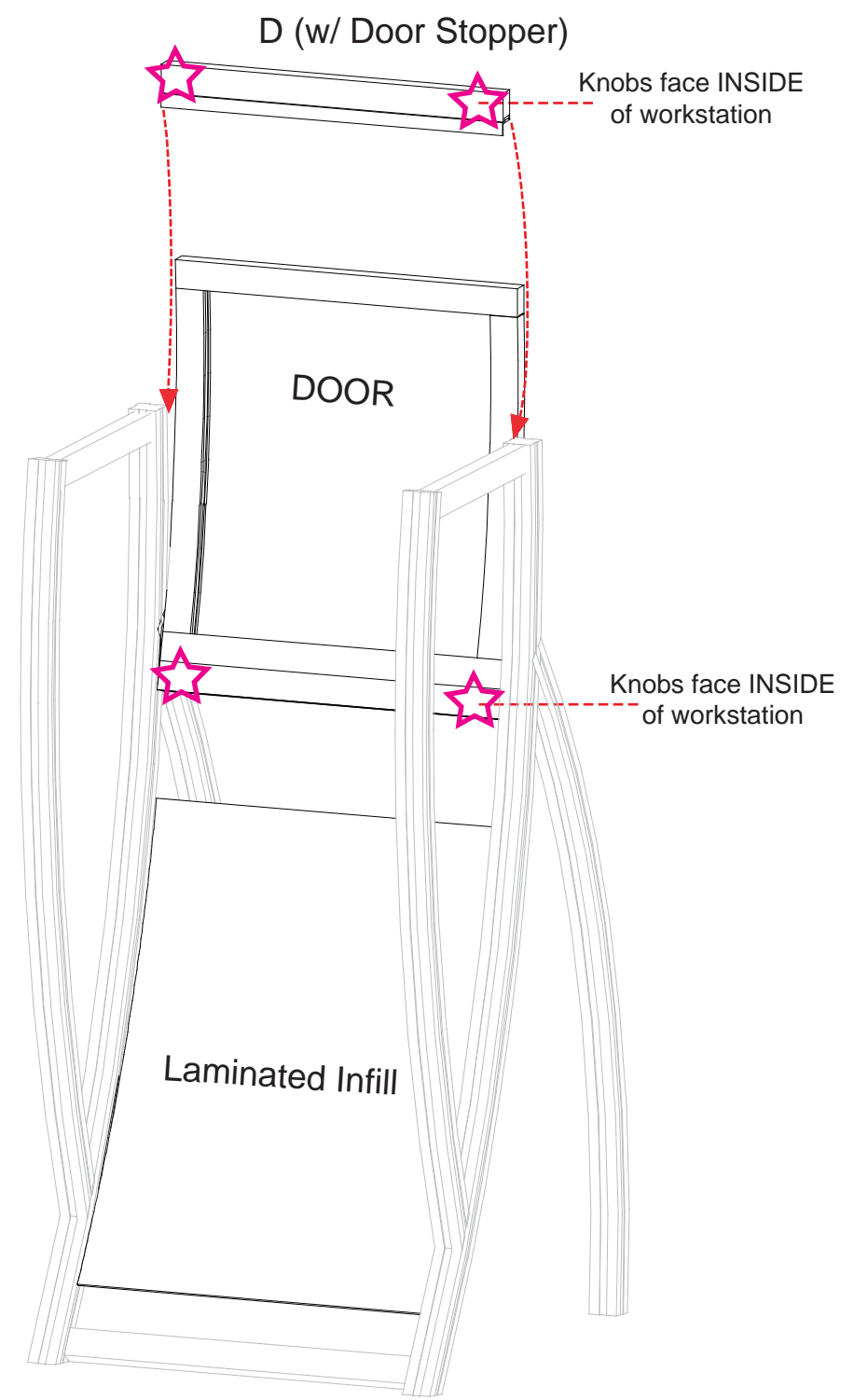
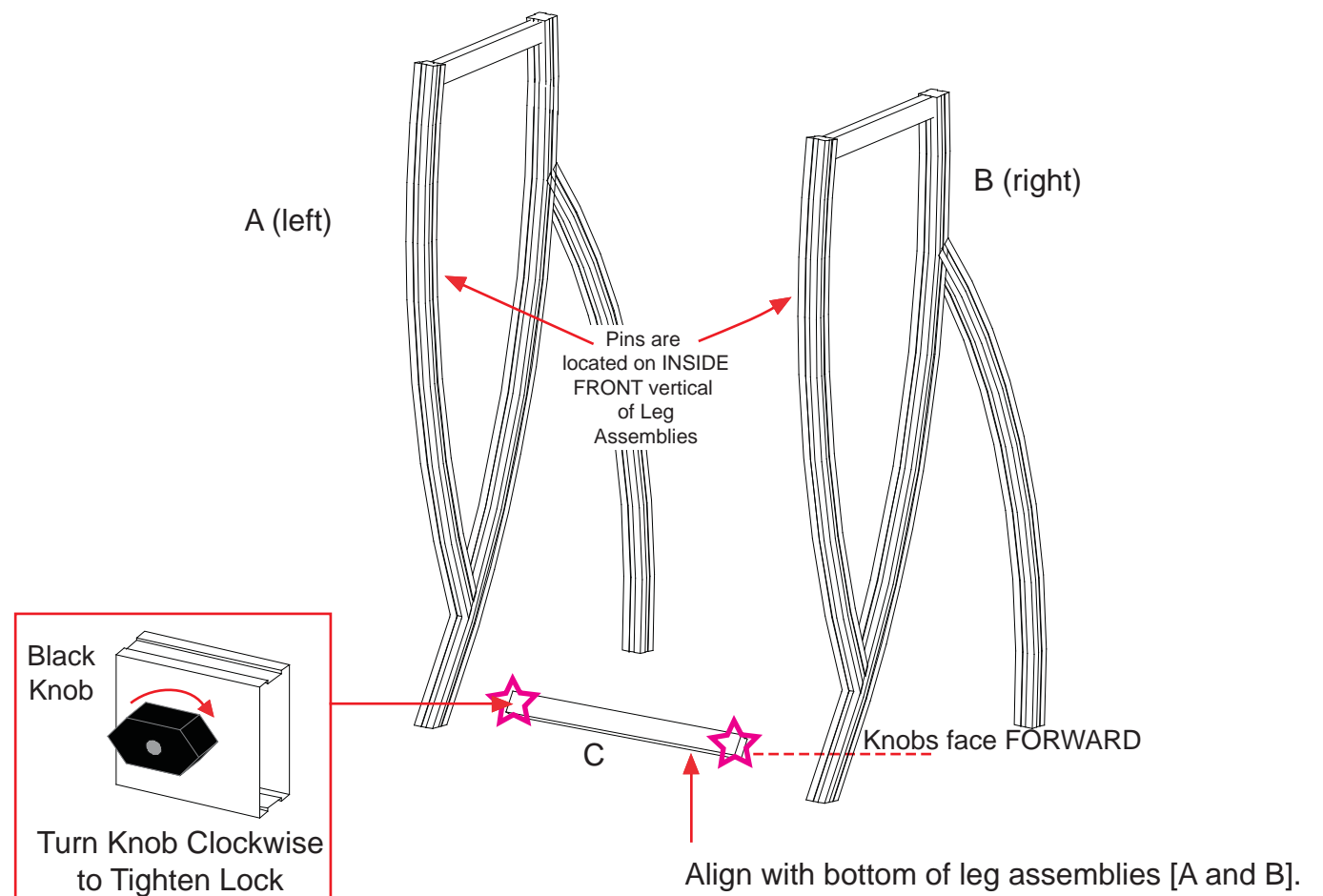

WHEN DISASSEMBLING TIGHTEN ALL BLACK KNOBS TO PREVENT LOSS DURING SHIPPING

Part Number	Description
E	Horizontal Extrusion
F	Horizontal Extrusion

Step 2:

- A) Attach horizontal extrusion [E] between vertical leg assemblies [A and B] as shown below.
- B) Insert Laminated infill into grooves of vertical leg assemblies [A and B].
- C) Attach upper horizontal extrusion [F] between vertical leg assemblies [A and B] atop infill.
- D) Place internal shelf into assembled pedestal atop pins.
- E) Set Counter atop assembled pedestal and secure with Velcro straps attached to underside of top.

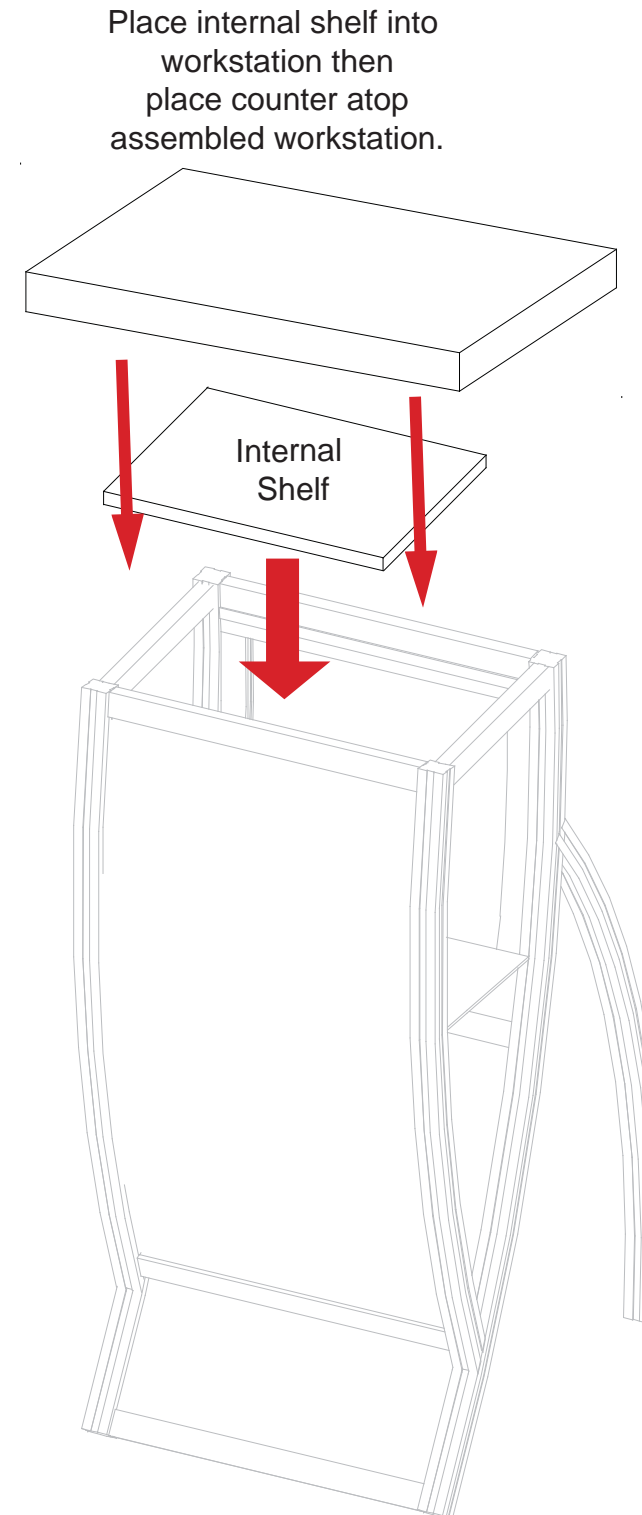
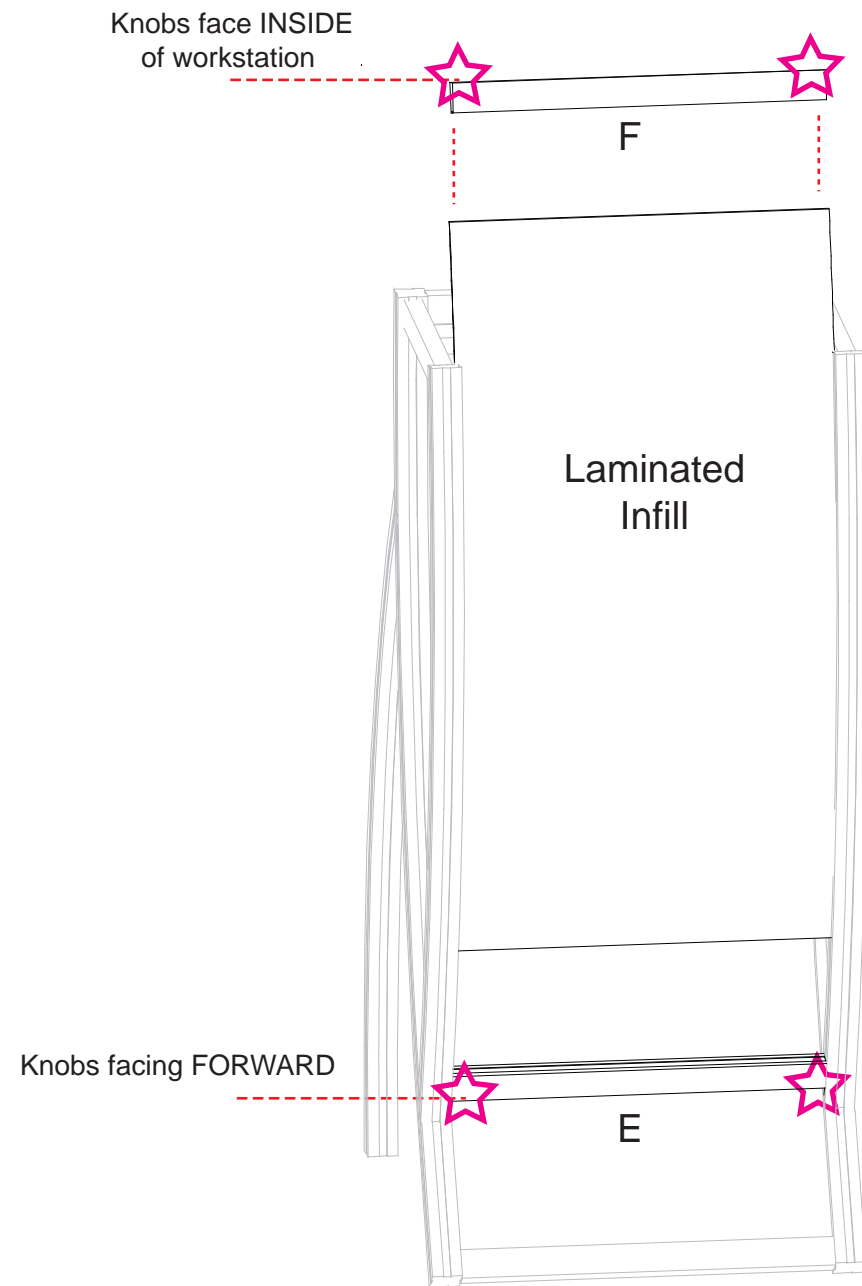

WHEN DISASSEMBLING TIGHTEN ALL BLACK KNOBS TO PREVENT LOSS DURING SHIPPING

866.652.2100

Part Number	Description
G	Curved Montior Mount Extrusion

Step 3:

- A) Slide Connection Bar into lower leg assembly. Slide upper vertical over bar and secure both.
- B) Attach Monitor Mount to vertical as shown in Detail below.

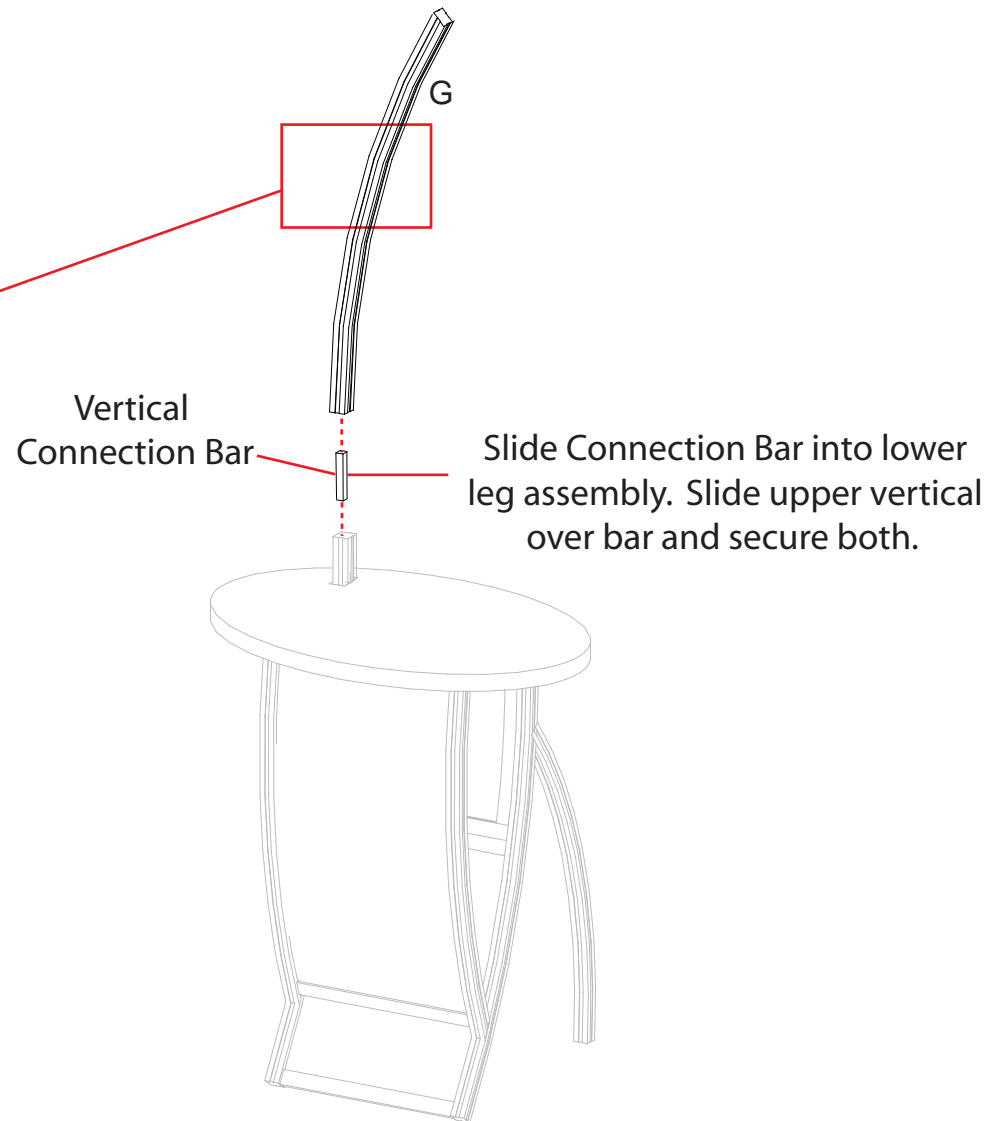
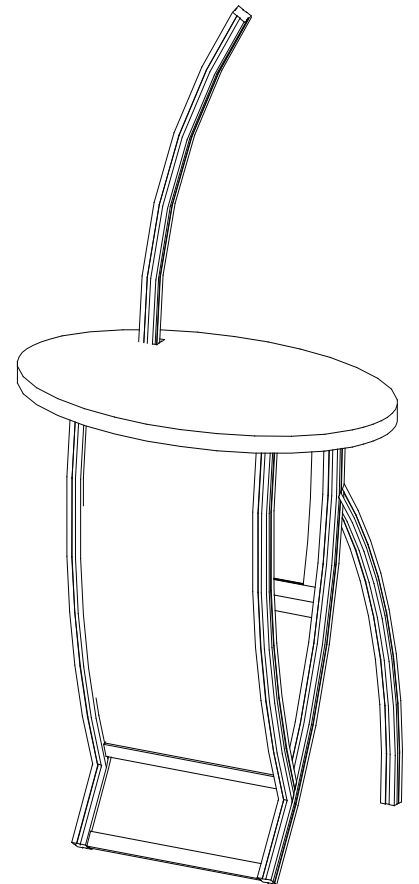

MONITOR MOUNT
Attach monitor mount to vertical extrusions after assembly.

Slide Mount into Groove of Vertical Extrusion.
Tighten Setscrew
Attach top Plate and tighten screws

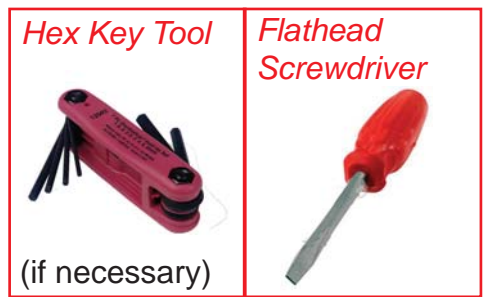

WHEN DISASSEMBLING TIGHTEN ALL BLACK KNOBS TO PREVENT LOSS DURING SHIPPING

Case #1 - Backwall Components

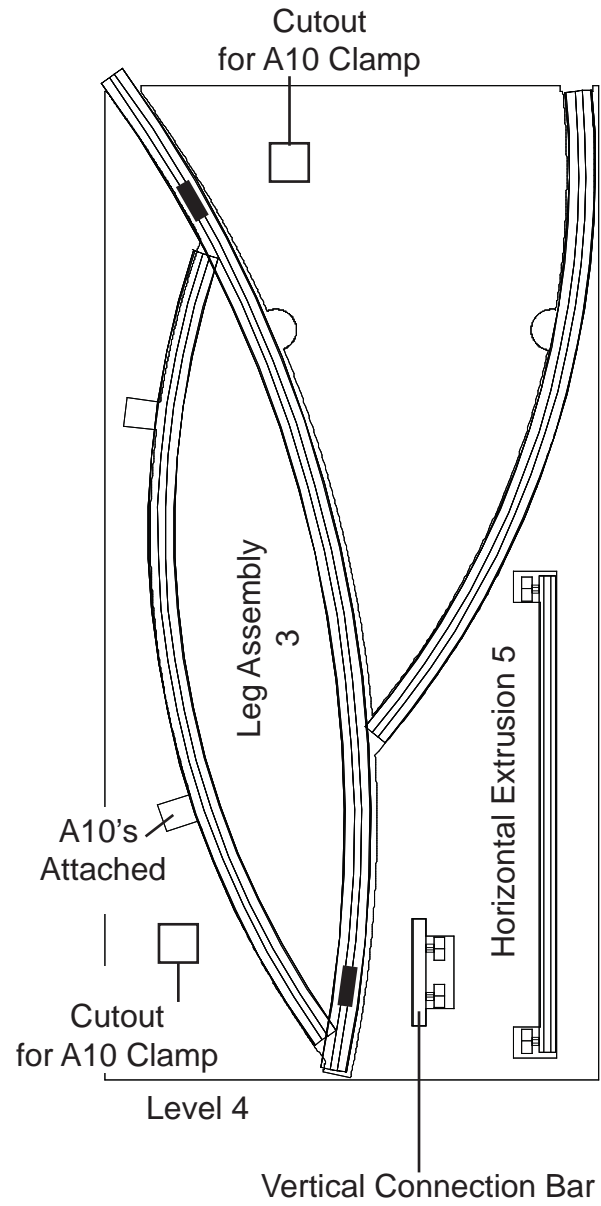
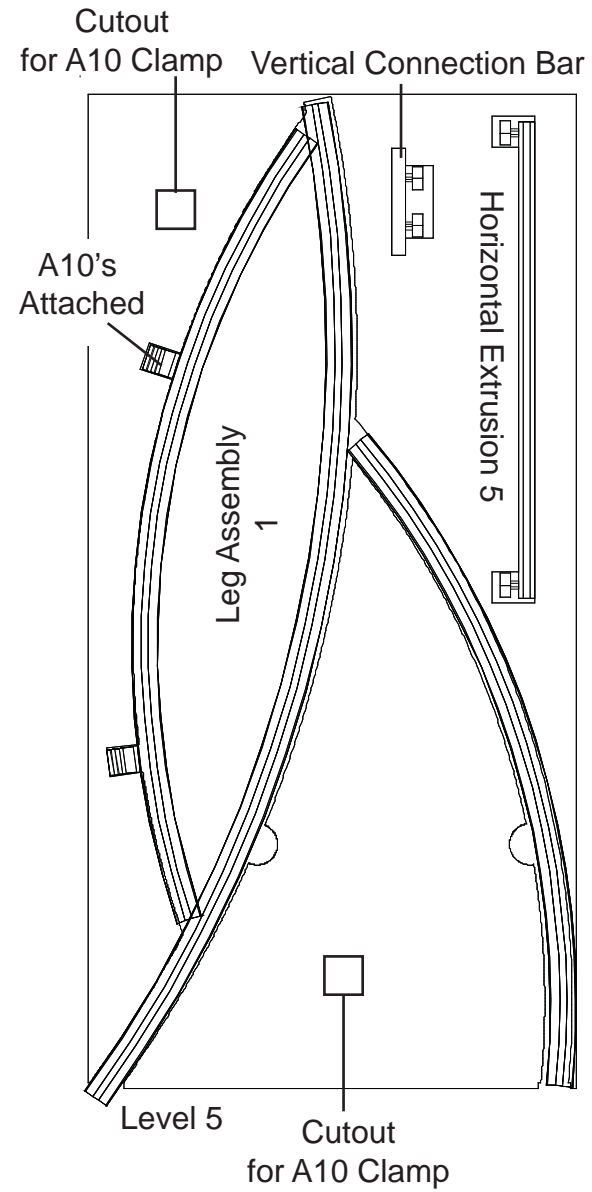

Top View of each Level

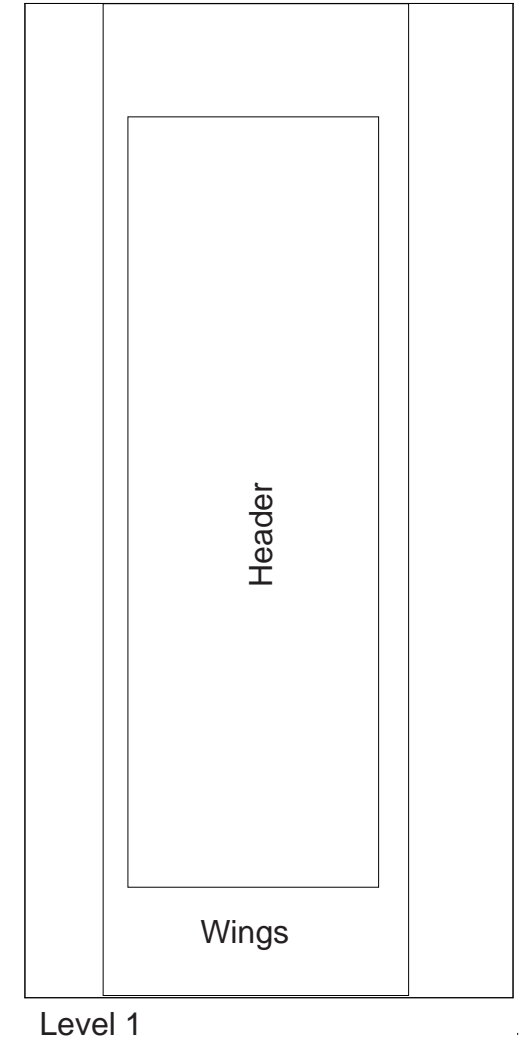
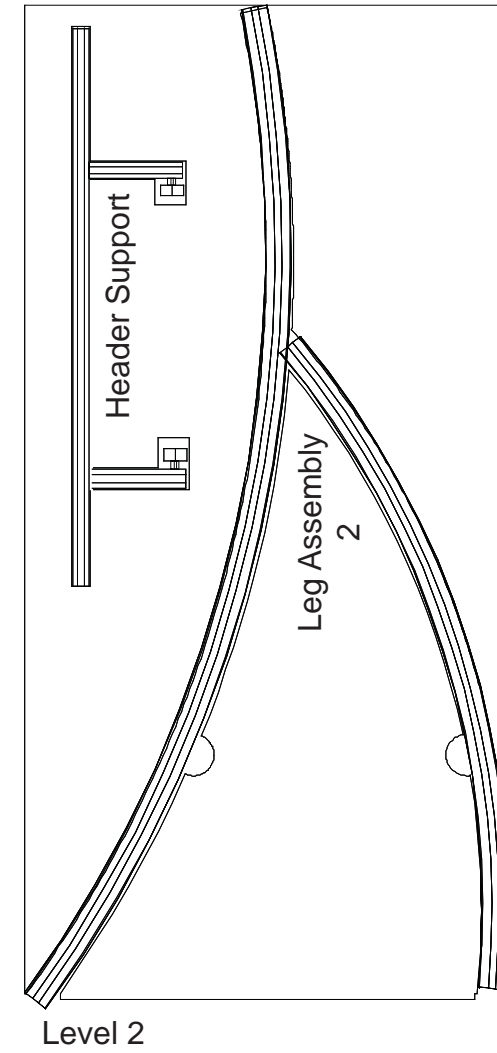
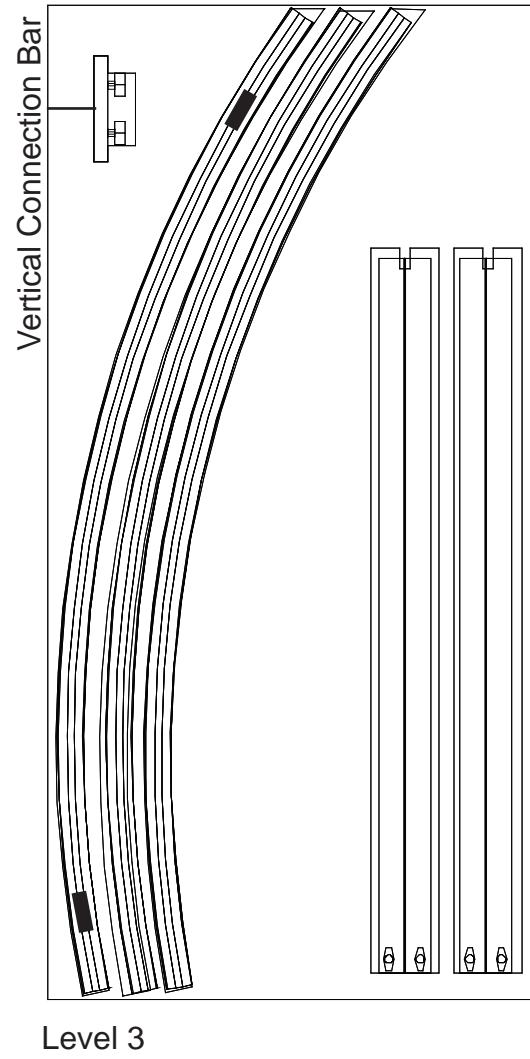

WHEN DISASSEMBLING TIGHTEN ALL BLACK KNOBS TO PREVENT LOSS DURING SHIPPING

Case #2 - Backwall Components

Top View of each Level

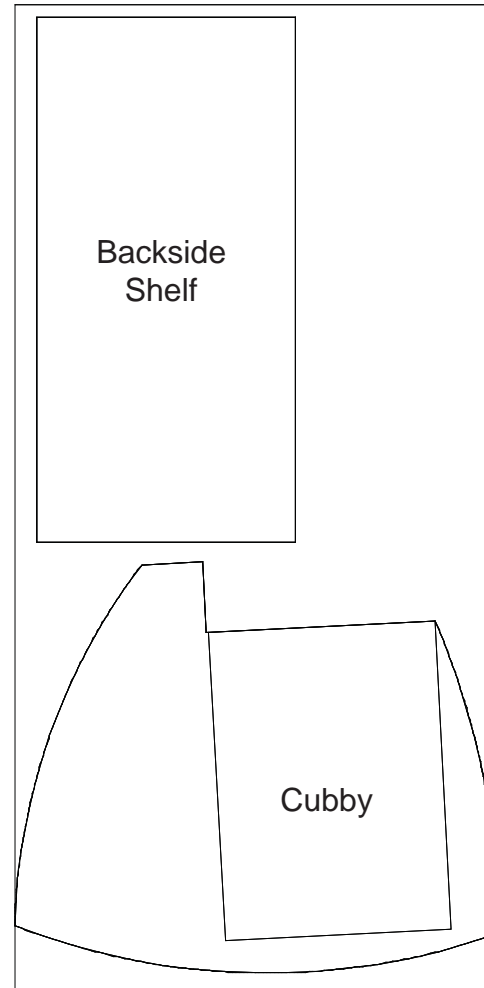

Level 1

WHEN DISASSEMBLING TIGHTEN ALL BLACK KNOBS TO PREVENT LOSS DURING SHIPPING

Case #3 - Workstation Components

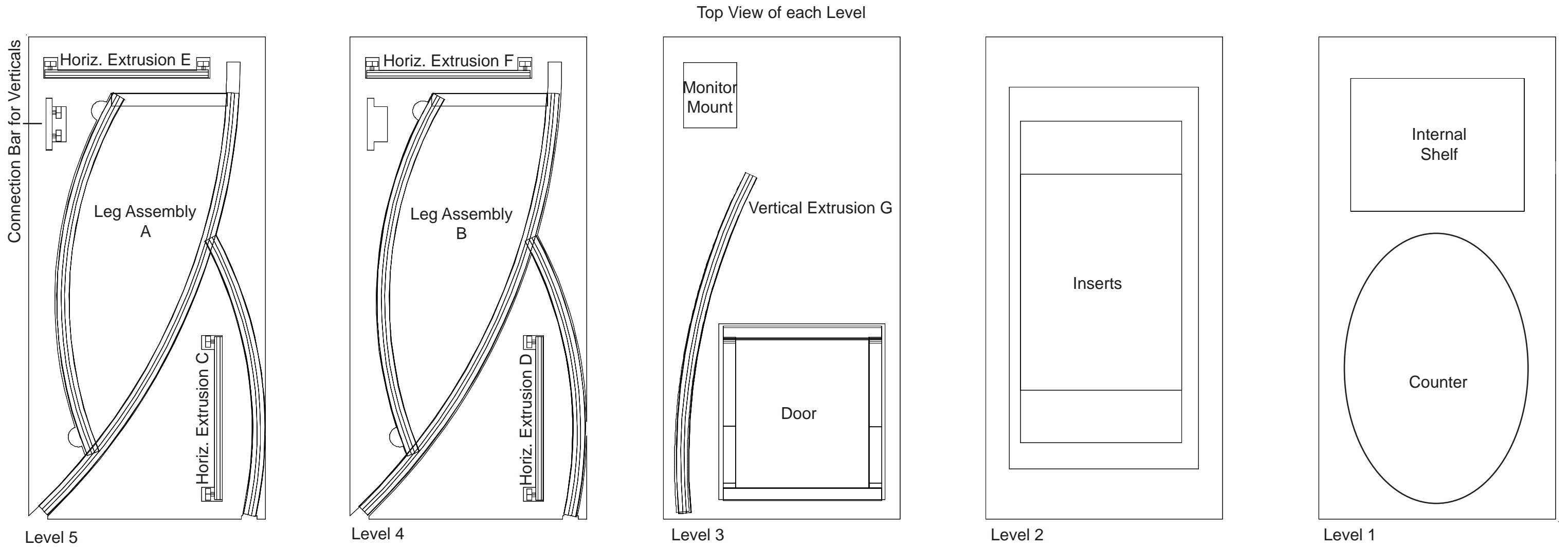

WHEN DISASSEMBLING TIGHTEN ALL BLACK KNOBS TO PREVENT LOSS DURING SHIPPING