



Part Number	Qty for Step	Description
31	1	Base Plate
32	1	72" h Half Round Vertical extrusion
33	1	Base Plate
34	1	72" h Half Round Vertical extrusion
35	2	36" h Lower Horizontal extrusion
36	2	36" h Upper Horizontal extrusion

Steps

- 1) Connect base plates [31 and 33] to vertical extrusions [32 and 34].
 - 2) Connect horizontal extrusions [35 and 36] between vertical extrusions [32 and 34] as shown.
 - 3) Place lights staggered inside the vertical extrusions making sure to run cords down thru bottom opening.
- NOTE: Lights are pigtailed together in two's.
- 4) Attach Header to Sintra Cap and place atop assembled lightbox.

Repeat Steps for all 3 units.

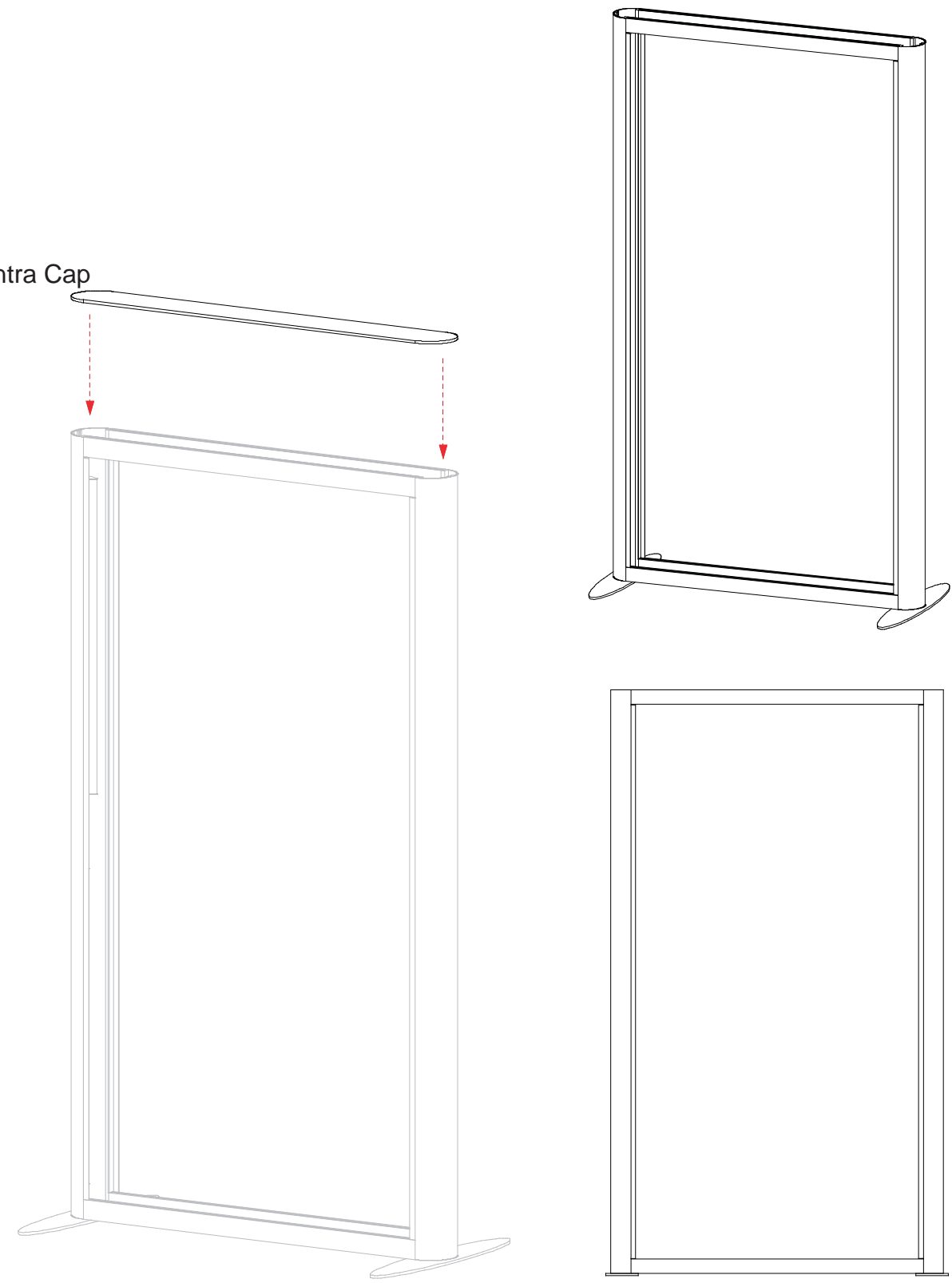
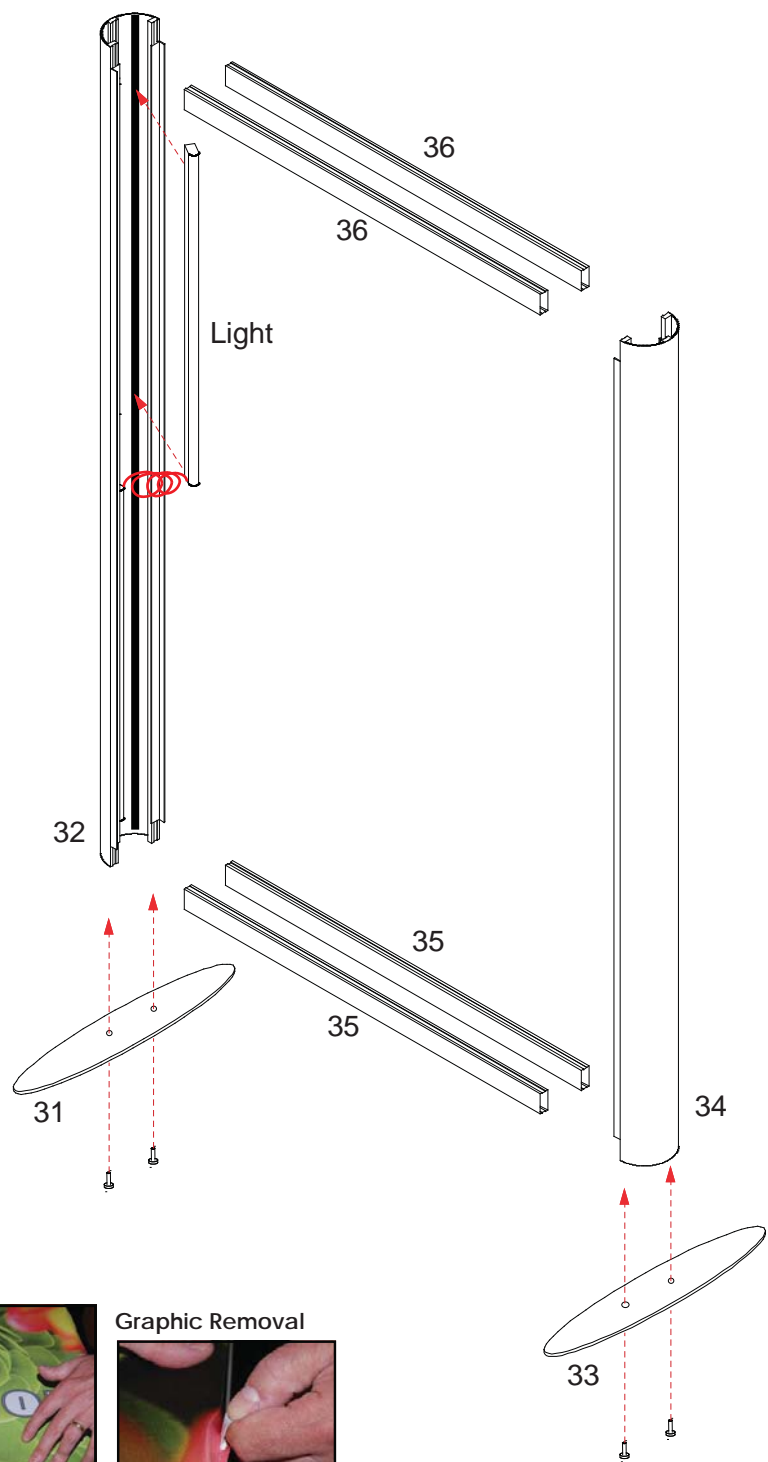

Graphic: To Ensure Proper Fit

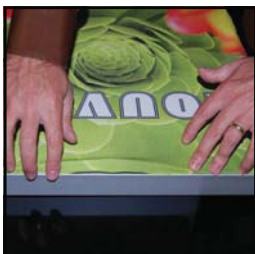
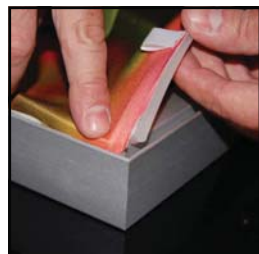
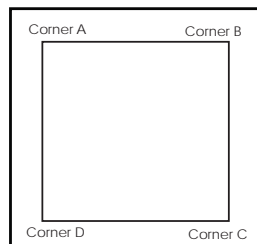

It is important to first insert graphic into each alternate corner then to the sides of the frame. If this is not done, graphic will not fit into the frame correctly.

Step 1
Insert corner A. Turn edge of graphic so silicon welt is perpendicular to face of graphic. Insert narrow side of welt with fabric to outside into the channel. Repeat for other side of this corner.

Step 2
Repeat Step 1 for opposite corner C, then insert corner B, followed by corner D, to complete the installation of the corners.

Step 3
Once all corners are inserted, press one silicon edge into channel from corners and work toward the center. Make sure welt is fully inserted into channel. Continue until all sides are done. Smooth out edges of graphic.

To remove the graphic from the frame, locate the fabric pull tab. Gently pull up on the tab to remove the fabric.

WHEN DISASSEMBLING ALUMINUM EXTRUSION, TIGHTEN ALL SETSCREWS AND LOCKS TO PREVENT LOSS DURING SHIPPING

visionary™ DESIGNS

Using Your Setup Instructions

The Visionary Designs Setup Instructions are created specifically for your configuration. They are laid out sequentially, including an exploded view of the entire display, and then a logical series of detailed steps to assemble the main structure and components. We encourage you to study the instructions **before** attempting to assemble your exhibit.

Each page reminds you to tighten the setscrews after disassembling your exhibit to prevent loss of the locks and setscrews (see below in RED). This is VERY IMPORTANT.

Cleaning and Packing Your Display

- 1) Use care when cleaning aluminum extrusion or acrylic inserts. Use only non-abrasive cleaners.
- 2) When cleaning laminate inserts or countertops, use mild cleansers and a soft material such as cotton.
- 3) Keep all display components away from extreme heat and long exposure to sunlight to avoid warping and fading.
- 4) Retain all packing material. It will make re-packing much easier and will reduce the likelihood of shipping damage.



The Tool

Most Visionary Designs exhibits can be assembled with the supplied Hex Key Tool. Occasionally, a flat head screwdriver may be required.



Typical Connection

Most horizontal extrusion connections have a patented expandable lock. This lock inserts into the groove of an opposing extrusion. Tightening the lock with the Hex Key Tool expands the lock and creates a strong positive connection.



Typical Connection (cont'd)

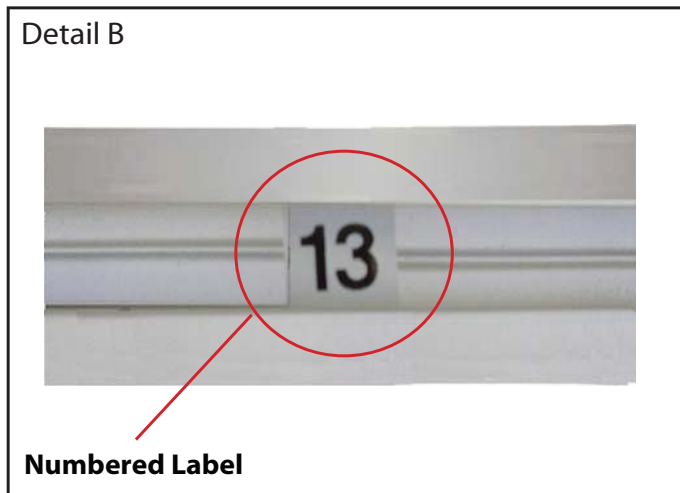

Numbered Label

Each extrusion contains a numbered label which corresponds with setup instructions. The label is located within a groove of the extrusion (when possible). With Visionary Designs the labels contain Black numbers unless otherwise specified.



Horizontal Inline Connection (remove only one setscrew)

Remove only (1) setscrew when disassembling. Replace setscrew in extrusion after assembling it. Before packing, replace setscrew in extrusion to avoid losing it.

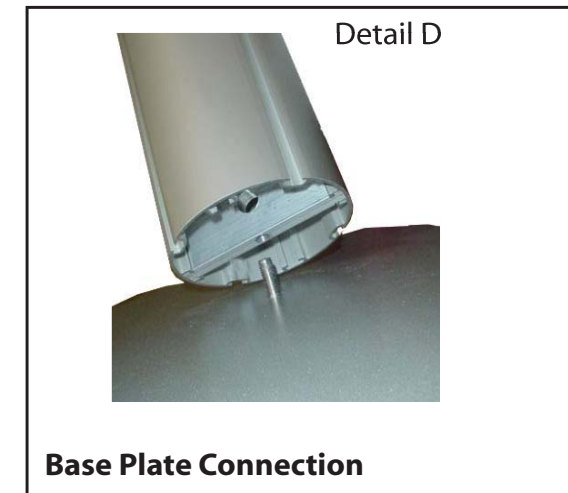

Base Plate Connection

Attach base plate to round or square vertical extrusion using the bolt provided. Be careful not to strip the threads.

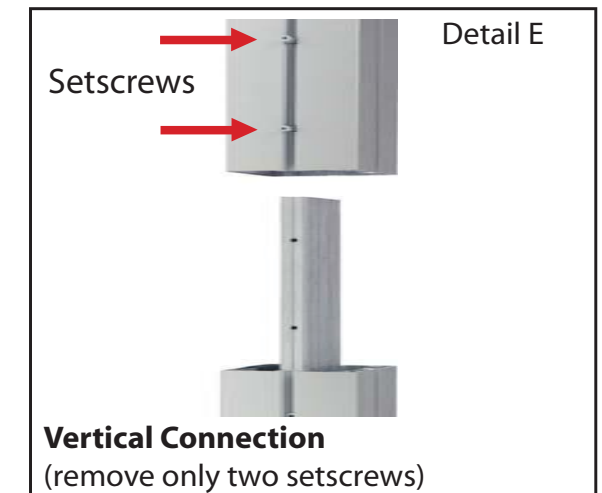

Vertical Connection (remove only two setscrews)

When vertical extrusions are packed in portable cases rather than crates or tubs, they must be broken down into smaller sections which then require assembly.

Remove only (2) setscrews when disassembling. Replace setscrews in extrusion after assembling it. Before packing, replace setscrews in extrusion to avoid losing them.

WHEN DISASSEMBLING ALUMINUM EXTRUSION, TIGHTEN ALL SETSCREWS AND LOCKS TO PREVENT LOSS DURING SHIPPING