

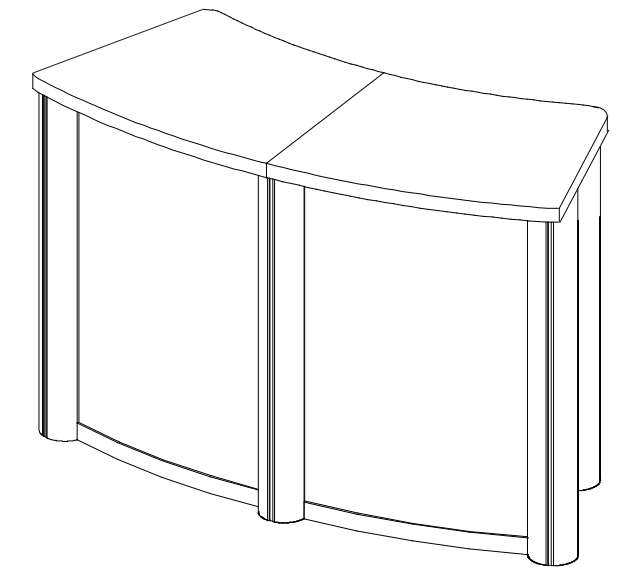

| Item | Qty. | Description                             |
|------|------|---|
| 1    | 1    | 38" h Vertical Extrusion                |
| 2    | 1    | 38" h Vertical Extrusion                |
| 3    | 1    | 38" h Vertical Extrusion                |
| 4    | 1    | 38" h Vertical Extrusion w/ Door Hinges |
| 5    | 1    | 38" h Vertical Extrusion w/ Door Stops  |
| 6    | 1    | 38" h Vertical Extrusion w/ Door Hinges |
| 7    | 4    | 16.5" Curved Horizontal Extrusion       |
| 8    | 4    | 22.95" Curved Horizontal Extrusion      |
| 9    | 4    | 11.5" Horizontal Extrusion              |

Steps:

- 1) Attach lower horizontal extrusions [7, 8 and 9] between vertical extrusions [1, 2, 3, 4, 5 and 6].
- 2) Place inserts and attach doors where indicated.
- 3) Attach upper horizontal extrusions [7, 8 and 9] between vertical extrusions [1, 2, 3, 4, 5 and 6] and atop doors and inserts.
- 4) Velcro shelf supports to inside of assembled pedestal, then set internal shelves atop supports.
- 5) Place counter top on assembled pedestal.

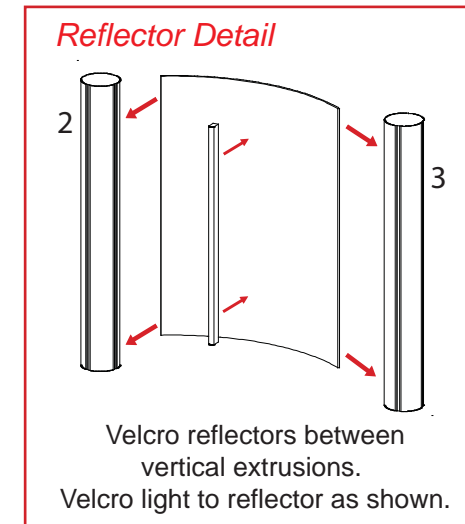
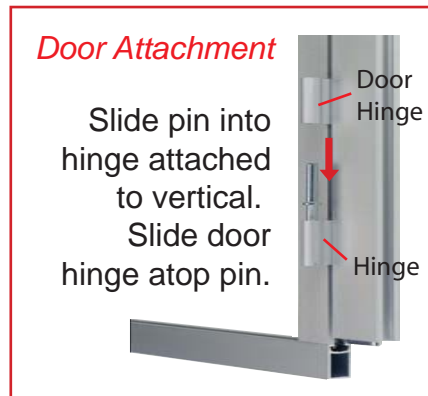

**Note:** Internal Shelves are marked with an "L" or an "R" indicating left or right positions otherwise they will not fit properly.

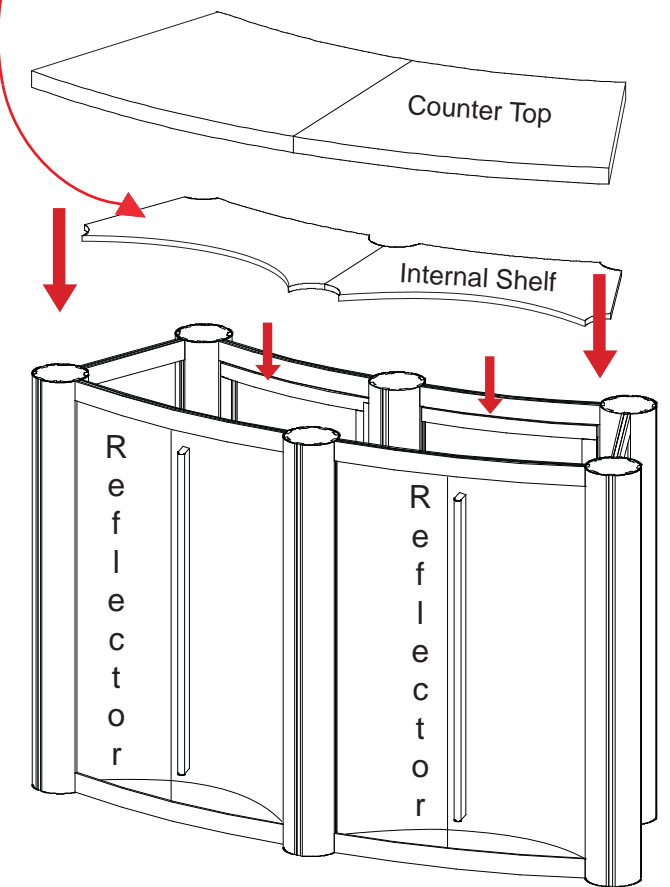
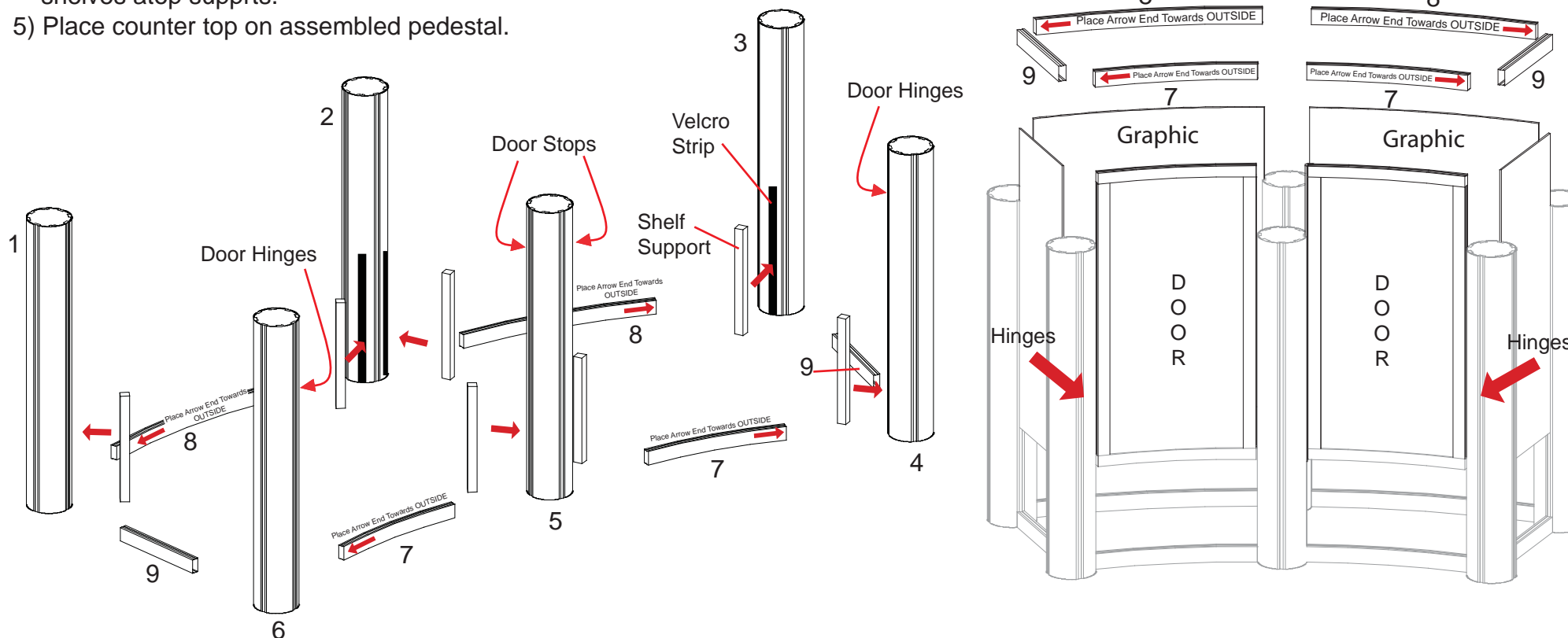

**WHEN DISASSEMBLING ALUMINUM EXTRUSION, TIGHTEN ALL SETSCREWS AND LOCKS TO PREVENT LOSS DURING SHIPPING**

# visionary™ DESIGNS

## Using Your Setup Instructions

The Visionary Designs Setup Instructions are created specifically for your configuration. They are laid out sequentially, including an exploded view of the entire display, and then a logical series of detailed steps to assemble the main structure and components. We encourage you to study the instructions **before** attempting to assemble your exhibit.

Each page reminds you to tighten the setscrews after disassembling your exhibit to prevent loss of the locks and setscrews (see below in RED). This is **VERY IMPORTANT**.

## Cleaning and Packing Your Display

- 1) Use care when cleaning aluminum extrusion or acrylic inserts. Use only non-abrasive cleaners.
- 2) When cleaning laminate inserts or countertops, use mild cleansers and a soft material such as cotton.
- 3) Keep all display components away from extreme heat and long exposure to sunlight to avoid warping and fading.
- 4) Retain all packing material. It will make re-packing much easier and will reduce the likelihood of shipping damage.



**The Tool**

Most Visionary Designs exhibits can be assembled with the supplied Hex Key Tool. Occasionally, a flat head screwdriver may be required.



Detail A

**Typical Connection**



**Typical Connection (cont'd)**

Most horizontal extrusion connections have a patented expandable lock. This lock inserts into the groove of an opposing extrusion. Tightening the lock with the Hex Key Tool expands the lock and creates a strong positive connection.



Detail B

**Numbered Label**

Each extrusion contains a numbered label which corresponds with setup instructions. The label is located within a groove of the extrusion (when possible). With Visionary Designs the labels contain Black numbers unless otherwise specified.



Detail C

**Horizontal Inline Connection** (remove only one setscrew)

Remove only (1) setscrew when disassembling. Replace setscrew in extrusion after assembling it. Before packing, replace setscrew in extrusion to avoid losing it.

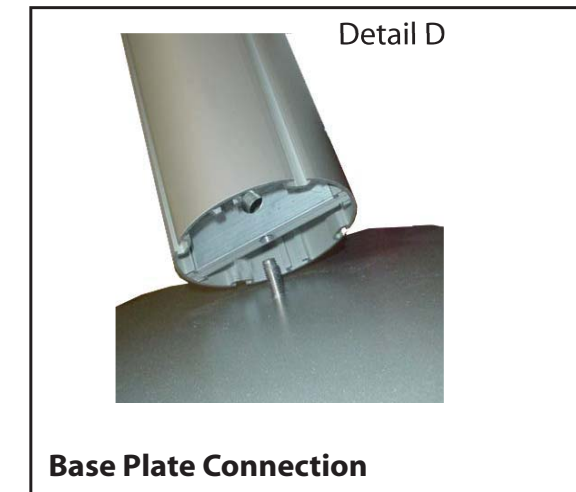

Detail D

**Base Plate Connection**

Attach base plate to round or square vertical extrusion using the bolt provided. Be careful not to strip the threads.



Detail E

**Vertical Connection**  
(remove only two setscrews)

When vertical extrusions are packed in portable cases rather than crates or tubs, they must be broken down into smaller sections which then require assembly.

Remove only (2) setscrews when disassembling. Replace setscrews in extrusion after assembling it. Before packing, replace setscrews in extrusion to avoid losing them.

**WHEN DISASSEMBLING ALUMINUM EXTRUSION, TIGHTEN ALL SETSCREWS AND LOCKS TO PREVENT LOSS DURING SHIPPING**

Case 1

Level 1

3 - 38" h Round Vertical Extrusions

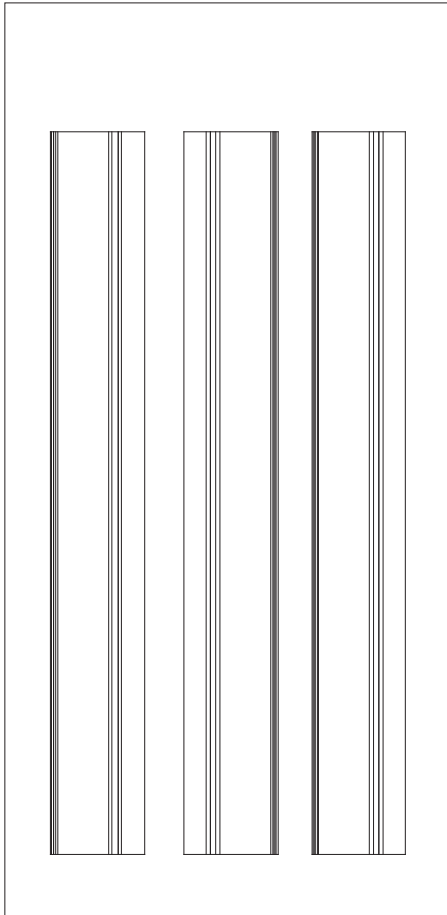

Level 2

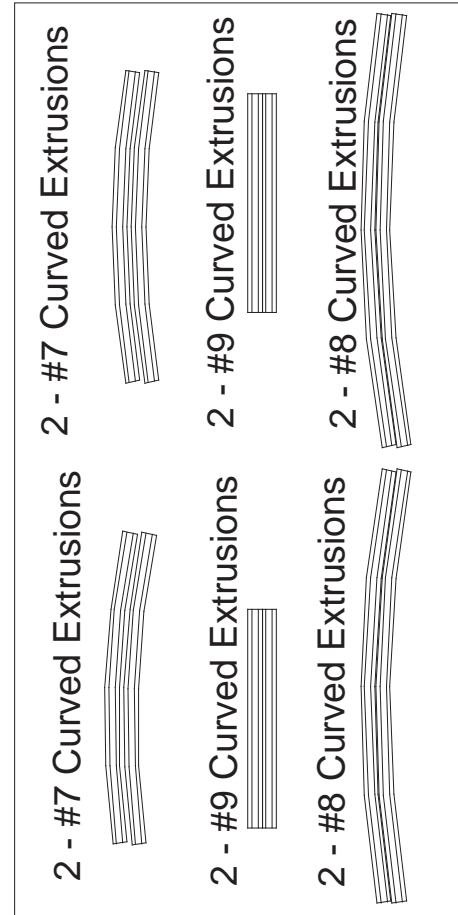

Level 3

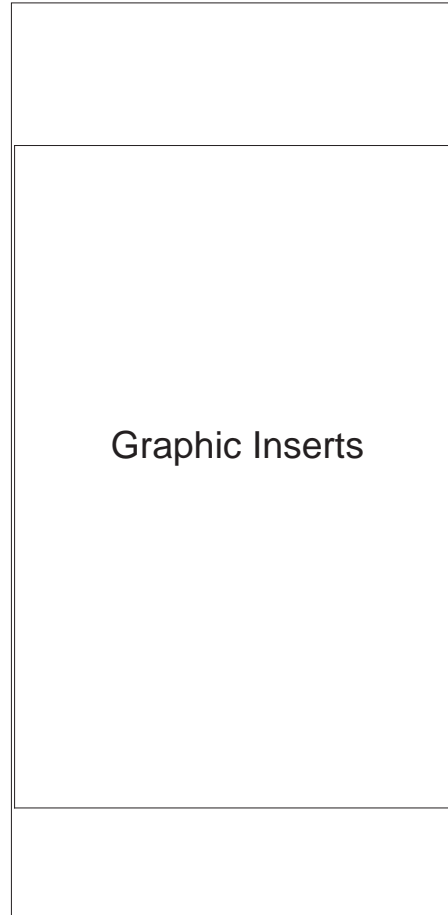

Level 4

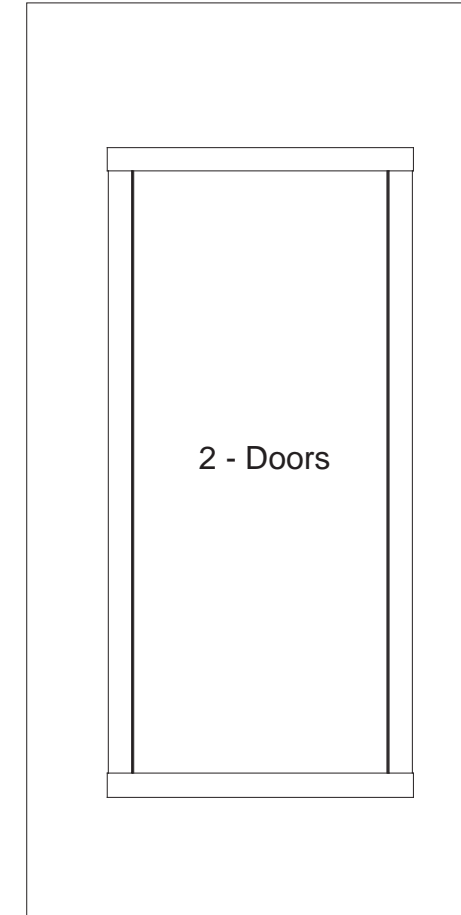

Additional Item  
- Setup Instruction

WHEN DISASSEMBLING ALUMINUM EXTRUSION, TIGHTEN ALL SETSCREWS AND LOCKS TO PREVENT LOSS DURING SHIPPING

Case 2

Level 1

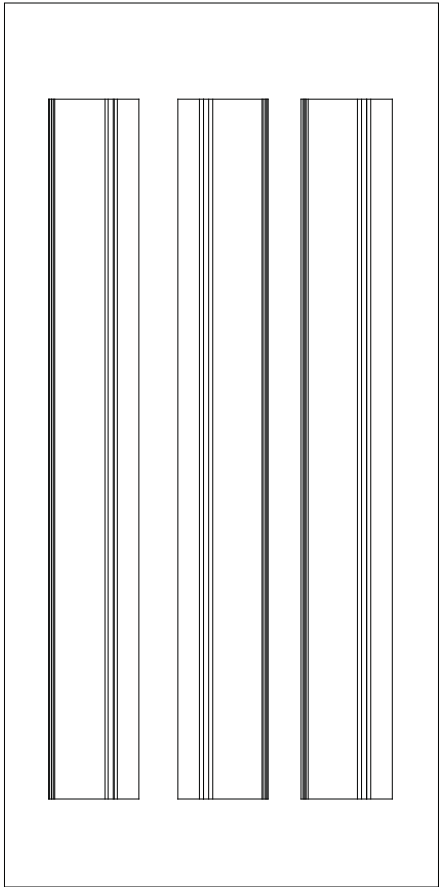

3 - 38" h Round Vertical Extrusions

Level 2

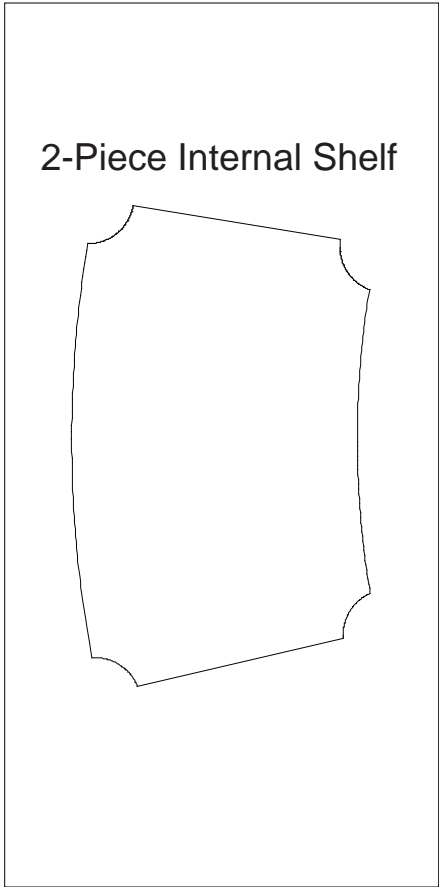

2-Piece Internal Shelf

Level 3

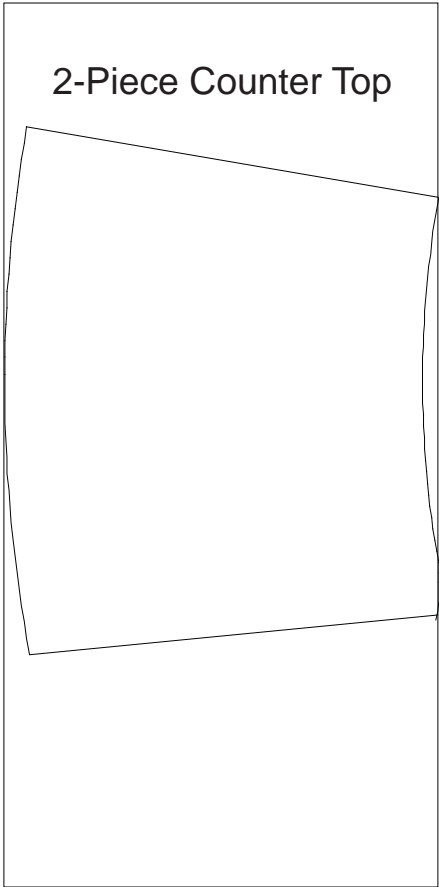

2-Piece Counter Top

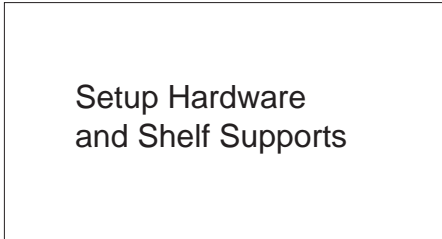

Setup Hardware  
and Shelf Supports

WHEN DISASSEMBLING ALUMINUM EXTRUSION, TIGHTEN ALL SETSCREWS AND LOCKS TO PREVENT LOSS DURING SHIPPING