

General Setup Instructions

Using Your Setup Instructions

The Setup Instructions are created specifically for your configuration. They are laid out sequentially in levels, including exploded views, and a logical series of detailed steps to assemble the main structure and components. We encourage you to study the instructions **before** attempting to assemble your exhibit.

Each page reminds you to tighten the setscrews after disassembling your exhibit to prevent loss of the locks and setscrews (see below in RED). This is VERY IMPORTANT.

Cleaning and Packing Your Display

- 1) Use care when cleaning aluminum extrusion or Eco Glass inserts. Use only non-abrasive cleaners.
- 2) When cleaning laminate inserts, countertops, or panels use mild cleansers and a soft material such as cotton.
- 3) Keep all display components away from extreme heat and long exposure to sunlight to avoid warping and fading.
- 4) Retain all packing material. It will make re-packing much easier and will reduce the likelihood of shipping damage. Each Layer will be labeled with the packing order.

General Setup Instructions for Panel System

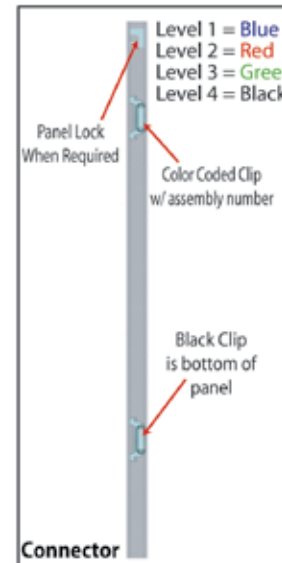

Each component has 2 clips, the lower clip is ALWAYS black. The top clip is color coded to distinguish the level. The color coded clip also contains the numbered label.

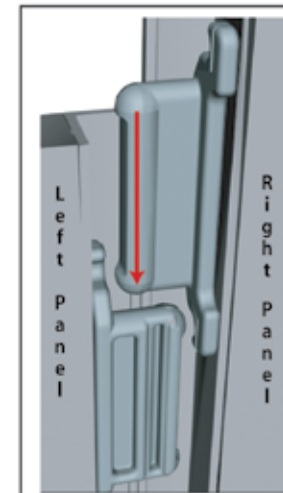

Cut Away View Of Slide Clips

Components connect together by aligning them and sliding downward connecting clips together.

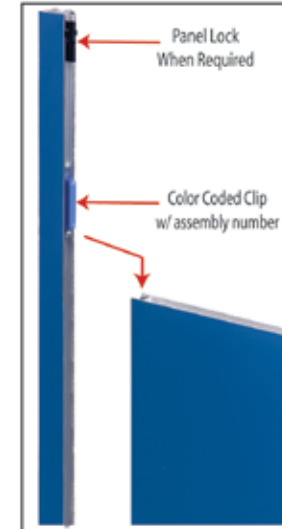

Example of Connection

Configurations are assembled from left to right, usually starting with #1 and following the numbered sequence.

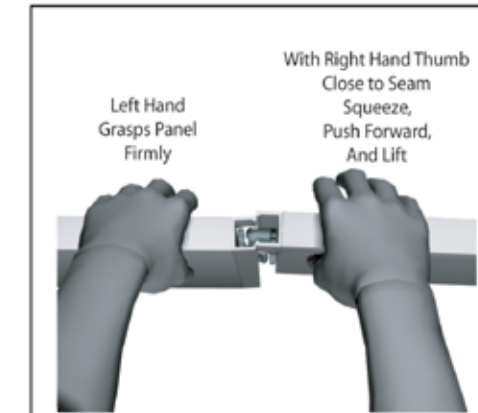

Top View of Panels with Locks

The first level of components contains panel locks that are located at the top of the panel for extra stability and a seamless connection. When disassembling panels, twist top connection slightly and lift right panel upward.

General Setup Instructions for Extrusion System



The Tool

Most exhibits can be assembled with the supplied Hex Key Tool. Occasionally, other tools may be needed.



Typical Connection

Most horizontal extrusion connections have a patented expandable lock. This lock inserts into the groove of an opposing extrusion. Tightening the lock with the Hex Key Tool expands the lock and creates a strong positive connection.



Typical Connection (cont'd)

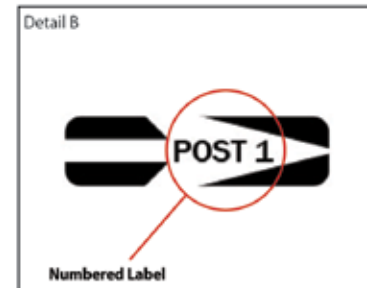

Numbered Label

Each extrusion contains a numbered label which corresponds with setup instructions. The label is located within a groove of the extrusion (when possible). With extrusion components the labels contain Black numbers unless otherwise specified.

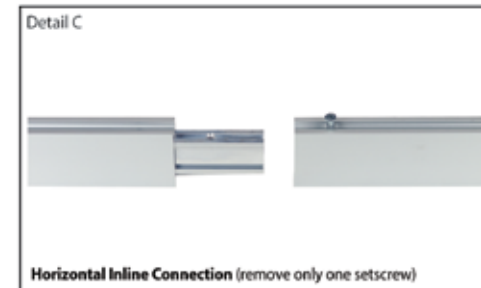

Horizontal Inline Connection (remove only one setscrew)

Remove only (1) setscrew when disassembling. Replace setscrew in extrusion after assembling it. Before packing, replace setscrew in extrusion to avoid losing it.

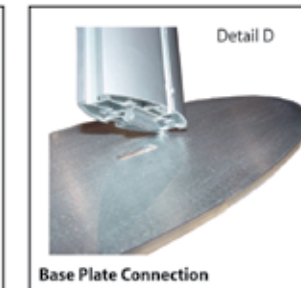

Base Plate Connection

Attach base plate to vertical extrusion using the lock provided. Place base plate on ground and set vertical post/lock in base plate slot. Tighten lock with Mult-tool.

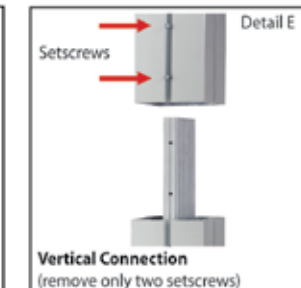

Vertical Connection (remove only two setscrews)

When vertical extrusions are packed in portable cases rather than crates or tubs, they must be broken down into smaller sections which then require assembly.

Remove only (2) setscrews when disassembling. Replace setscrews in extrusion after assembling it. Before packing, replace setscrews in extrusion to avoid losing them.

Part Number	Qty	Description
1	4	Base Plates
2	2	88" h Vertical extrusion
3	1	88" h Vertical extrusion w/ Door Hinges attached
4	1	88" h Vertical extrusion w/ Door Stop attached
7	2	7.5" Horizontal w/ Velcro attached to Back of member
8	1	Lower Curved Horizontal w/ Velcro attached to Back of member
9	1	Upper Curved Horizontal w/ Velcro attached to Back of member
10	1	36" Horizontal extrusion

Steps

- 1) Attach vertical extrusions [2, 3 and 4] to the oval base plates [1], see detail D on general information page.
- 2) Connect horizontal extrusions [7 and 8] between vertical extrusions [2 and 3] placing laminated panels under curved horizontal bar [8] as shown.
- 3) Connect horizontal extrusions [7 and 9] between vertical extrusions [2 and 3].
- 4) Connect horizontal extrusion [10] between vertical extrusions [3 and 4] and flush to top.
- 5) Attach large door to hinges on vertical extrusion [3] as shown in detail.
- 6) Attach graphics.

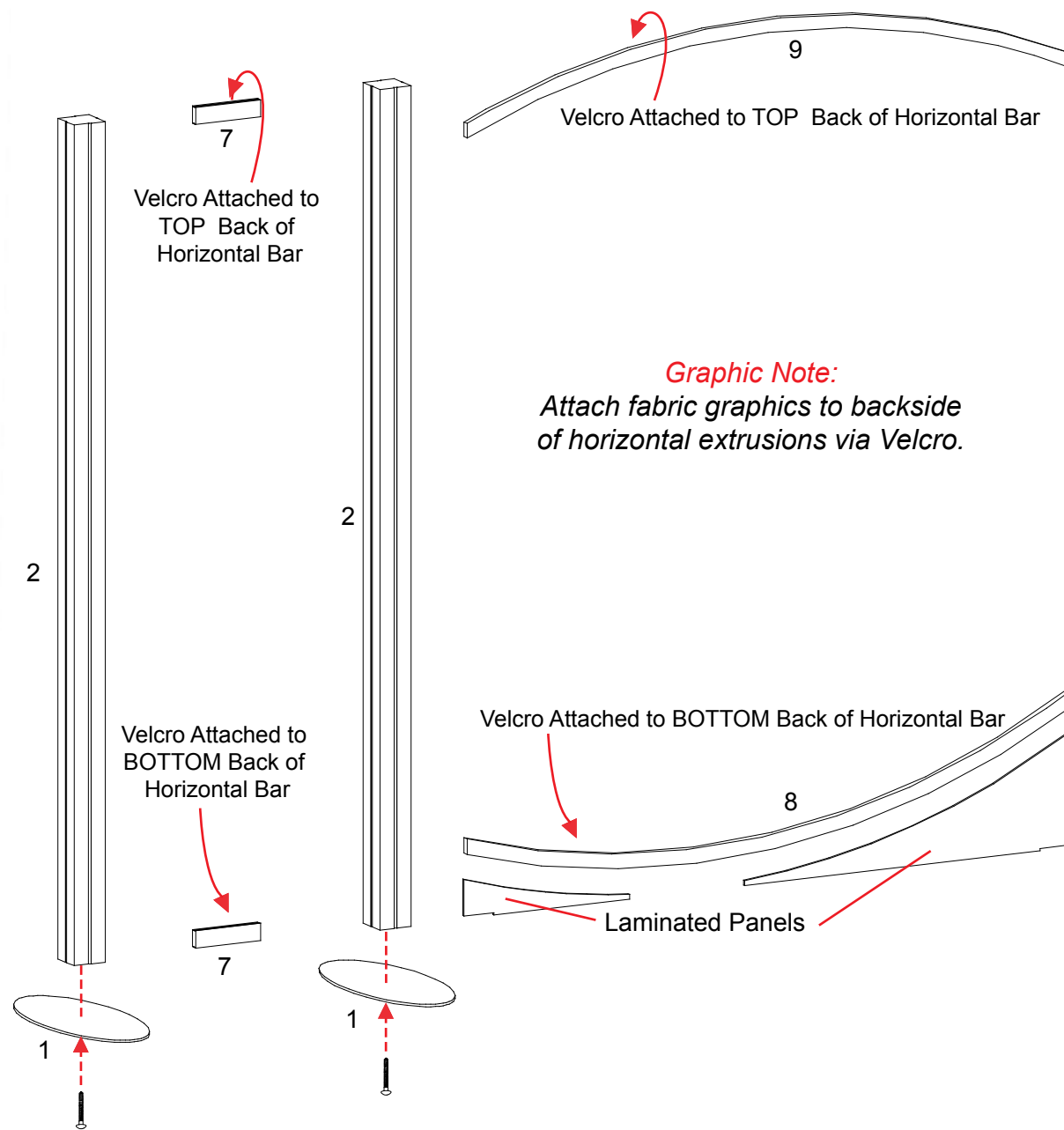

Graphic Note:
Attach fabric graphics to backside of horizontal extrusions via Velcro.

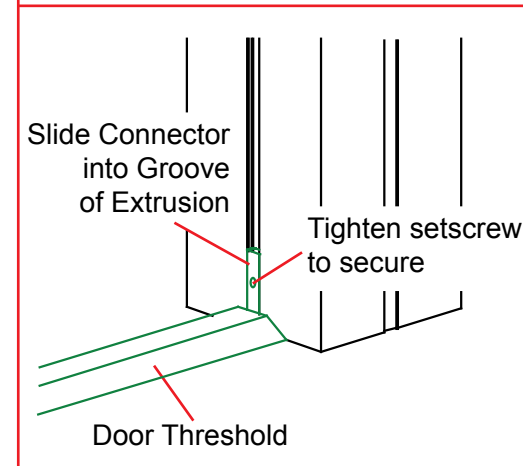
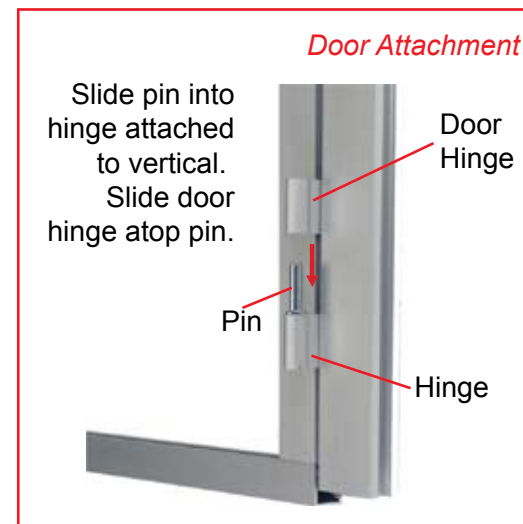

SEG Graphic Installation

Graphic: To Ensure Proper Fit

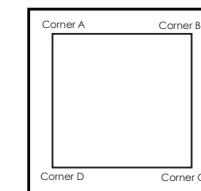

It is important to first insert graphic into each alternate corner then to the sides of the frame. If this is not done, graphic will not fit into the frame correctly.



Step 1
Insert corner A. Turn edge of graphic so silicon well is perpendicular to face of graphic. Insert narrow side of well with fabric to outside into the channel. Repeat for other side of this corner.



Step 2
Repeat Step 1 for opposite corner C, then insert corner B, followed by corner D, to complete the installation of the corners.



Step 3
Once all corners are inserted, press one silicon edge into channel from corners and work toward the center. Make sure well is fully inserted into channel. Continue until all sides are done. Smooth out edges of graphic.



Graphic Removal
To remove the graphic from the frame, locate the fabric pull tab. Gently pull up on the tab to remove the fabric.

Part Number	Qty	Description
1	3	Base Plates
5	3	88" h Vertical extrusion
6	2	88" h Vertical extrusion
7	4	7.5" Horizontal w/ Velcro attached to Back of member
11	4	18.5" Horizontal w/ Velcro attached to Front of member
13	2	58" Horizontal w/ Velcro attached to Front of member

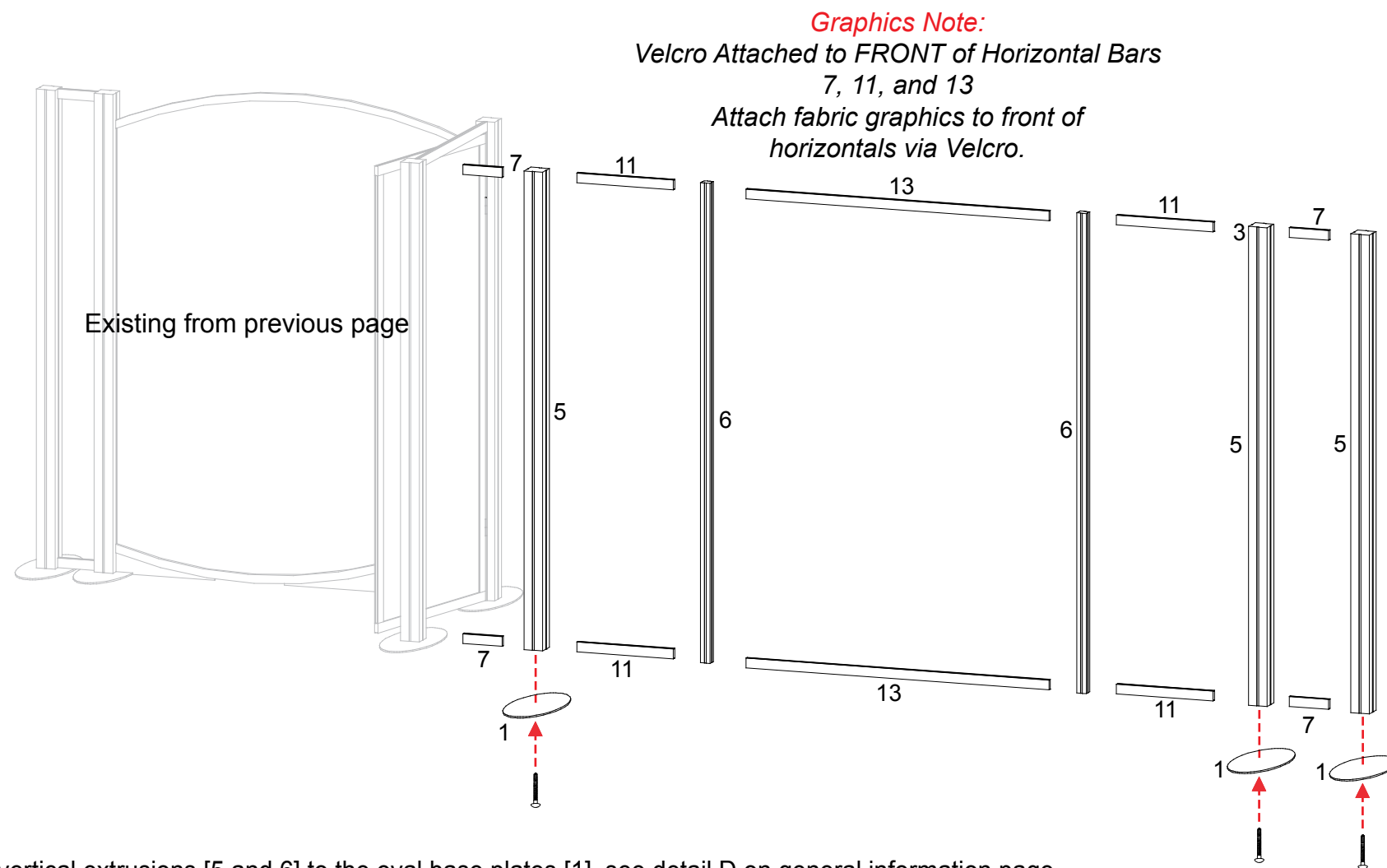
**Steps**

- 1) Attach vertical extrusions [5 and 6] to the oval base plates [1], see detail D on general information page.
- 2) Connect lower horizontal extrusions [7 thru 13] between vertical extrusions [5 and 6] as shown.
- 3) Connect upper horizontal extrusions [7 thru 13] between vertical extrusions [2, 5 and 6].
- 4) Attach Graphics.

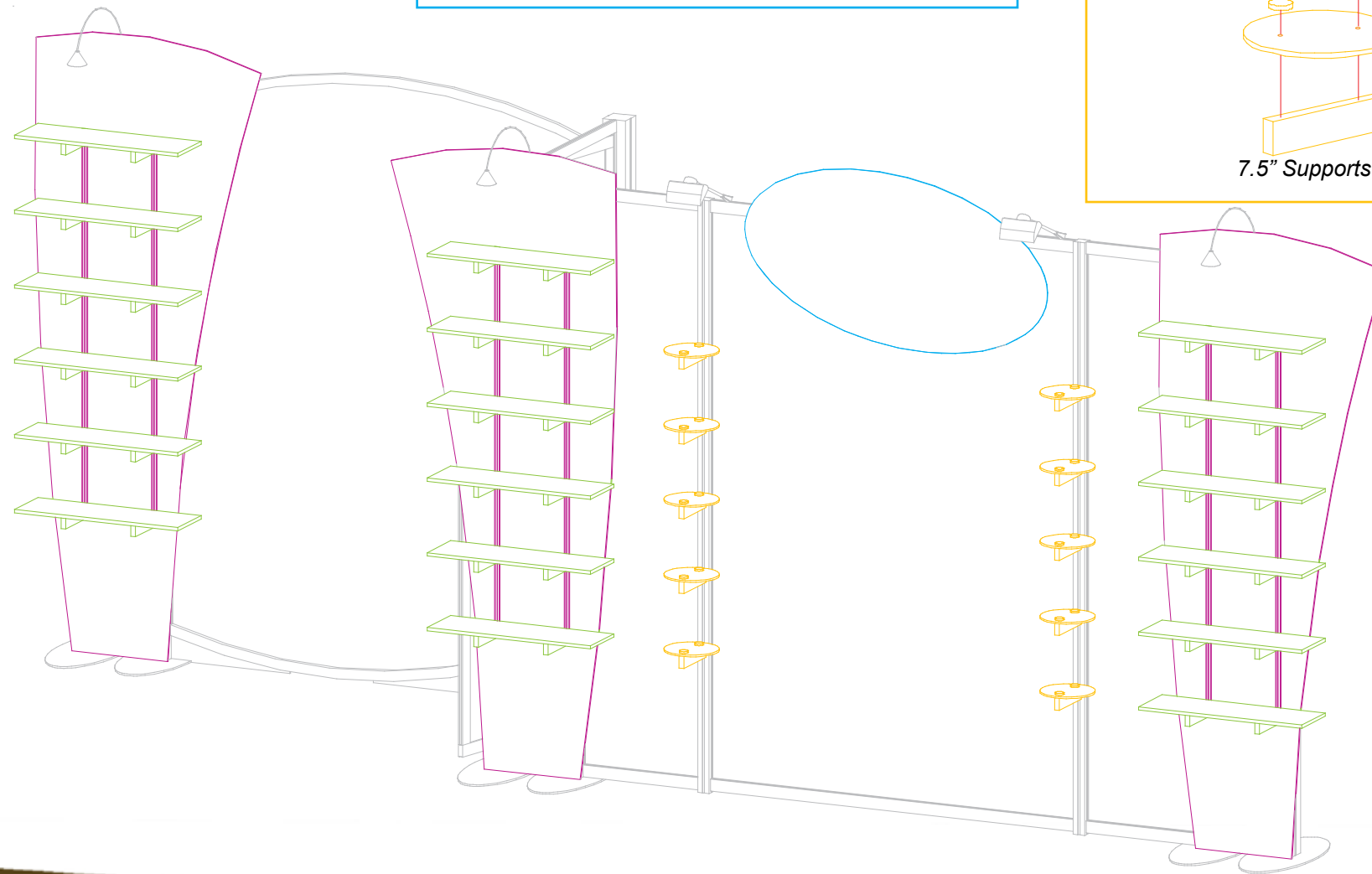
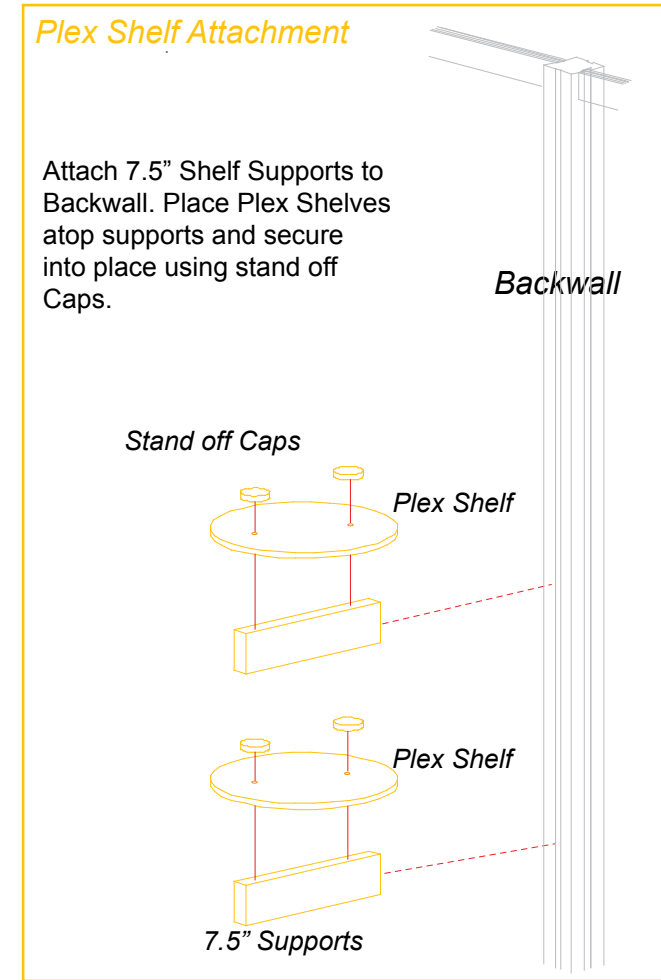
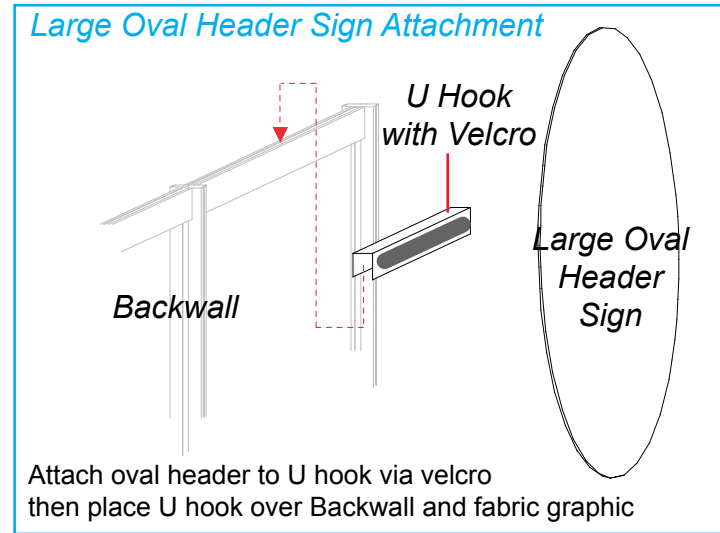
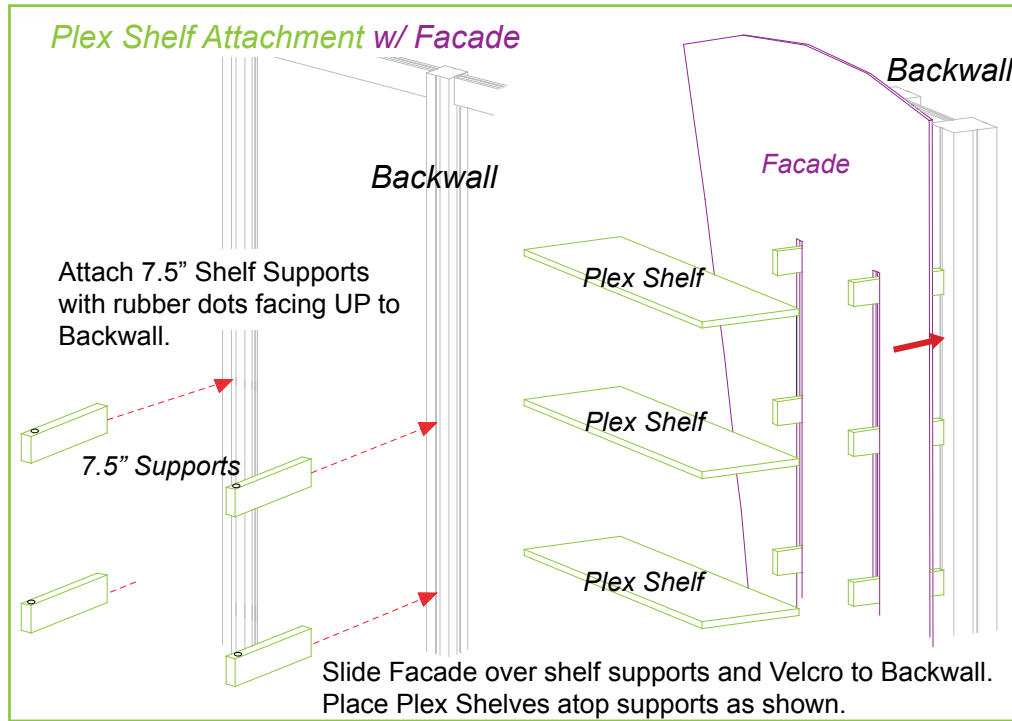

* Arch LED Light Detail



- Attach lights where shown by clamping on to top extrusion bar.

* LED Luminator Light Attachment Detail



- Attach Clip to Light Before mounting to Top Beam
- There will be a small slit in the Top of the Graphic to Slide the Clip through to the channel

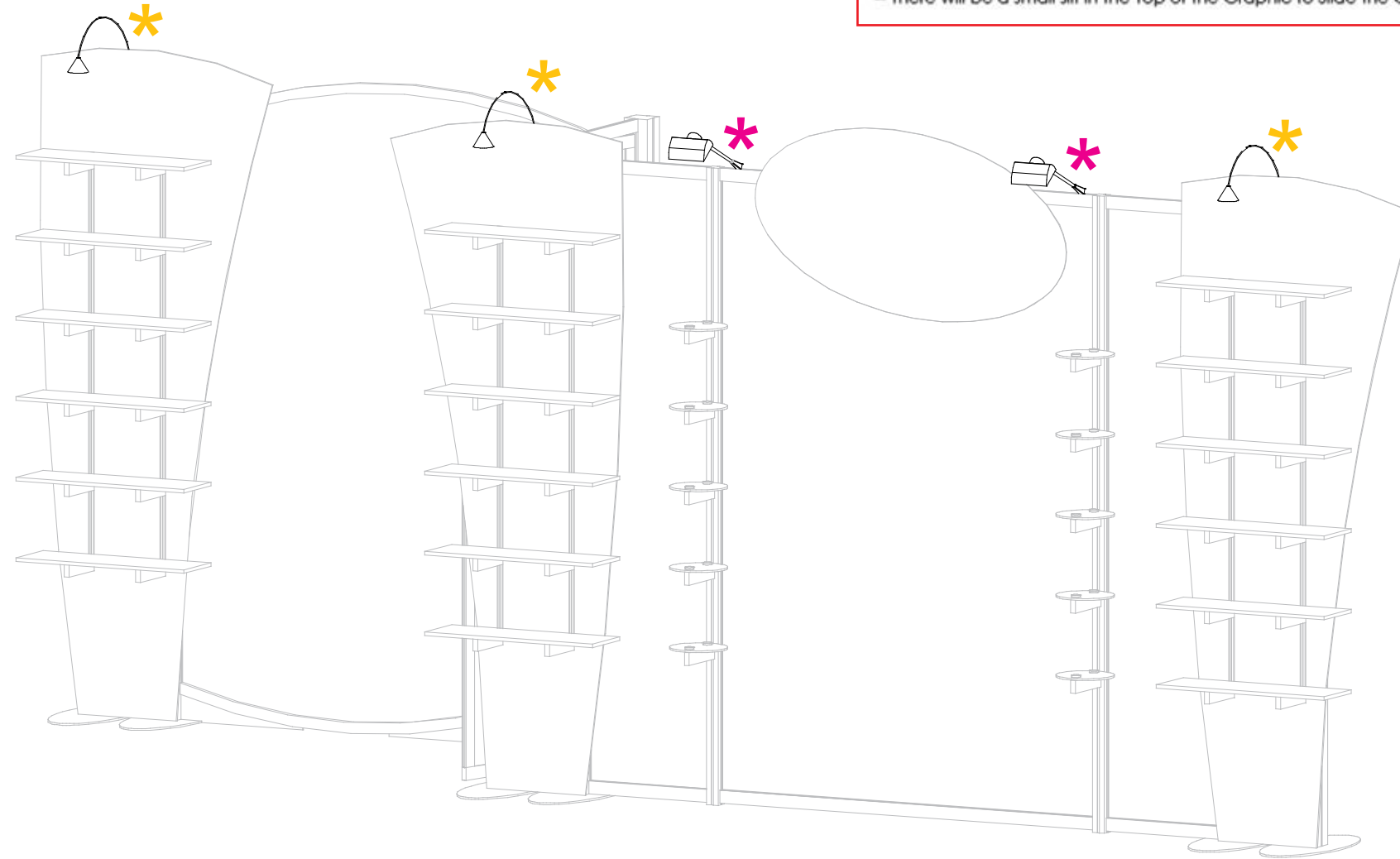

Part Number	Qty	Description
20	4	40"h Vertical extrusion
21	1	40"h Vertical extrusion w/ Door Stop
22	1	40"h Vertical extrusion w/ Door Hinges
23	2	21.9451" Curved Horizontal extrusion
24	4	8" Horizontal extrusion
25	2	15.4253" Curved Horizontal extrusion
26	4	9.9045" Curved Horizontal extrusion

Steps

- 1) Connect lower horizontal extrusions [23 thru 26] between vertical extrusions [20 thru 22] as shown.
- 2) Place inserts and door into vertical extrusions.
- 3) Connect upper horizontal extrusions [23 thru 26] between vertical extrusions [20 thru 22] and atop inserts and door.
- 4) Place shelf atop pins located on vertical extrusions.
- 5) Place counter atop assembled pedestal.
- 6) Attach graphic by referring to detail at right.

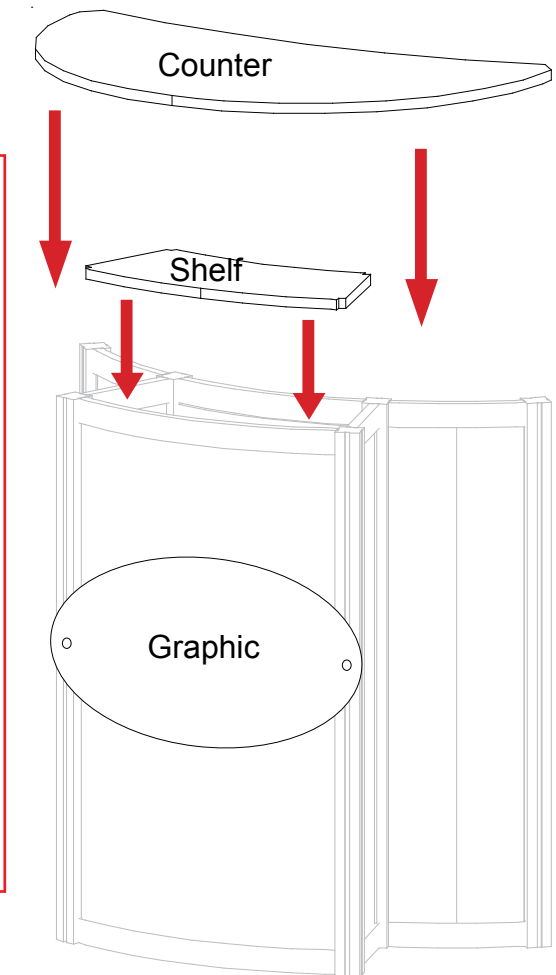
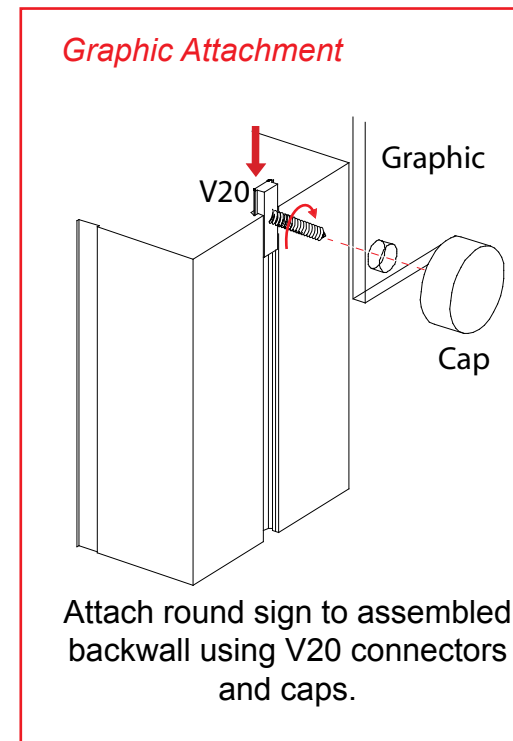
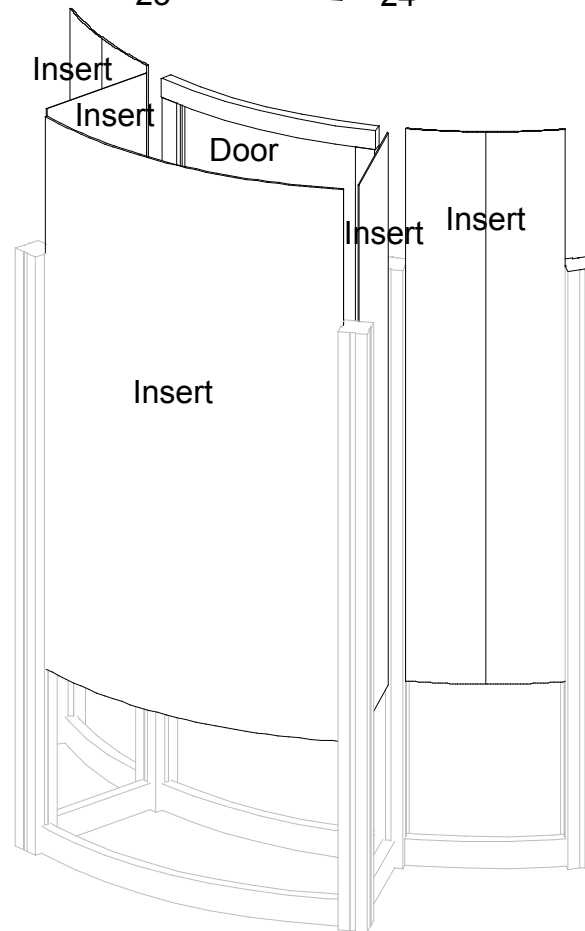
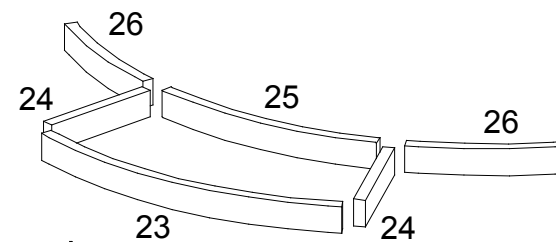
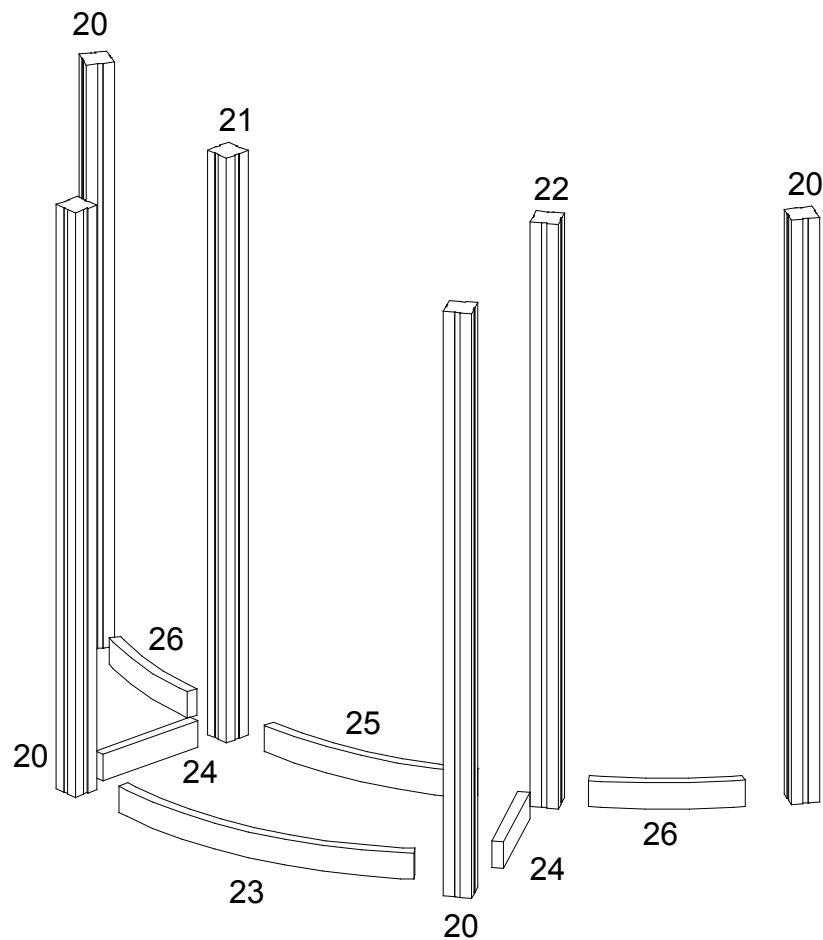
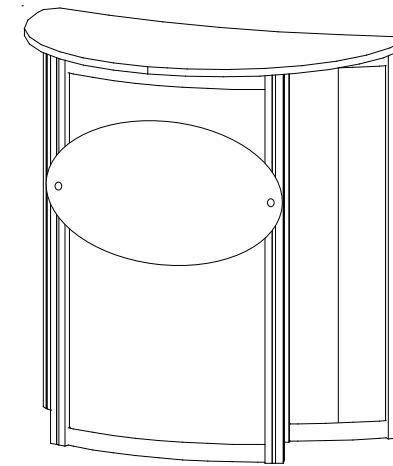

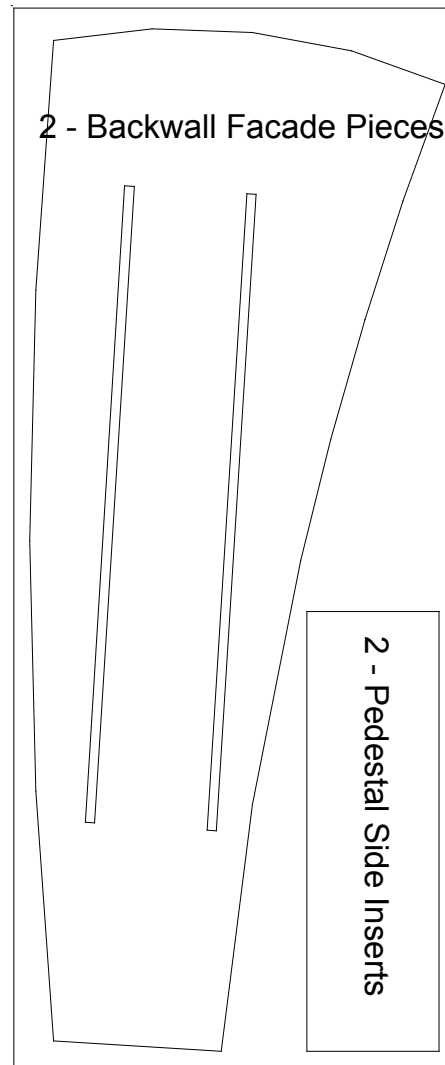

Level 1

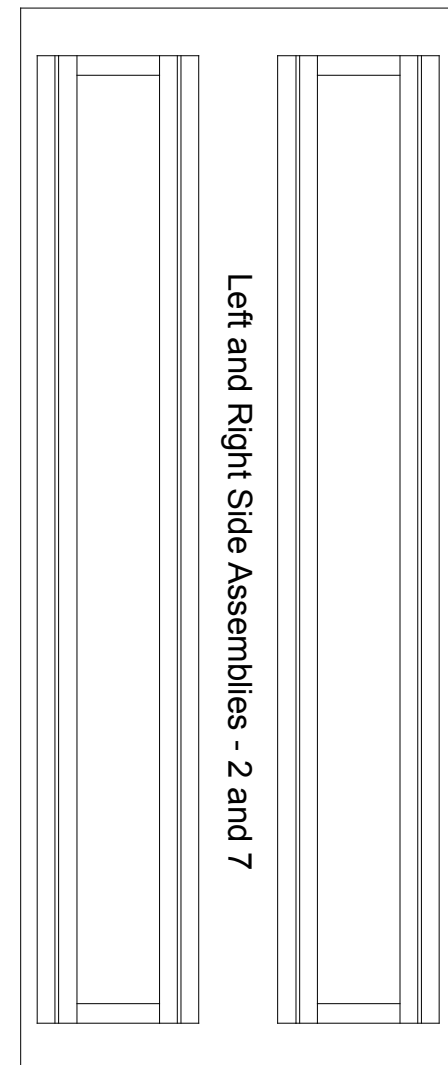

Level 2

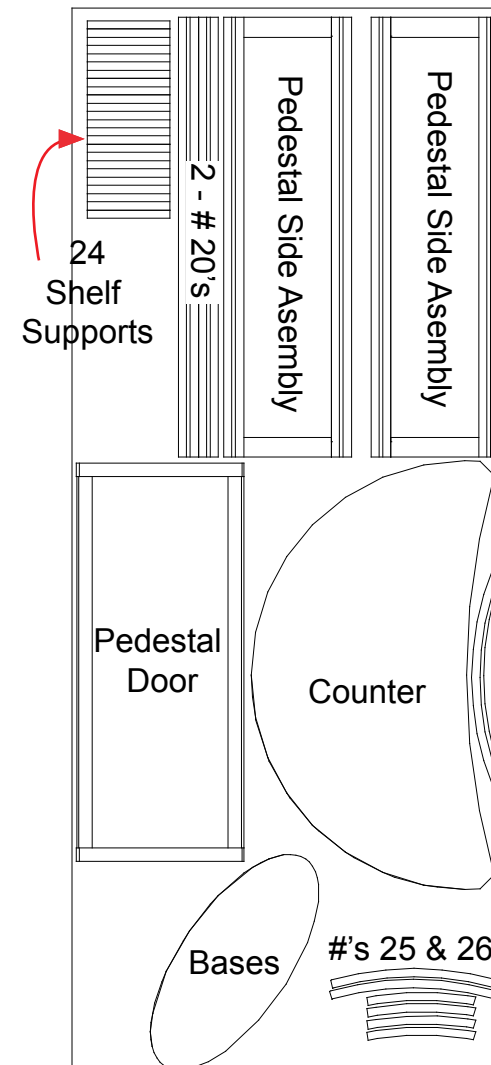

Level 3

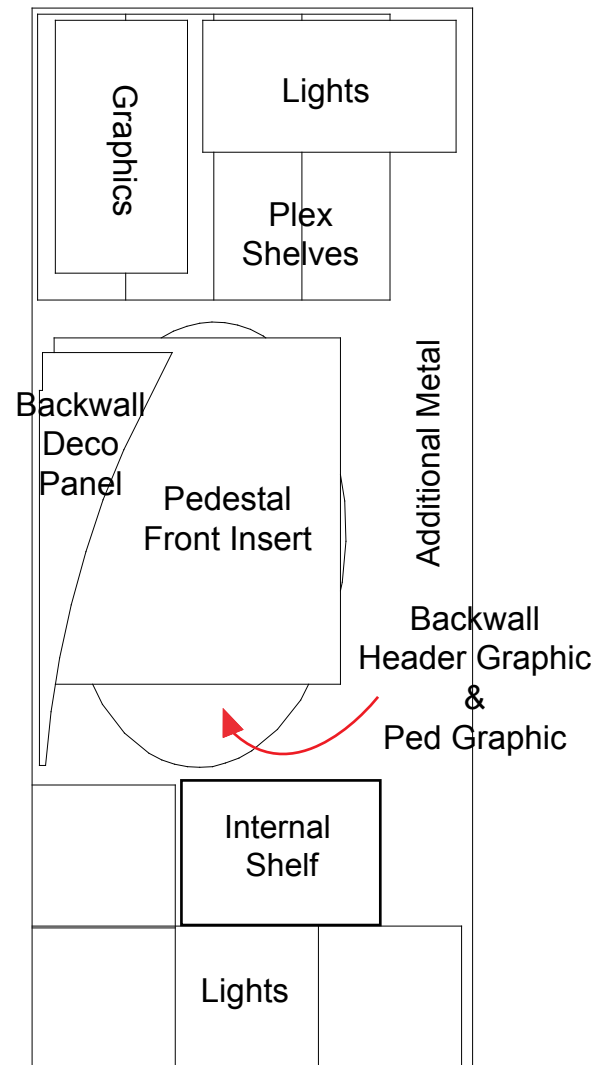

Level 4

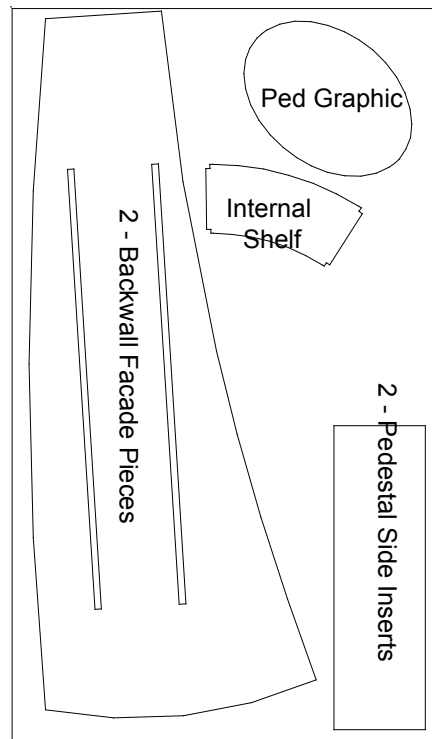
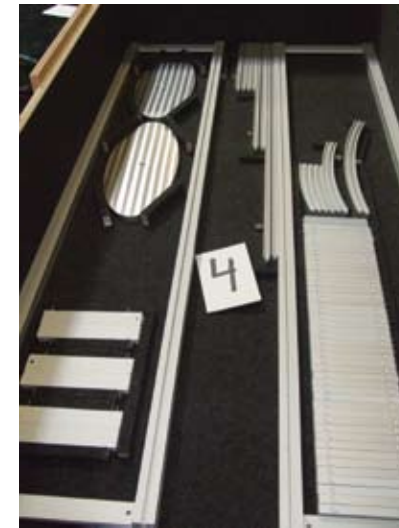

Level 1

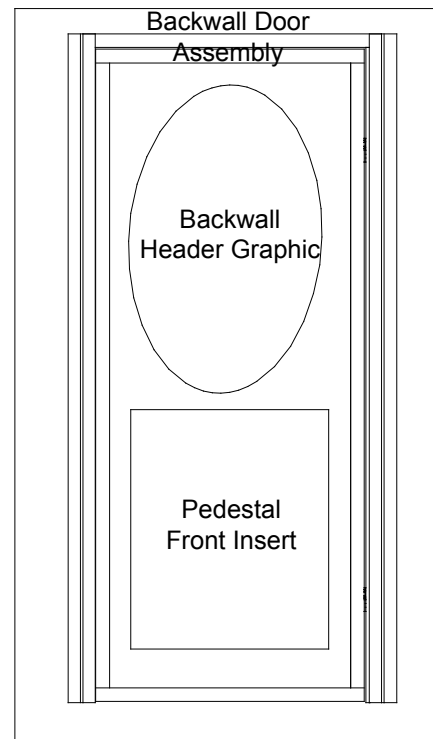

Level 2

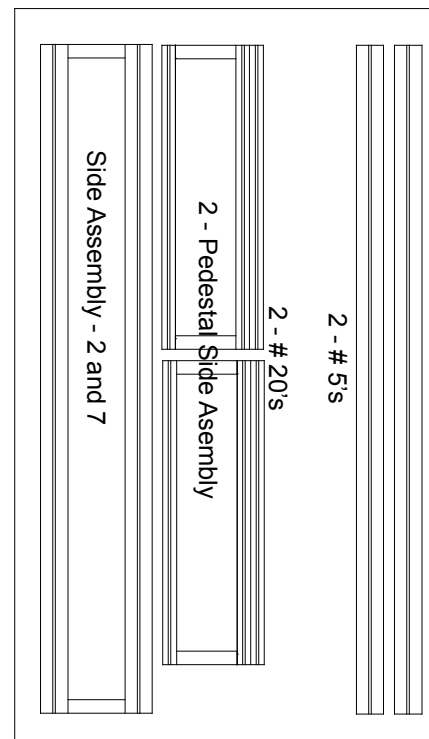

Level 3

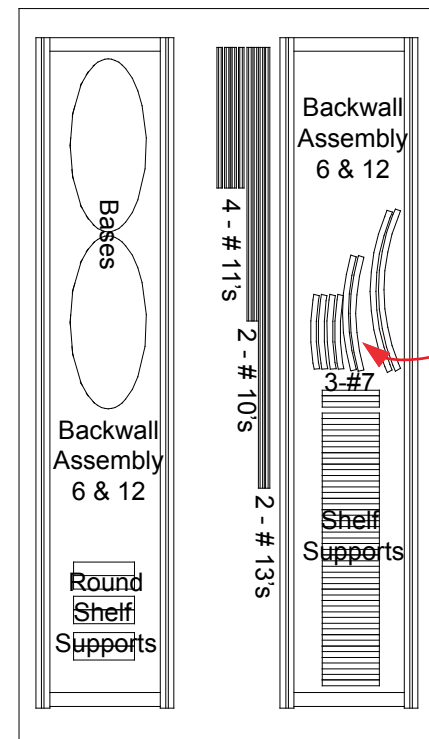

Level 4

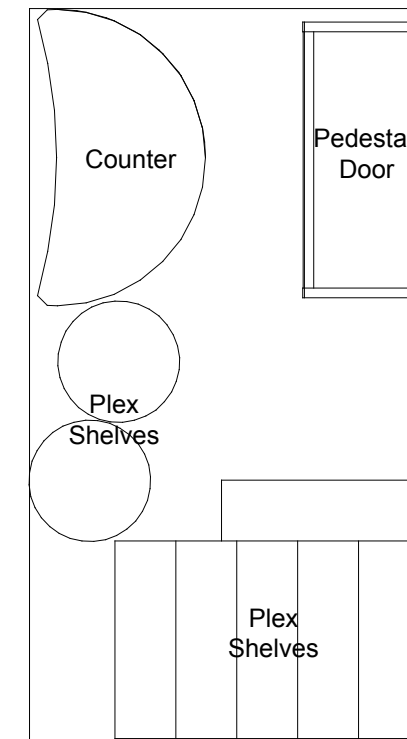

Level 5

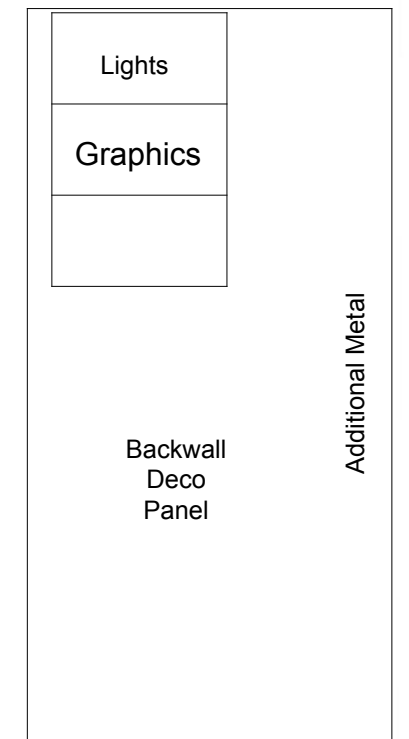

Level 6