

# visionary™

MAGELLAN DESIGNS

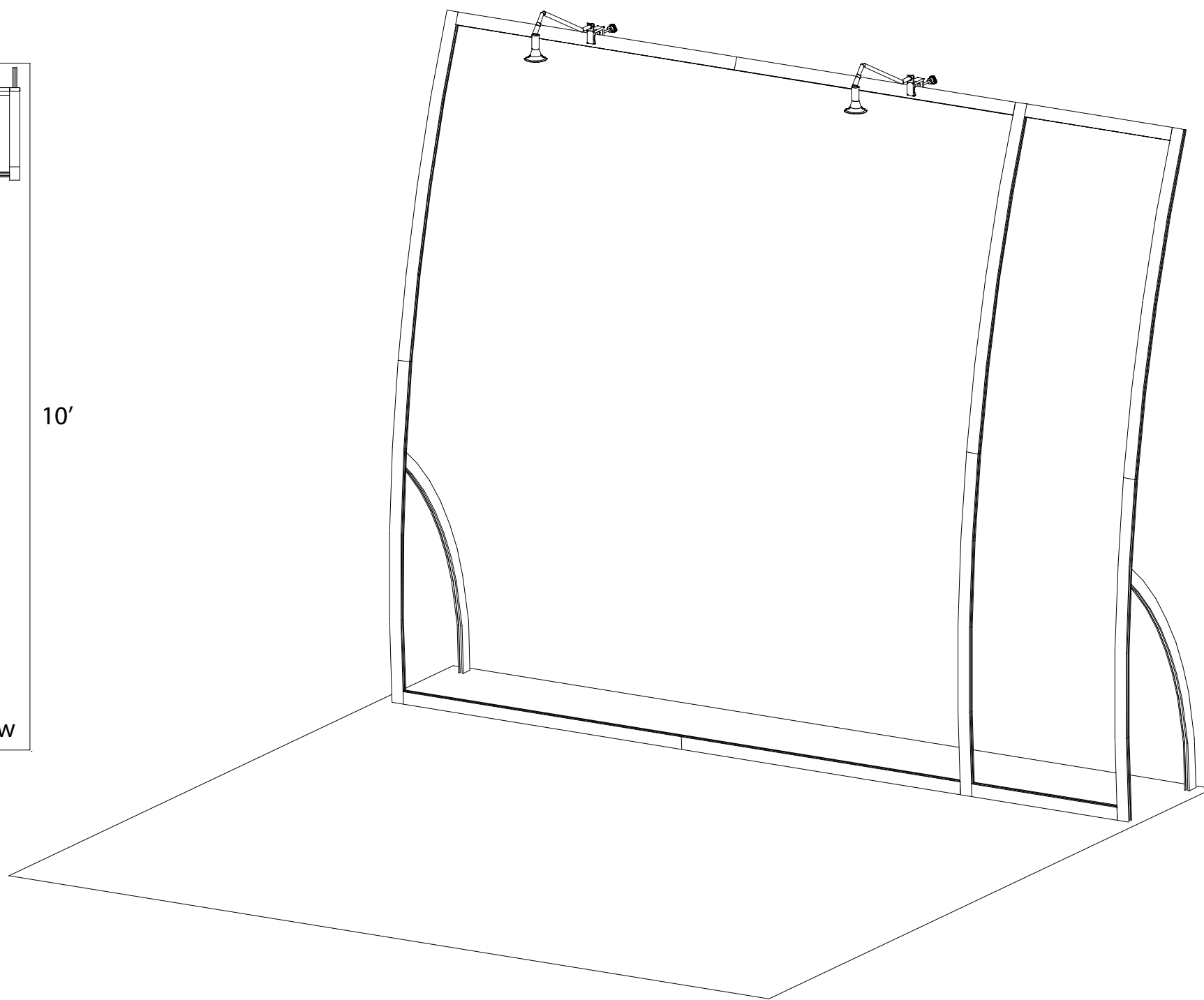
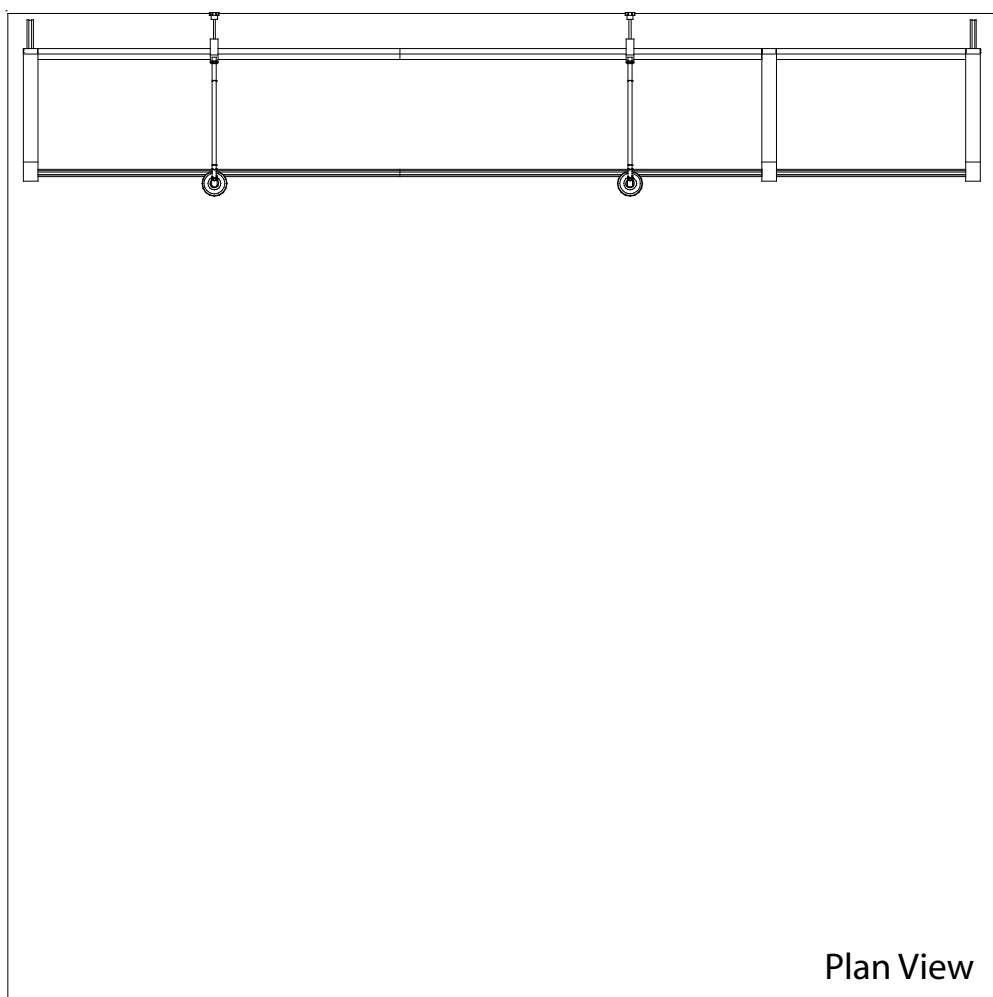

WHEN DISASSEMBLING ALUMINUM EXTRUSION, TIGHTEN ALL SETSCREWS AND LOCKS TO PREVENT LOSS DURING SHIPPING

# visionary™ IDESIGNS

## Using Your Setup Instructions

The Visionary Designs Setup Instructions are created specifically for your configuration. They are laid out sequentially, including an exploded view of the entire display, and then a logical series of detailed steps to assemble the main structure and components. We encourage you to study the instructions **before** attempting to assemble your exhibit.

Each page reminds you to tighten the setscrews after disassembling your exhibit to prevent loss of the locks and setscrews (see below in RED). This is **VERY IMPORTANT**.

## Cleaning and Packing Your Display

- 1) Use care when cleaning aluminum extrusion or acrylic inserts. Use only non-abrasive cleaners.
- 2) When cleaning laminate inserts or countertops, use mild cleansers and a soft material such as cotton.
- 3) Keep all display components away from extreme heat and long exposure to sunlight to avoid warping and fading.
- 4) Retain all packing material. It will make re-packing much easier and will reduce the likelihood of shipping damage.



**The Tool**

Most Visionary Designs exhibits can be assembled with the supplied Hex Key Tool. Occasionally, a flat head screwdriver may be required.



Detail A

**Typical Connection**



**Typical Connection (cont'd)**

Most horizontal extrusion connections have a patented expandable lock. This lock inserts into the groove of an opposing extrusion. Tightening the lock with the Hex Key Tool expands the lock and creates a strong positive connection.

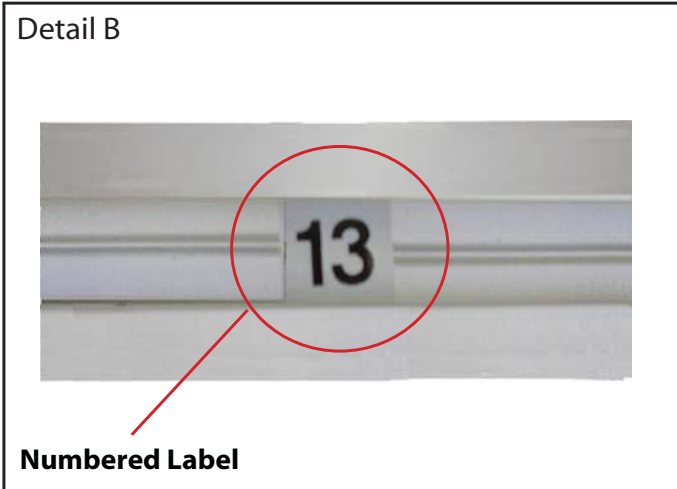

Detail B

**Numbered Label**

Each extrusion contains a numbered label which corresponds with setup instructions. The label is located within a groove of the extrusion (when possible). With Visionary Designs the labels contain Black numbers unless otherwise specified.



Detail C

**Horizontal Inline Connection** (remove only one setscrew)

Remove only (1) setscrew when disassembling. Replace setscrew in extrusion after assembling it. Before packing, replace setscrew in extrusion to avoid losing it.

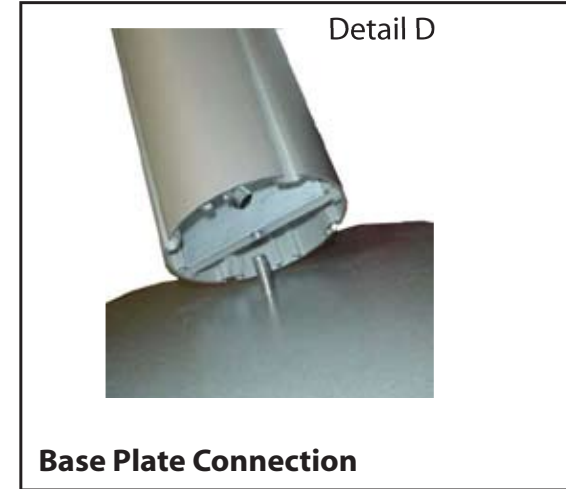

Detail D

**Base Plate Connection**

Attach base plate to round or square vertical extrusion using the bolt provided. Be careful not to strip the threads.

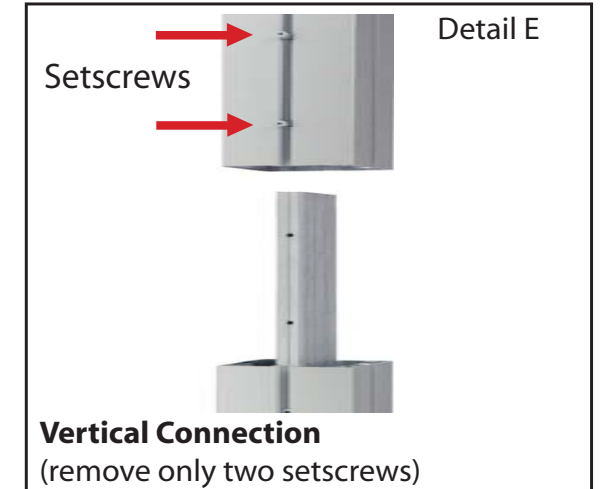

Detail E

**Vertical Connection**  
(remove only two setscrews)

When vertical extrusions are packed in portable cases rather than crates or tubs, they must be broken down into smaller sections which then require assembly.

Remove only (2) setscrews when disassembling. Replace setscrews in extrusion after assembling it. Before packing, replace setscrews in extrusion to avoid losing them.

**WHEN DISASSEMBLING ALUMINUM EXTRUSION, TIGHTEN ALL SETSCREWS AND LOCKS TO PREVENT LOSS DURING SHIPPING**

Part Number	Qty	Description
1	1	48.5"h Lower Curved Extrusion
2	1	48.5"h Upper Curved Extrusion
3	1	48.5"h Lower Curved Extrusion
4	1	48.5"h Upper Curved Extrusion
5	1	48.5"h Lower Curved Extrusion
6	1	48.5"h Upper Curved Extrusion
7a/7b	1/1	44"w Horizontal Extrusion
8a/8b	1/1	44"w Horizontal Extrusion
9	1	23"w Horizontal Extrusion
10	1	23"w Horizontal Extrusion
11	1	Backwall Support Leg Extrusion
12	1	Backwall Support Leg Extrusion

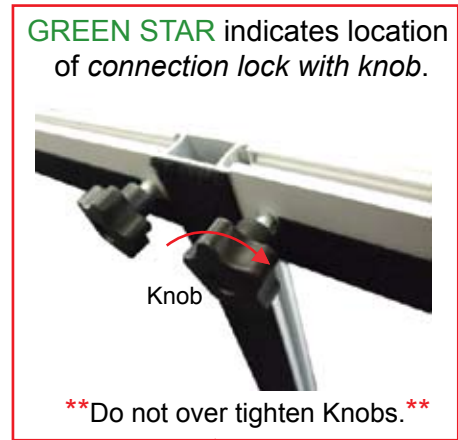
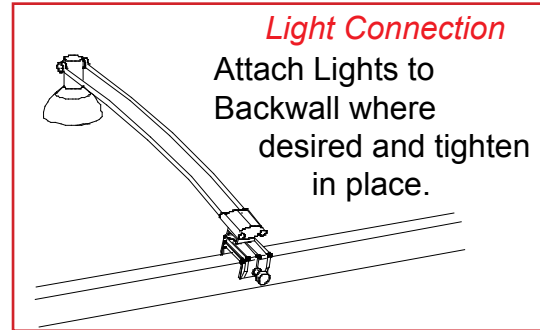

Steps

*Unit can be assembled face down on the floor then lifted upright.*

- 1) Connect backwall upper and lower verticals together [ 1 to 2, 3 to 4 and 5 to 6].
- 2) Connect horizontal extrusions together [7a to 7b and 8a to 8b].
- 3) Attach horizontal assemblies [7a/7b and 8a/8b] between vertical assemblies [1/2 and 3/4].
- 4) Attach horizontal extrusions [9 and 10] between vertical assemblies [3/4 and 5/6].
- 5) Attach support leg extrusions [11 and 12] to back of verticals [1 and 5], see leg attachment detail.

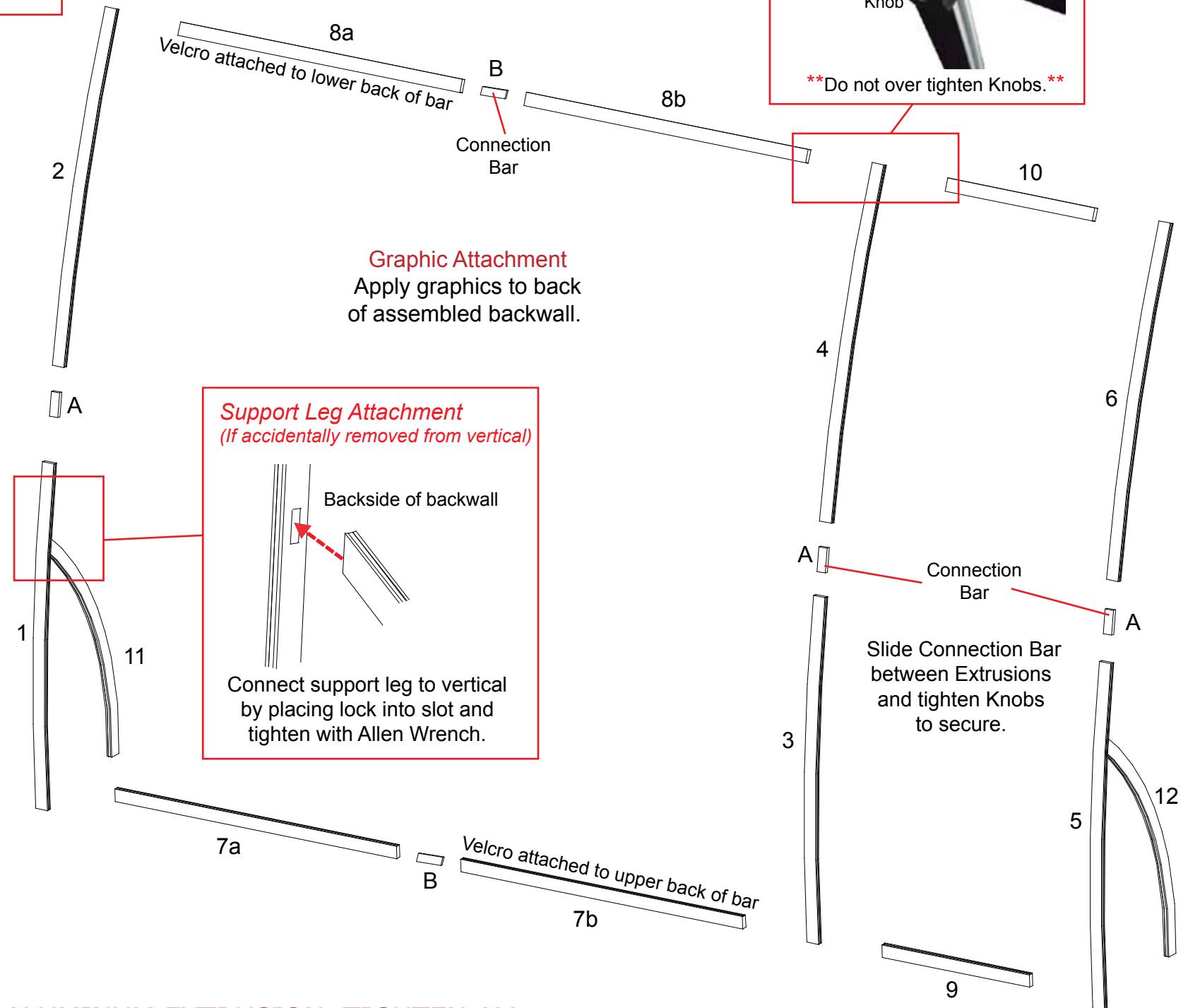
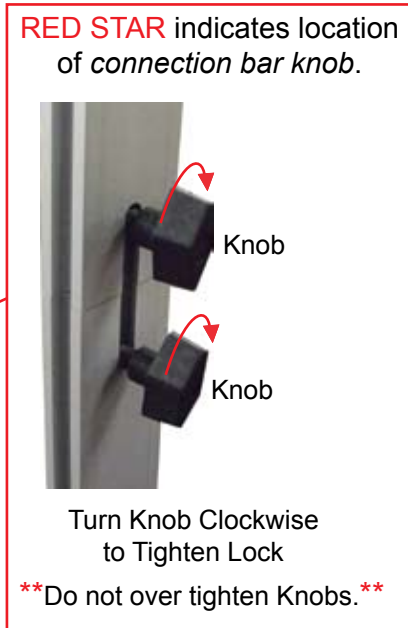
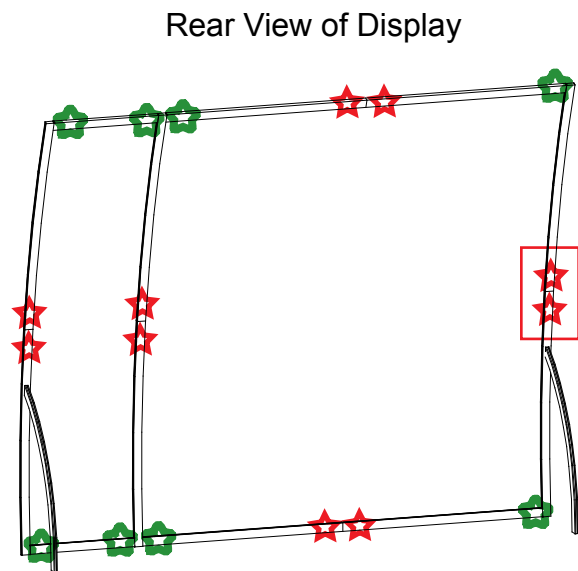

**WHEN DISASSEMBLING ALUMINUM EXTRUSION, TIGHTEN ALL SETSCREWS AND LOCKS TO PREVENT LOSS DURING SHIPPING**

Case 1: Backwall Components

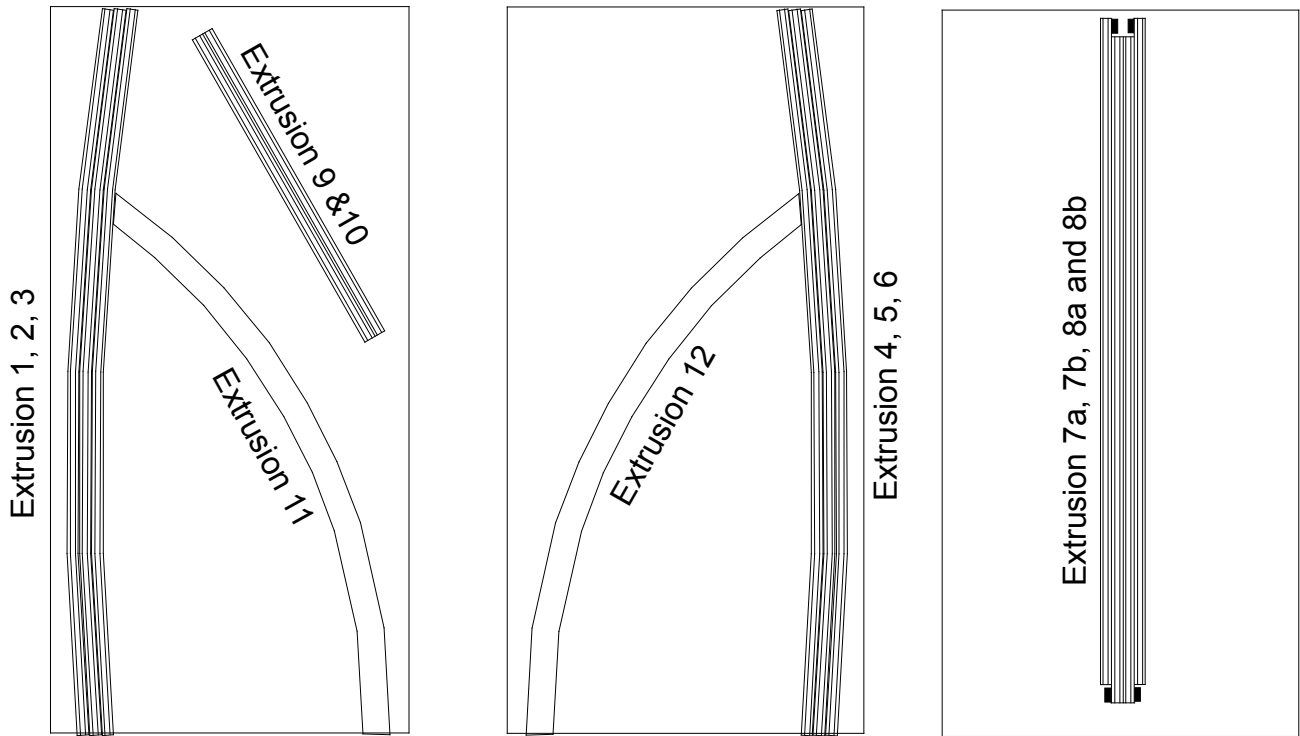

*Additional Items:*  
Halogen Lights  
Graphics  
Setup Hardware

WHEN DISASSEMBLING ALUMINUM EXTRUSION, TIGHTEN ALL SETSCREWS AND LOCKS TO PREVENT LOSS DURING SHIPPING