

# Perfect 10 Hybrid Displays

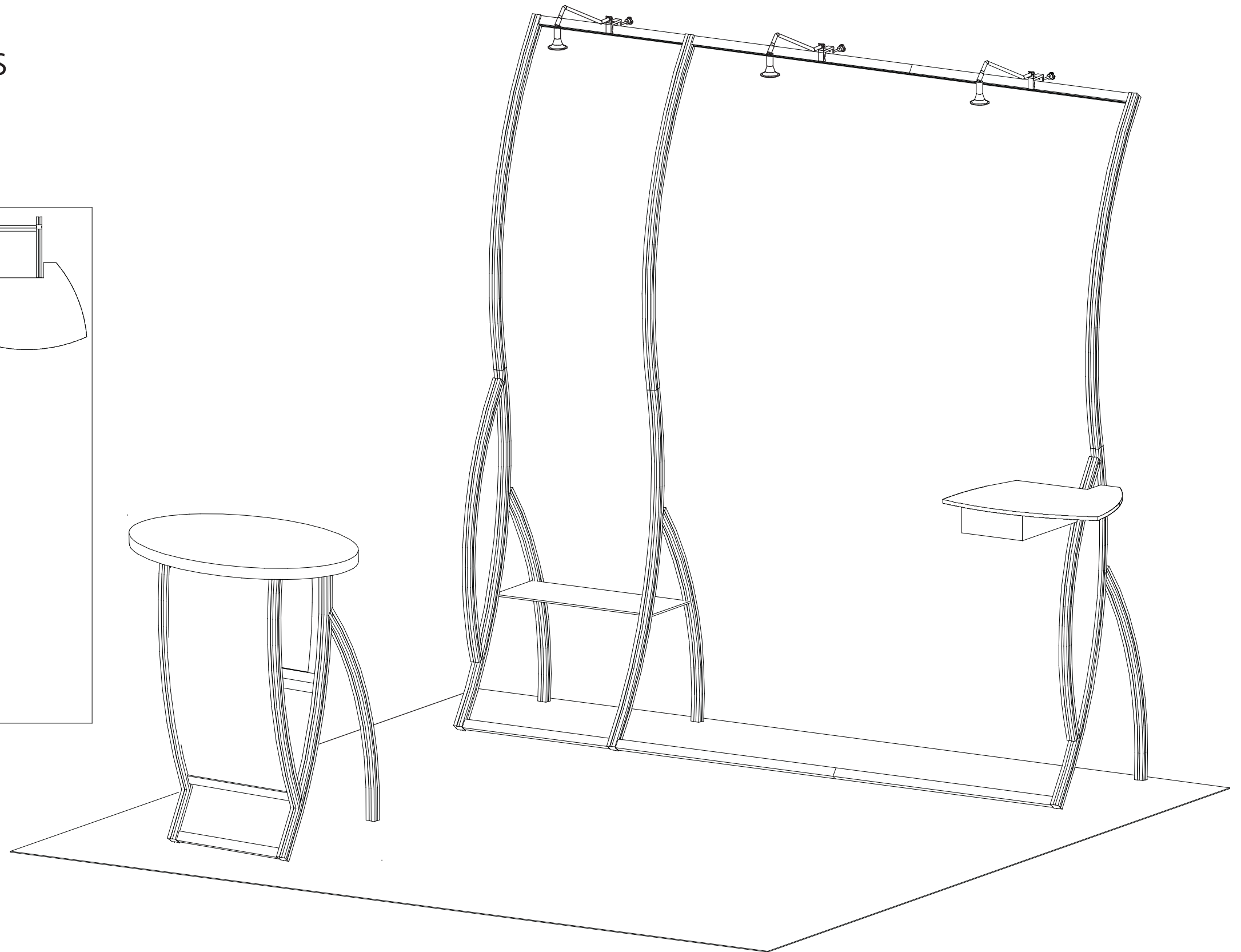
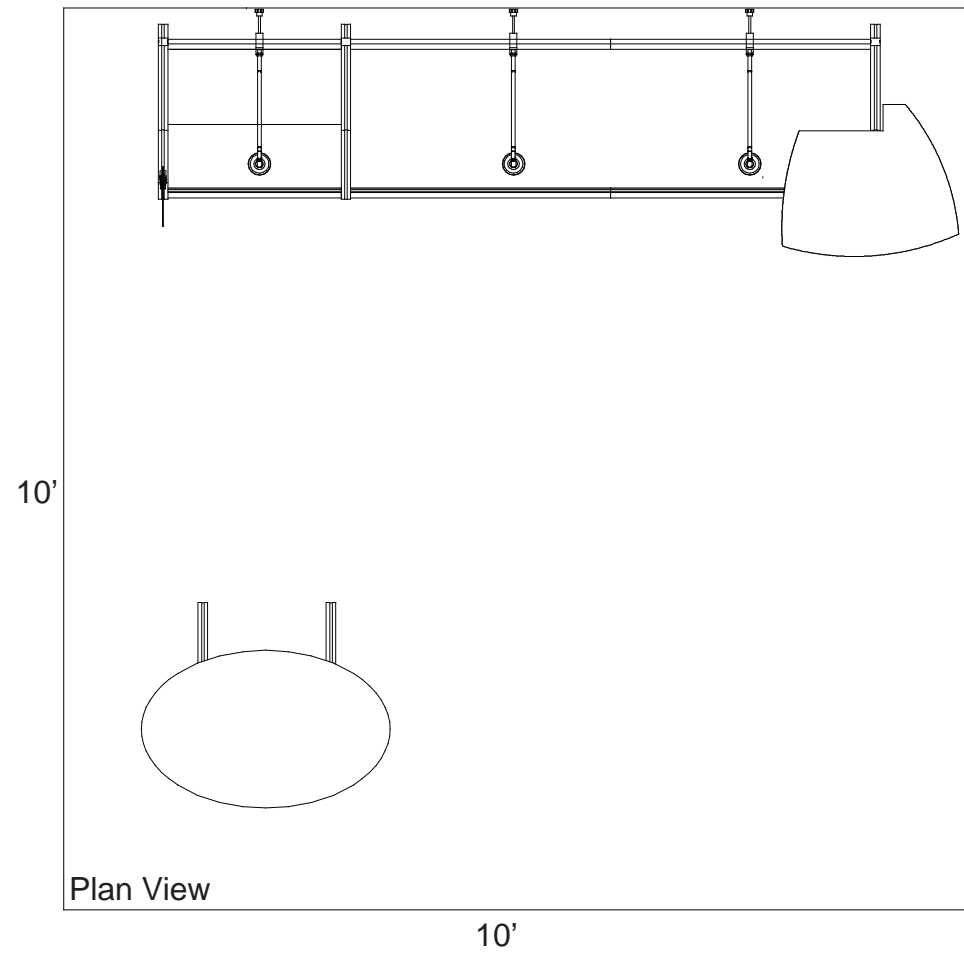

WHEN DISASSEMBLING TIGHTEN ALL KNOBS TO PREVENT LOSS DURING SHIPPING

Part Number	Description
1	Left Leg Assembly
2	Middle Leg Assembly
3A	Upper Curved Vertical
3	Upper Curved Vertical
4	23"w Horizontal

Step 1:

NOTE: Can be assembled either face down on floor then lifted upright or upright as shown in drawings.

- A) Connect vertical leg assemblies [1 and 2] together by connecting horizontal extrusions [4] between assemblies tightening BLACK knobs on backside of extrusion making sure Velcro faces toward BACK and placing it about one inch up from bottom and tightening.
- B) Connect vertical extrusions [3 and 3A] to leg assemblies [1 and 2] using vertical connection bar as shown.
- C) Connect upper horizontal extrusion [4] between verticals [3 and 3A] placing it about one inch down from top.

NOTE: Make sure the lock is flush with extrusion before tightening. If lock will not fully engage, gently rock lock and extrusion while turning knob until lock fully opens.



Rear View of Display

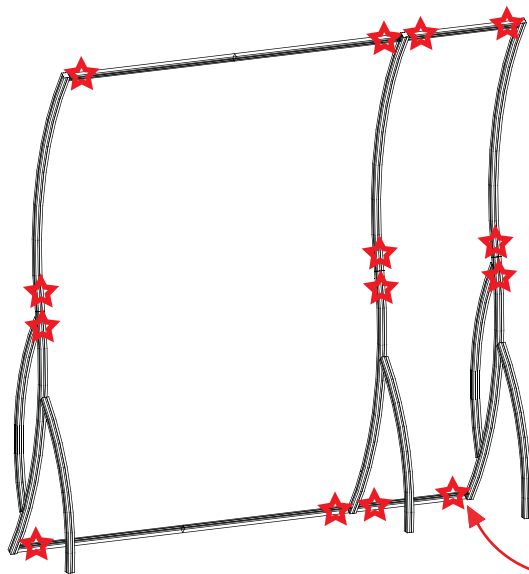

STAR indicates location of knobs on BACKSIDE of unit.

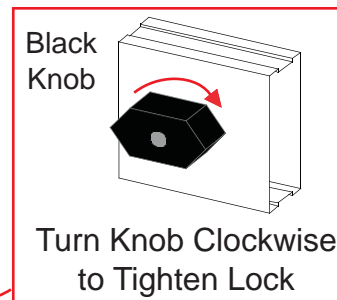

Step 1

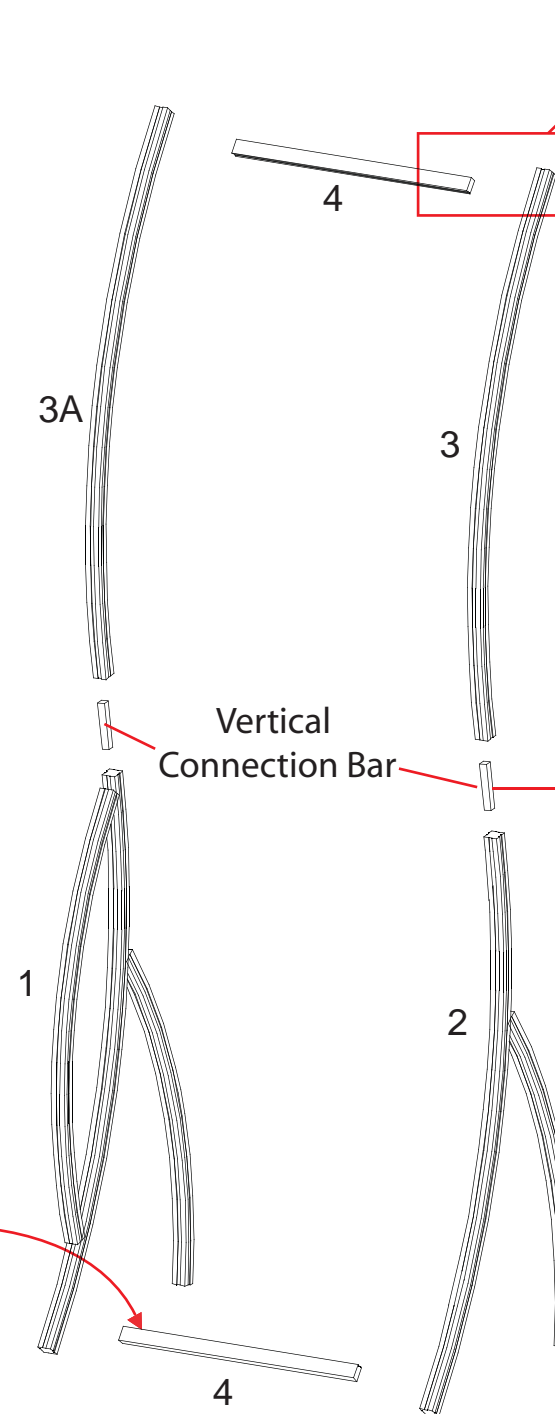

NOTE: When assembling horizontals they should be placed approximately one inch from TOP and BOTTOM.

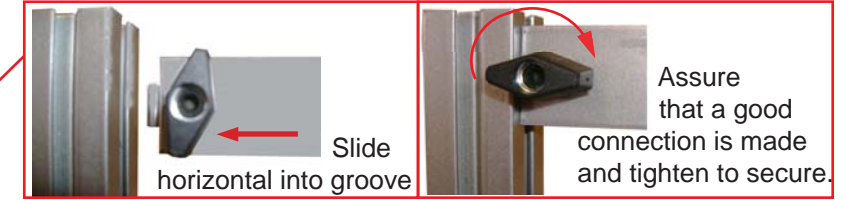

Slide Connection Bar into lower leg assembly. Slide upper vertical over bar and secure both.

Step stool may be required for assembly.



WHEN DISASSEMBLING TIGHTEN ALL KNOBS TO PREVENT LOSS DURING SHIPPING

Part Number	Description
5	Right Leg Assembly
6	Upper Curved Vertical
7	69" w Horizontal w/ Hinge Facing UP
8	69" w Horizontal w/ Hinge Facing DOWN

Step 2

Step 2:

NOTE: Can be assembled either face down on floor then lifted upright or upright as shown in drawings.

- A) Connect vertical extrusion [6] to leg assembly [5] using vertical connection bar as shown.
- B) Connect horizontal extrusions [7 and 8] between vertical assemblies by tightening BLACK knobs on backside of extrusion making sure Velcro faces toward BACK.

NOTE: Make sure the lock is flush with extrusion before tightening. If lock will not fully engage, gently rock lock and extrusion while turning knob until lock fully opens.



NOTE: When assembling horizontals they should be placed approximately one inch from TOP and BOTTOM.

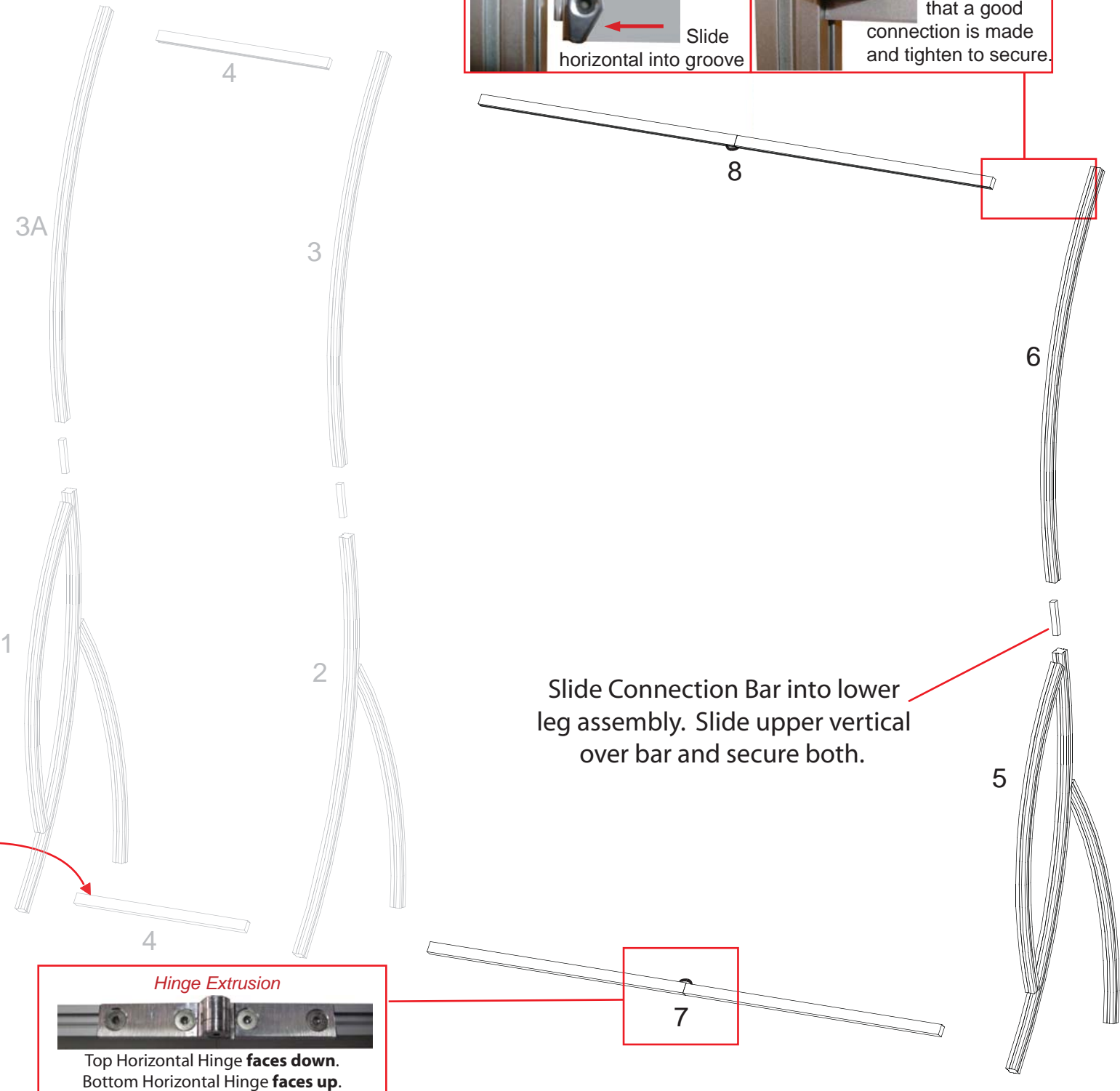
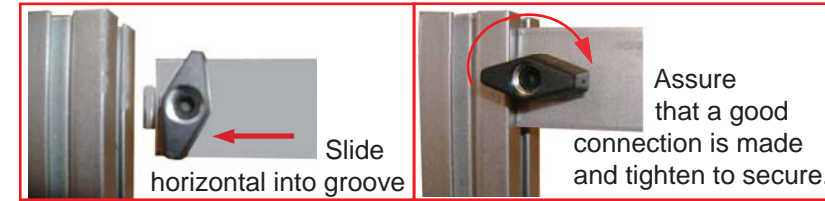

Rear View of Display

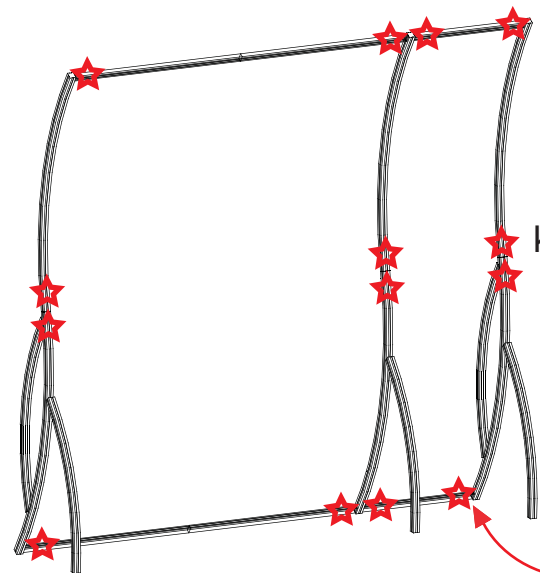

STAR indicates location of knobs on BACKSIDE of unit.

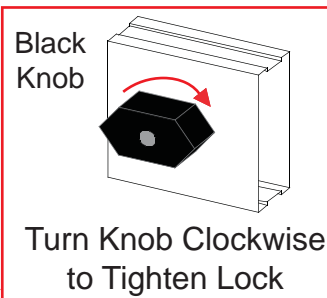

Slide Connection Bar into lower leg assembly. Slide upper vertical over bar and secure both.

WHEN DISASSEMBLING TIGHTEN ALL KNOBS TO PREVENT LOSS DURING SHIPPING

866.652.2100

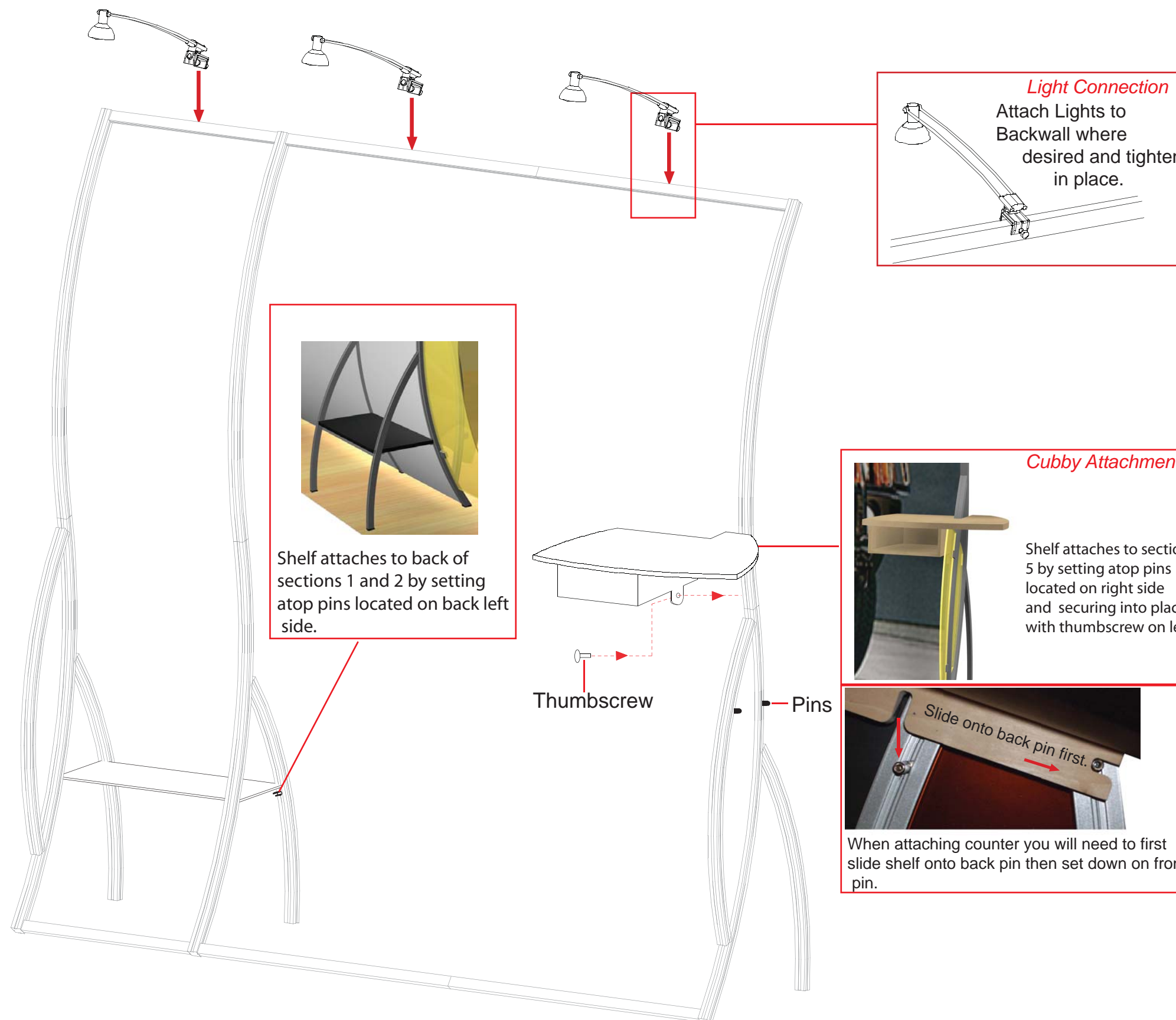

**Light Connection**  
 Attach Lights to Backwall where desired and tighten in place.

Shelf attaches to back of sections 1 and 2 by setting atop pins located on back left side.

**Cubby Attachment**  
 Shelf attaches to section 5 by setting atop pins located on right side and securing into place with thumbscrew on left.

Slide onto back pin first.  
 When attaching counter you will need to first slide shelf onto back pin then set down on front pin.

WHEN DISASSEMBLING TIGHTEN ALL KNOBS TO PREVENT LOSS DURING SHIPPING

Part Number	Description
A	Left Leg Assembly
B	Right Leg Assembly
C	Horizontal Extrusion
D	Horizontal Extrusion w/ Door Stopper

Step 1:

- A) Connect lower horizontal extrusion [C] between bottom of leg assemblies [A and B] as shown.
- B) Insert Laminated infill into grooves of leg assemblies [A and B].
- C) Attach extrusion door between leg assemblies [A and B] and atop laminated infill.
- D) Attach upper horizontal extrusion w/ door stopper [D] between leg assemblies [A and B], and set flush with top of legs [A and B].

**NOTE: Make sure the lock is flush with extrusion before tightening. If lock will not fully engage, gently rock lock and extrusion back and forth while turning knob until lock fully opens.**

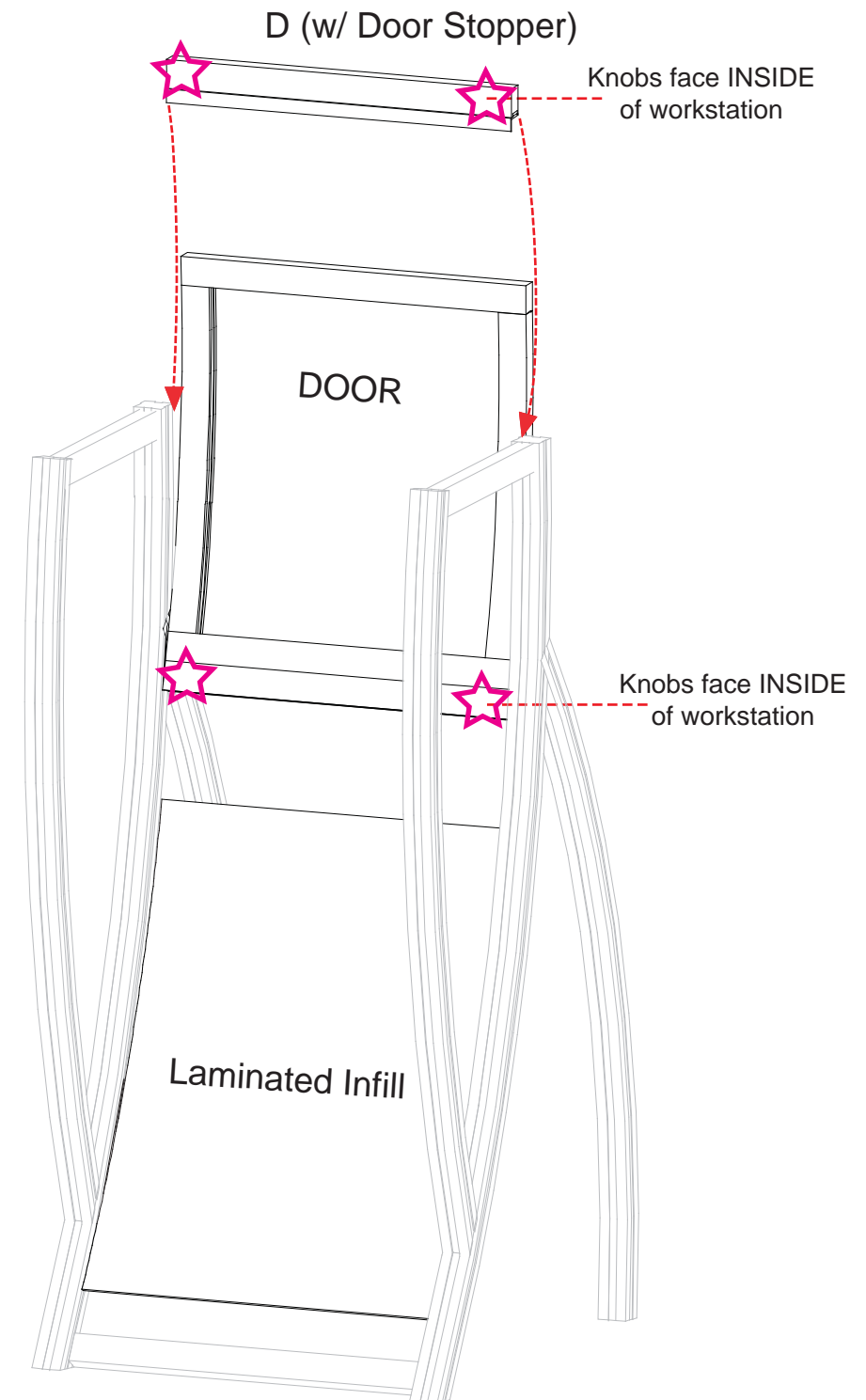
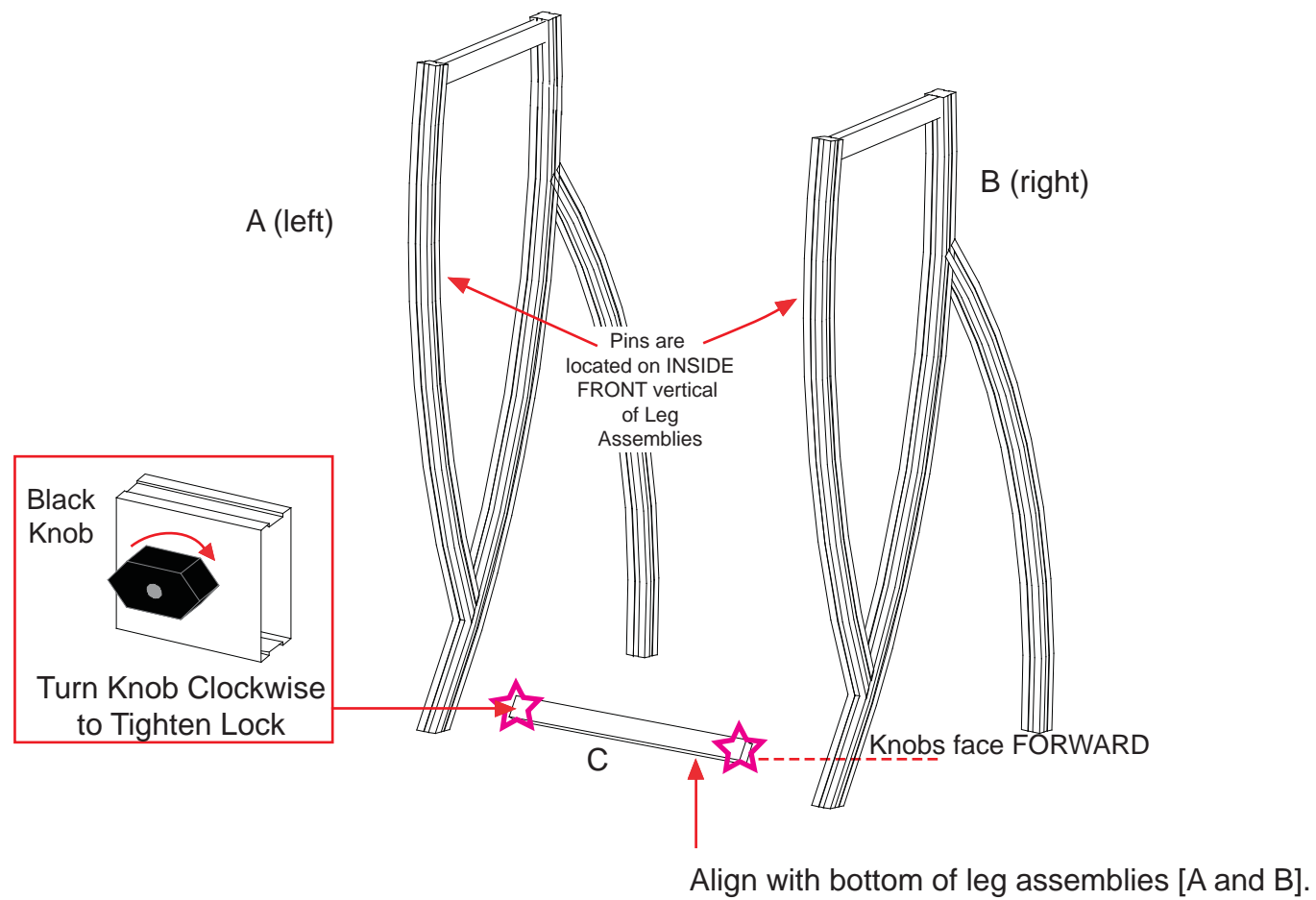

**WHEN DISASSEMBLING TIGHTEN ALL KNOBS TO PREVENT LOSS DURING SHIPPING**

866.652.2100

Part Number	Description
E	Horizontal Extrusion
F	Horizontal Extrusion

Step 2:

- A) Attach horizontal extrusion [E] between vertical leg assemblies [A and B] as shown below.
- B) Insert Laminated infill into grooves of vertical leg assemblies [A and B].
- C) Attach upper horizontal extrusion [F] between vertical leg assemblies [A and B] atop infill.
- D) Place internal shelf into assembled pedestal atop pins..
- E) Set Counter atop assembled pedestal and secure with Velcro straps attached to underside of top.

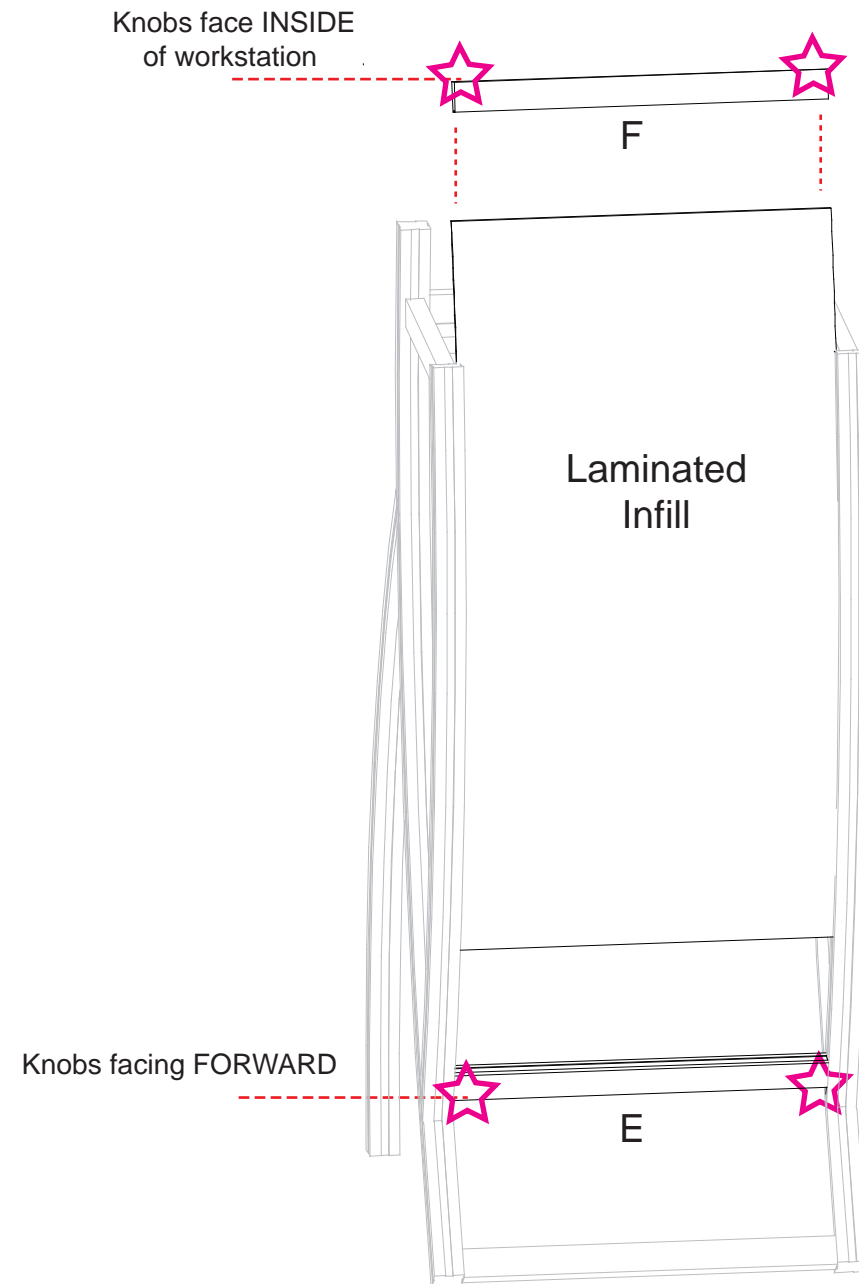

Place internal shelf into workstation then place counter atop assembled workstation.

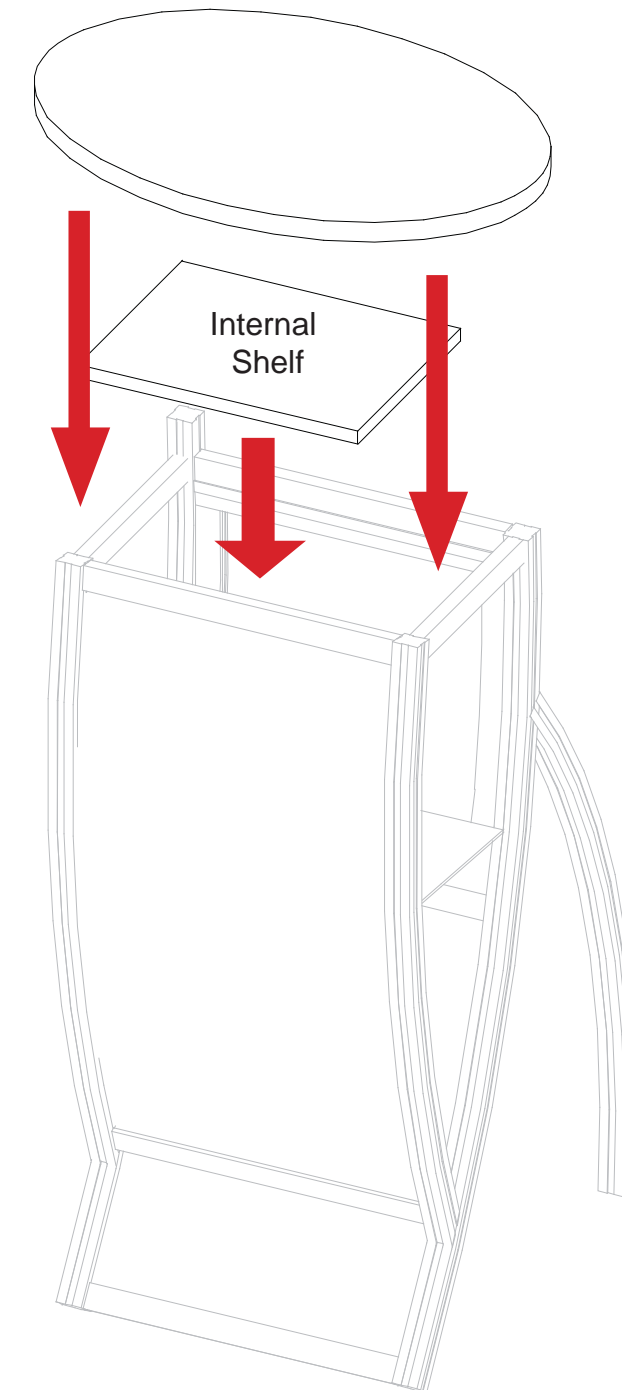

WHEN DISASSEMBLING TIGHTEN ALL KNOBS TO PREVENT LOSS DURING SHIPPING

Case #1 - Backwall Components

Top View of each Level

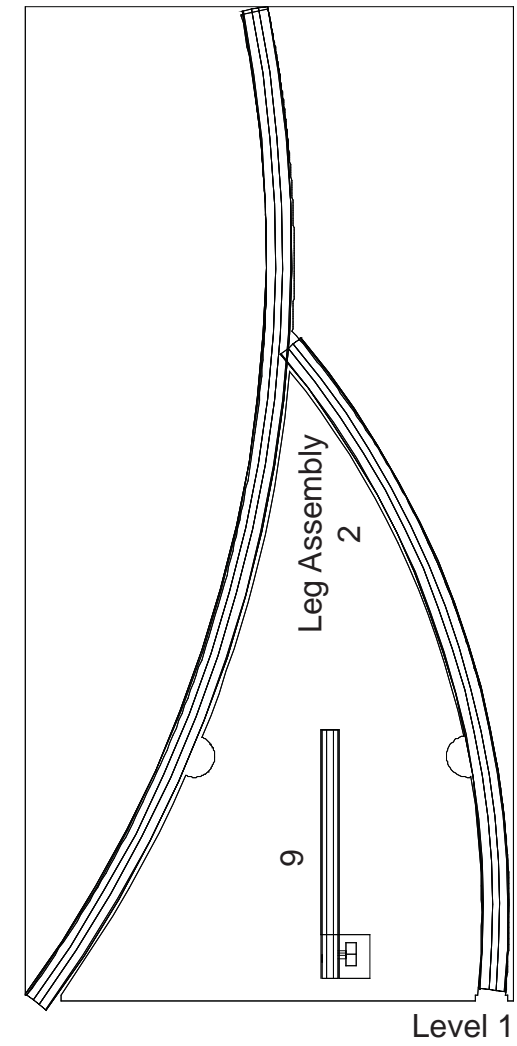
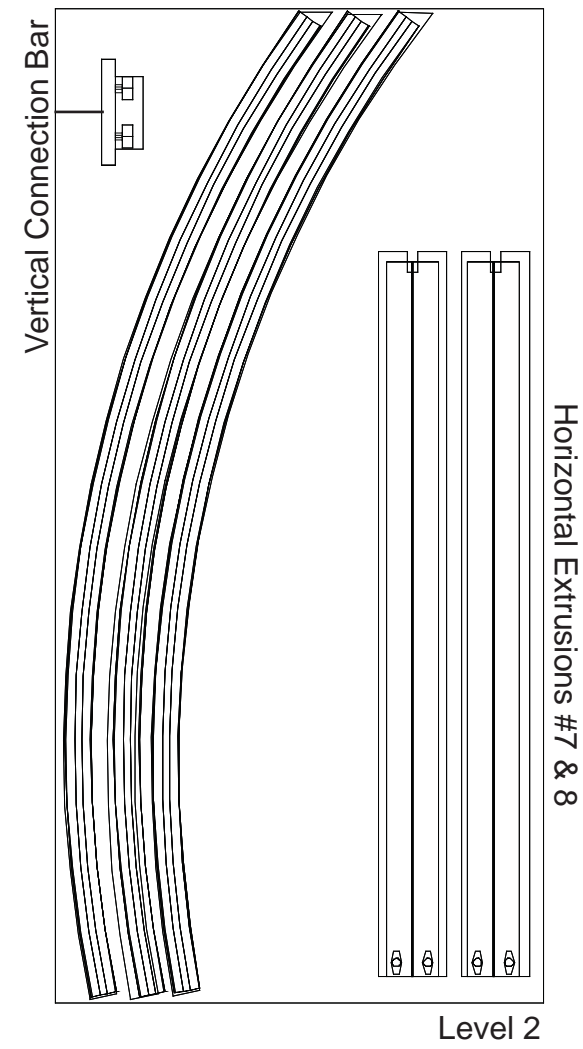
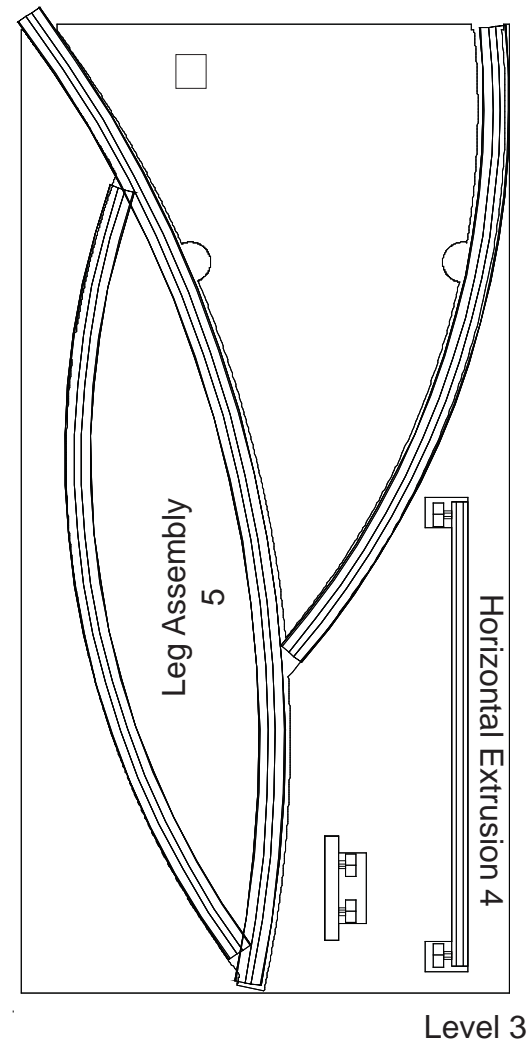
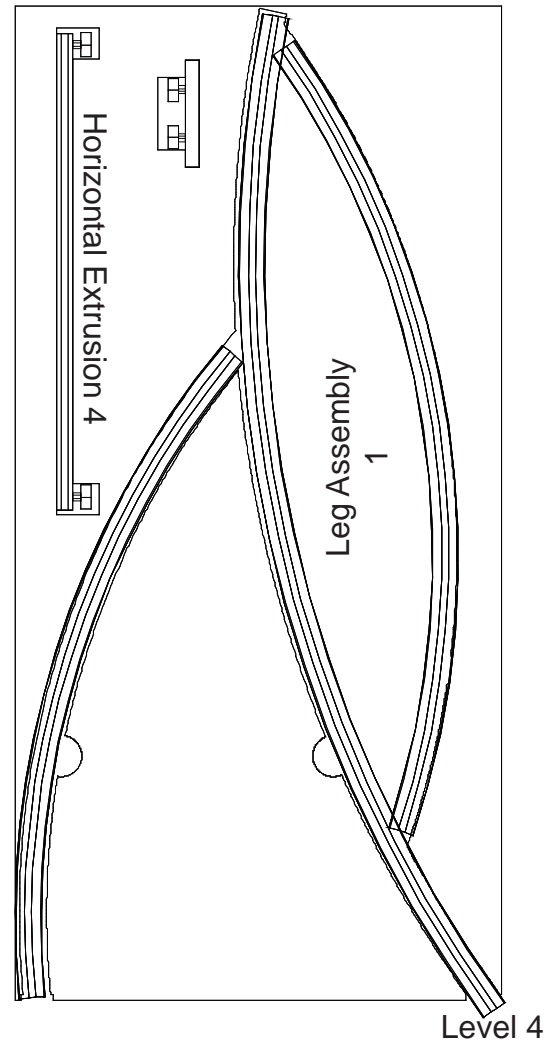

- Additional Items:**
- Setup Hardware
  - Graphic
  - (3) Lights

WHEN DISASSEMBLING TIGHTEN ALL KNOBS TO PREVENT LOSS DURING SHIPPING

Case #2 - Backwall Components

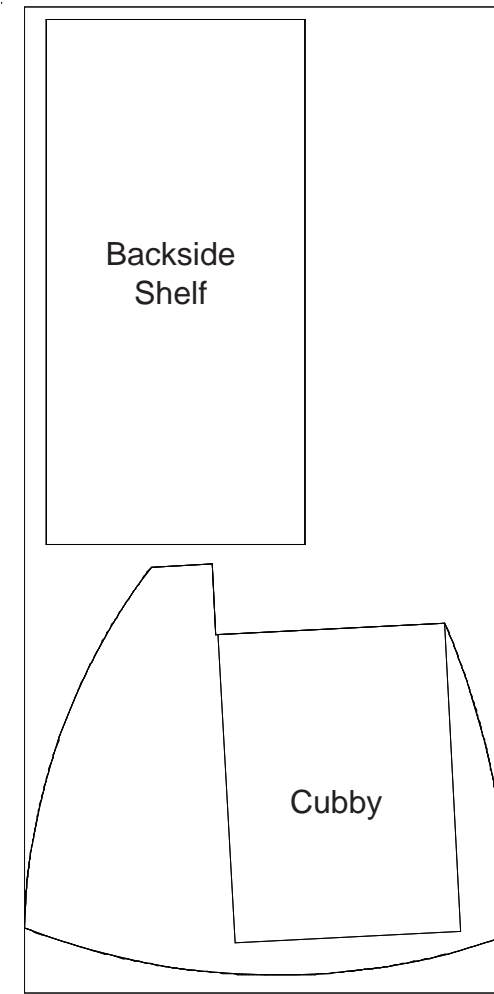

Level 1

- Additional Items:*
- Setup Hardware
  - Graphic
  - (3) Lights

WHEN DISASSEMBLING TIGHTEN ALL KNOBS TO PREVENT LOSS DURING SHIPPING

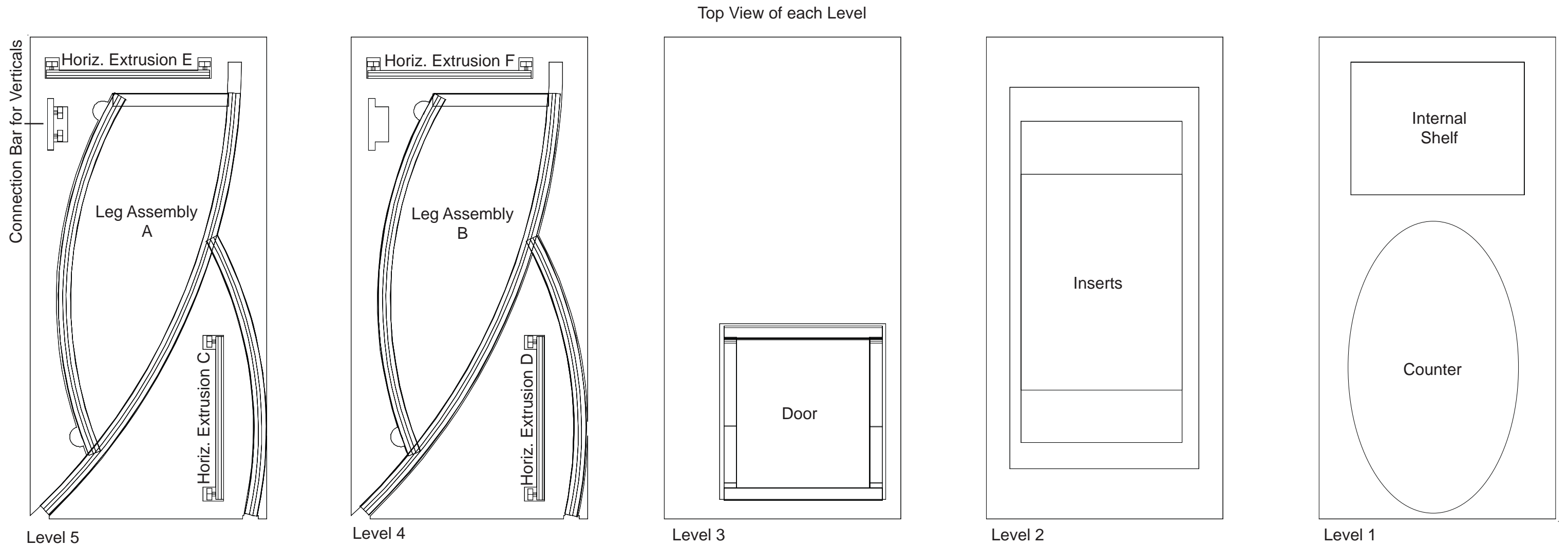

WHEN DISASSEMBLING TIGHTEN ALL KNOBS TO PREVENT LOSS DURING SHIPPING