

General Setup Instructions

Using Your Setup Instructions

The Setup Instructions are created specifically for your configuration. They are laid out sequentially in levels, including exploded views, and a logical series of detailed steps to assemble the main structure and components. We encourage you to study the instructions **before** attempting to assemble your exhibit.

Each page reminds you to tighten the setscrews after disassembling your exhibit to prevent loss of the locks and setscrews (see below in RED). This is VERY IMPORTANT.

Cleaning and Packing Your Display

- 1) Use care when cleaning aluminum extrusion or Eco Glass inserts. Use only non-abrasive cleaners.
- 2) When cleaning laminate inserts, countertops, or panels use mild cleansers and a soft material such as cotton.
- 3) Keep all display components away from extreme heat and long exposure to sunlight to avoid warping and fading.
- 4) Retain all packing material. It will make re-packing much easier and will reduce the likelihood of shipping damage. Each Layer will be labeled with the packing order.

General Setup Instructions for Panel System

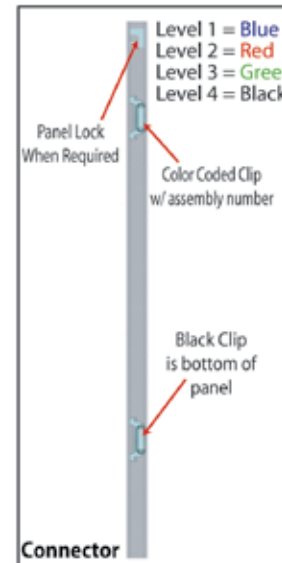

Each component has 2 clips, the lower clip is ALWAYS black. The top clip is color coded to distinguish the level. The color coded clip also contains the numbered label.

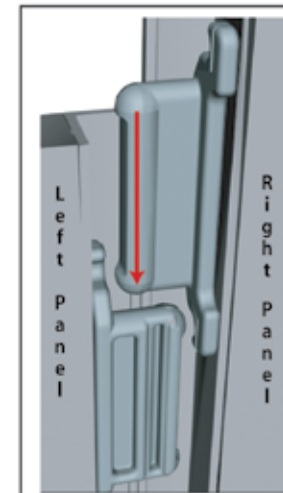

Cut Away View Of Slide Clips

Components connect together by aligning them and sliding downward connecting clips together.

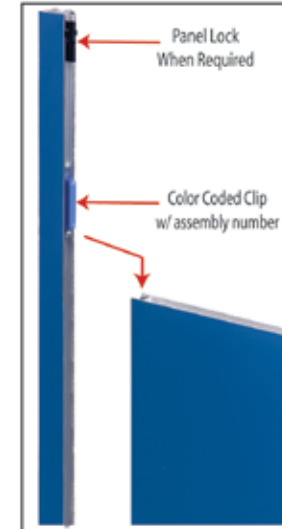

Example of Connection

Configurations are assembled from left to right, usually starting with #1 and following the numbered sequence.

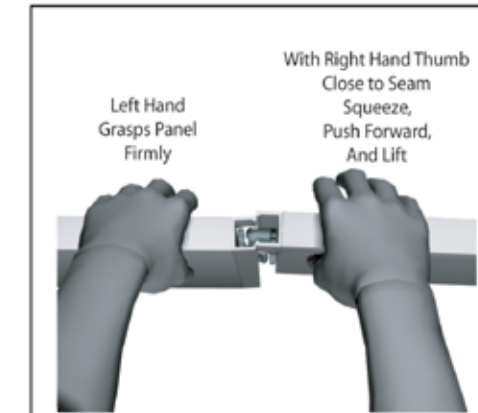

Top View of Panels with Locks

The first level of components contains panel locks that are located at the top of the panel for extra stability and a seamless connection. When disassembling panels, twist top connection slightly and lift right panel upward.

General Setup Instructions for Extrusion System



The Tool

Most exhibits can be assembled with the supplied Hex Key Tool. Occasionally, other tools may be needed.



Typical Connection

Most horizontal extrusion connections have a patented expandable lock. This lock inserts into the groove of an opposing extrusion. Tightening the lock with the Hex Key Tool expands the lock and creates a strong positive connection.



Typical Connection (cont'd)

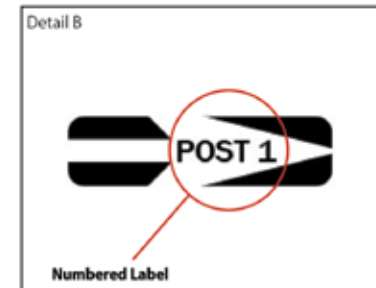

Numbered Label

Each extrusion contains a numbered label which corresponds with setup instructions. The label is located within a groove of the extrusion (when possible). With extrusion components the labels contain Black numbers unless otherwise specified.

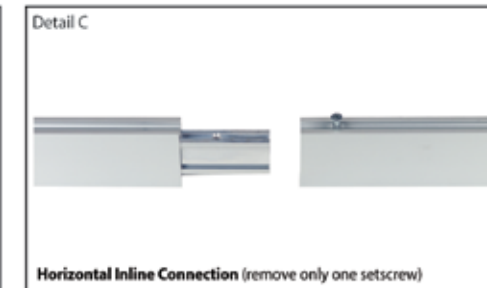

Horizontal Inline Connection (remove only one setscrew)

Remove only (1) setscrew when disassembling. Replace setscrew in extrusion after assembling it. Before packing, replace setscrew in extrusion to avoid losing it.

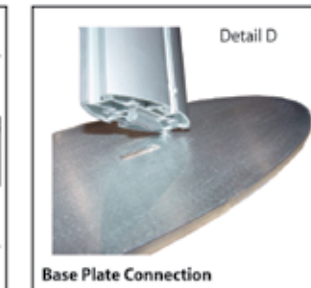

Base Plate Connection

Attach base plate to vertical extrusion using the lock provided. Place base plate on ground and set vertical post/lock in base plate slot. Tighten lock with Multitool.

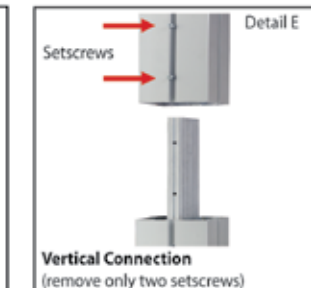

Vertical Connection (remove only two setscrews)

When vertical extrusions are packed in portable cases rather than crates or tubs, they must be broken down into smaller sections which then require assembly.

Remove only (2) setscrews when disassembling. Replace setscrews in extrusion after assembling it. Before packing, replace setscrews in extrusion to avoid losing them.

WHEN DISASSEMBLING ALUMINUM EXTRUSION, TIGHTEN ALL SETSCREWS AND LOCKS TO PREVENT LOSS DURING SHIPPING

Item Number	Qty.	Description
1	4	Base Plate
2	4	42" h Vertical Extrusion
3	4	42" h Vertical Extrusion
4	1	44" h Vertical Extrusion with Extrusion Attached
5	1	44" h Vertical Extrusion with Extrusion Attached
6	1	44" h Vertical Extrusion with Extrusion Attached
7	1	44" h Vertical Extrusion with Extrusion Attached
8a/8b	4	29.5" w Curved Horizontal Extrusion
9	4	38" w Horizontal Extrusion

Steps:

- 1) Attach base plates to bottom of verticals per illustration below, see Detail D on General Instruction page.
- 2) Connect vertical extrusions and horizontal extrusions together as shown.
- 3) Connect horizontal extrusions between vertical assemblies.
Velcro side must face forward
- 4) Attach shelves to backwall as shown.
- 5) Attach Monitor Mounts to backwall as shown.

* Attach shelf to vertical and tighten lock to secure in place.



Note: Attaching Graphics
Attach Backwall Graphics to Velcro on the Top Edge of the Upper Horizontals and on the Bottom Edge of the Lower Horizontals

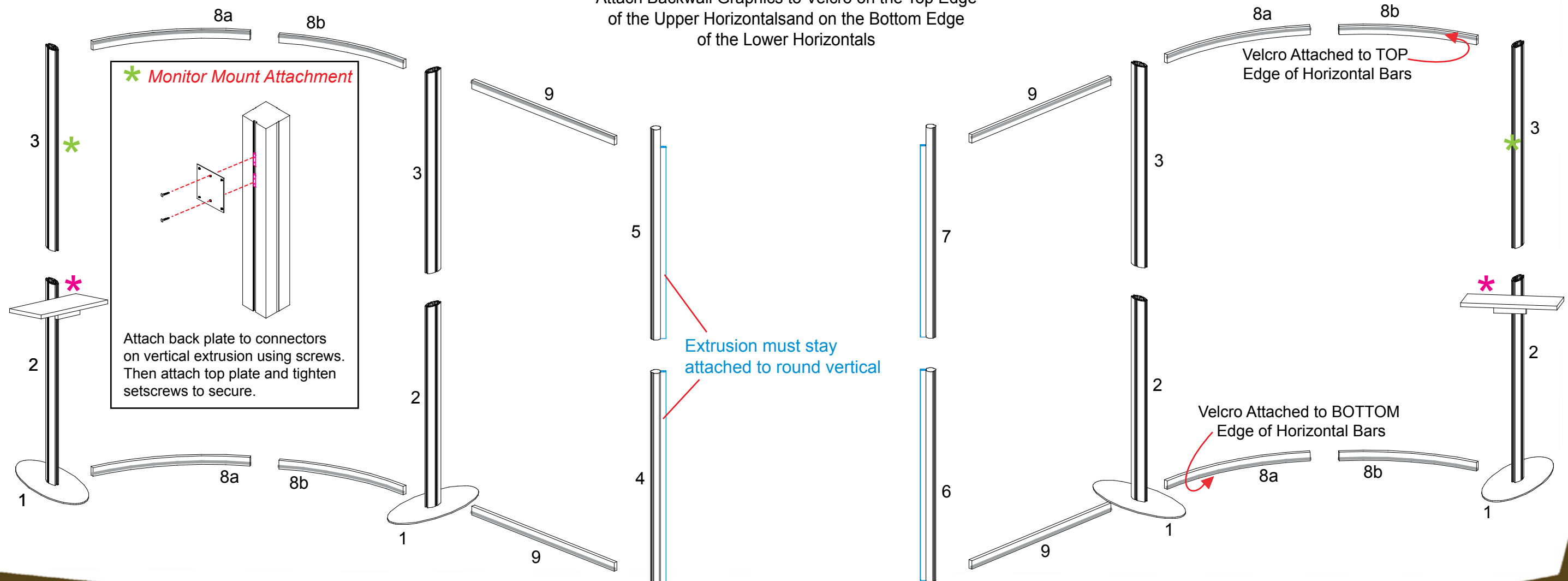

Clip Connection Panels

Item Number	Description
1	22" w x 42" h Flat Panel
2	22" w x 42" h Flat Panel
1	22" w x 42" h Flat Panel
2	22" w x 42" h Flat Panel

Steps:

- 1) Connect panel #1 to connector on vertical [4] then lock panel #2 between panel #1 and connector on vertical [6]
- 2 Repeat step for upper level panels.

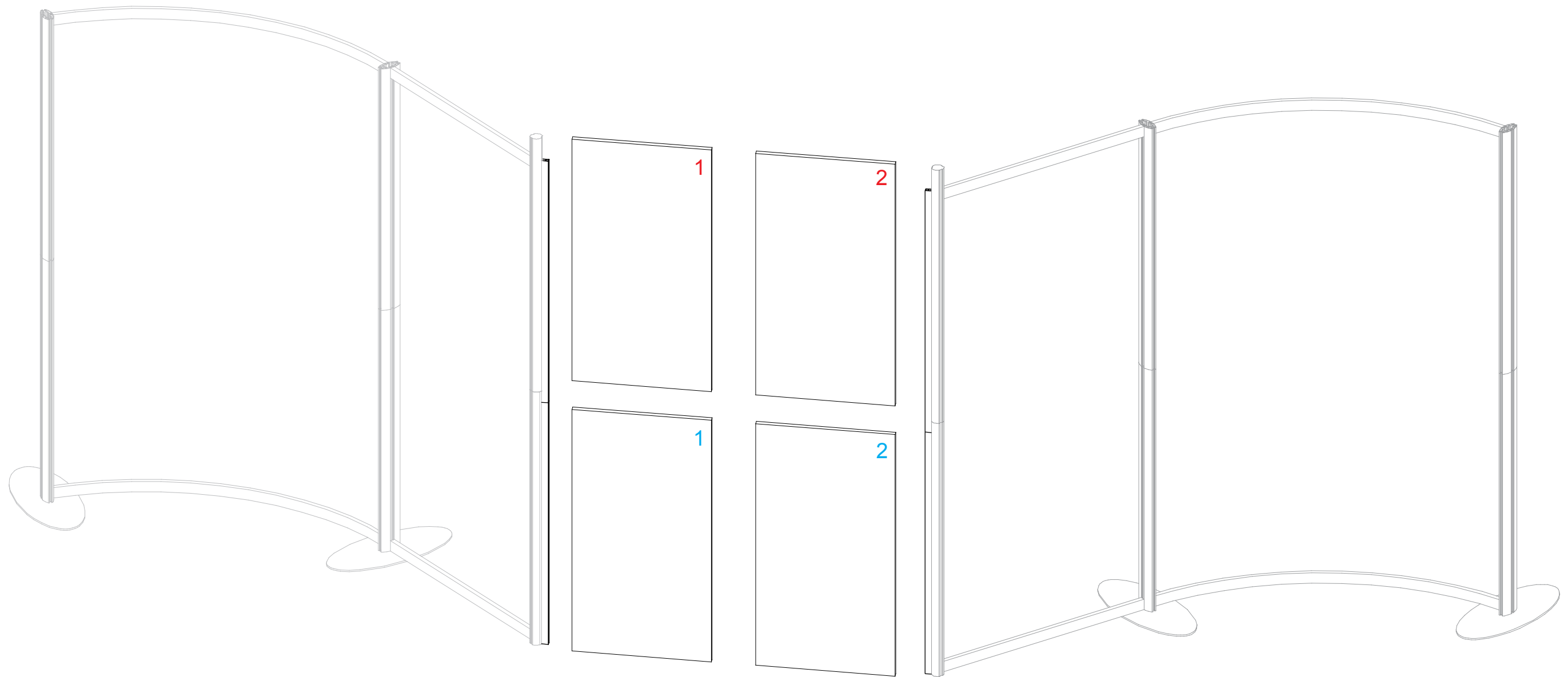

Item Number	Qty.	Description
1	2	Base Plate
10	2	42" h Vertical Extrusion
11	2	42" h Vertical Extrusion
12	2	30" w Horizontal Extrusion
13a/13b	1/1	48.4" h Curved Horizontal Extrusion
14a/14b	1/1	48.4" h Curved Horizontal Extrusion
15	1	11.5" h Vertical Extrusion
16	1	11.5" h Vertical Extrusion
17	1	11.5" h Vertical Extrusion

Steps:

- 1) Attach base plates to bottom of verticals per illustration below, see Detail D on General Instruction page.
- 2) Connect vertical extrusions together as shown.
- 3) Connect vertical assemblies to backwall structure using horizontal extrusions [12].
- 4) Connect header pieces [13a/13b, 14a/14b, 15, 16 and 17] together as shown.
Velcro side must face forward and must be attached on edges of frame.
- 5) Lock assembled header between vertical assemblies as shown.
- 6) Attach shelves as indicated.
- 7) Attach Monitor Mounts as indicated.

* Attach shelf to vertical and tighten lock to secure in place.



* Monitor Mount Attachment

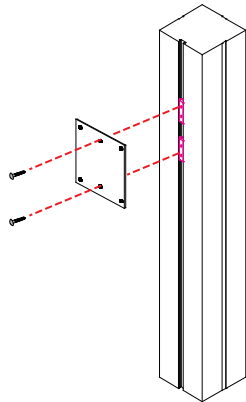

Attach back plate to connectors on vertical extrusion using screws. Then attach top plate and tighten setscrews to secure.

* Monitor Mount Attachment

Attach wall plate to panels using bolts and wing nuts

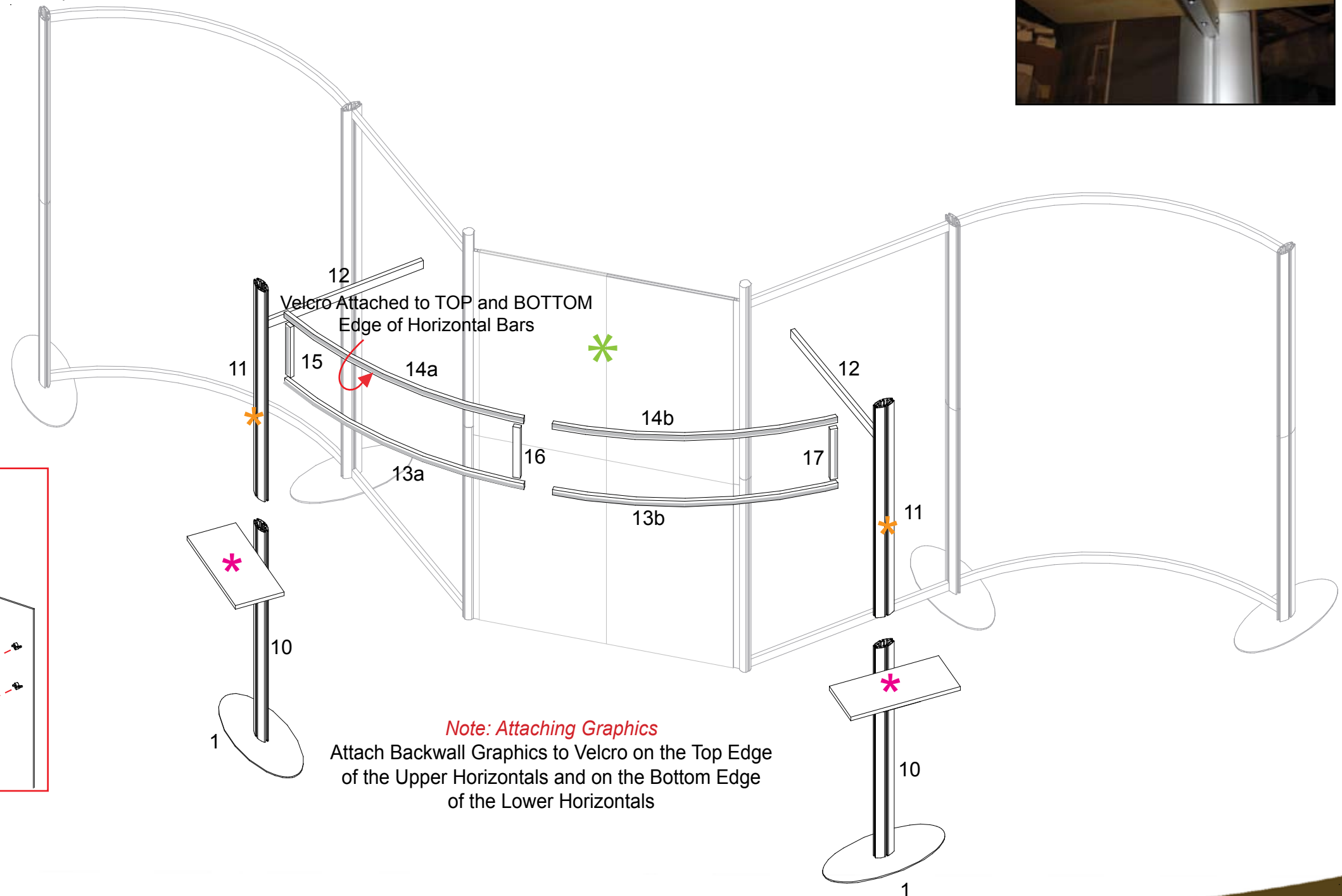
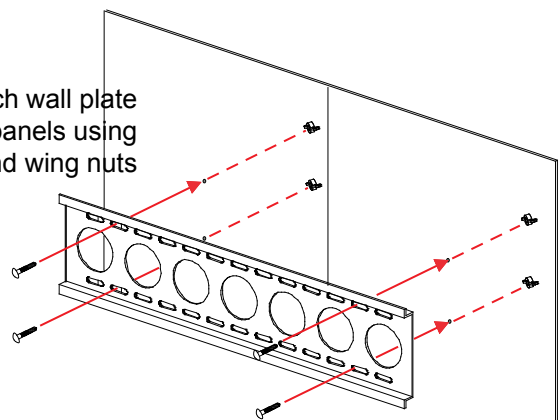

SMALL & LARGE CABINET SETUP INSTRUCTIONS

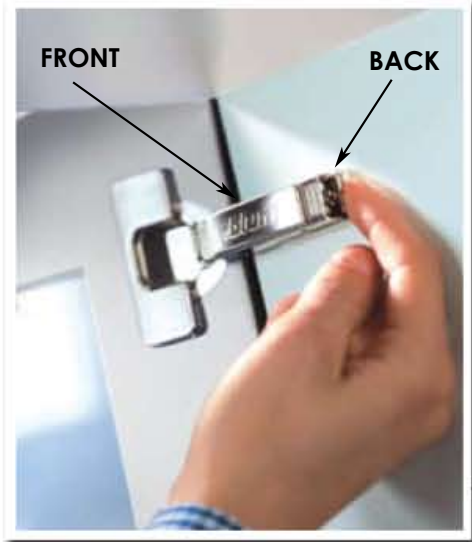

Cabinet Door(s) will clip into pre-installed base plate. Place front of hinge then clip back in place

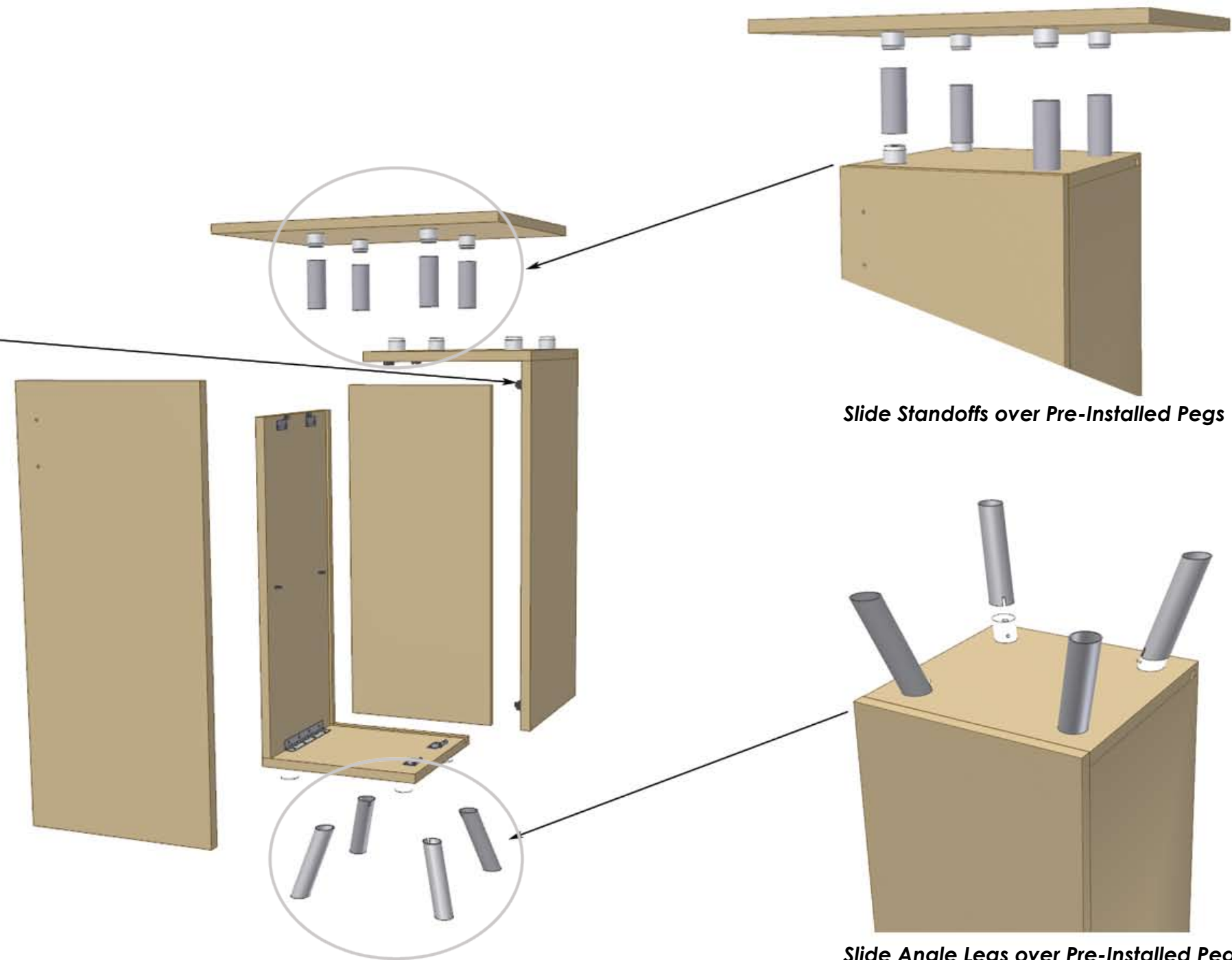

Slide Standoffs over Pre-Installed Pegs

Slide Angle Legs over Pre-Installed Pegs

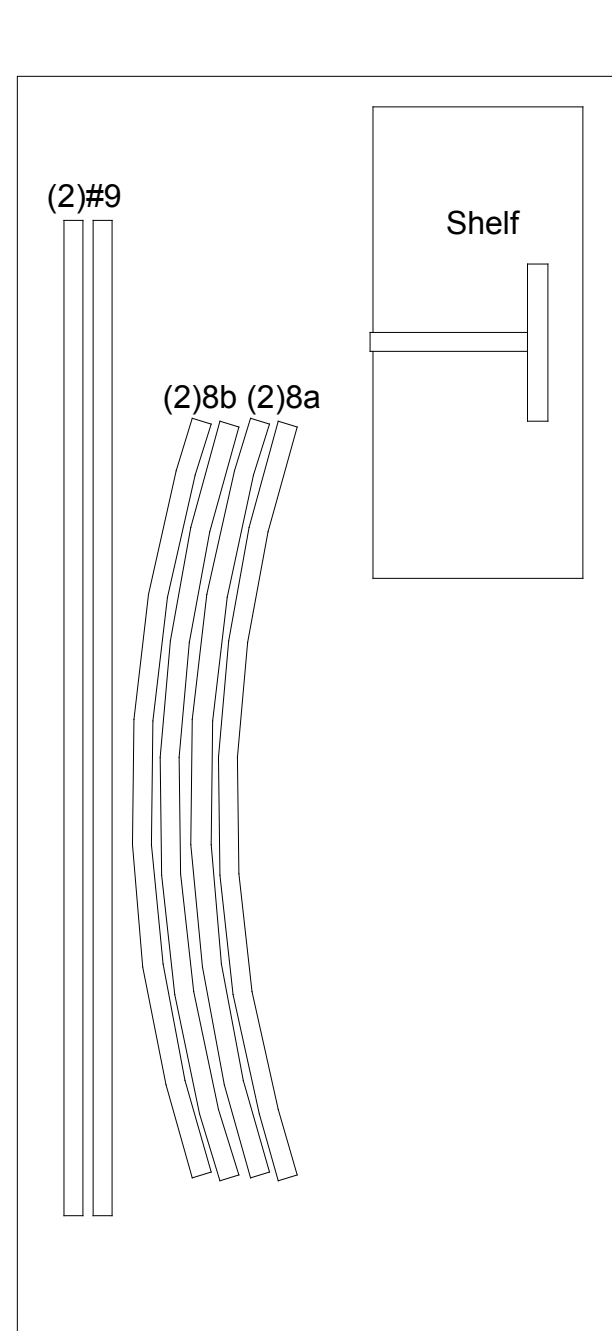

Level 1

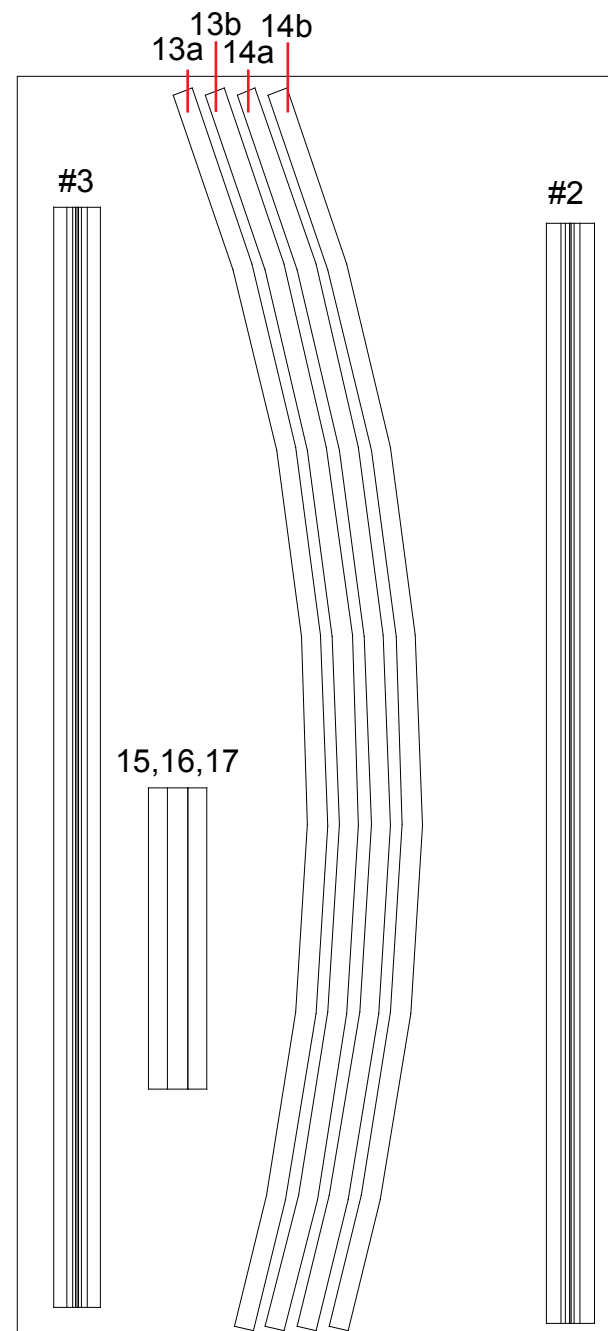

Level 2

Setup Hardware

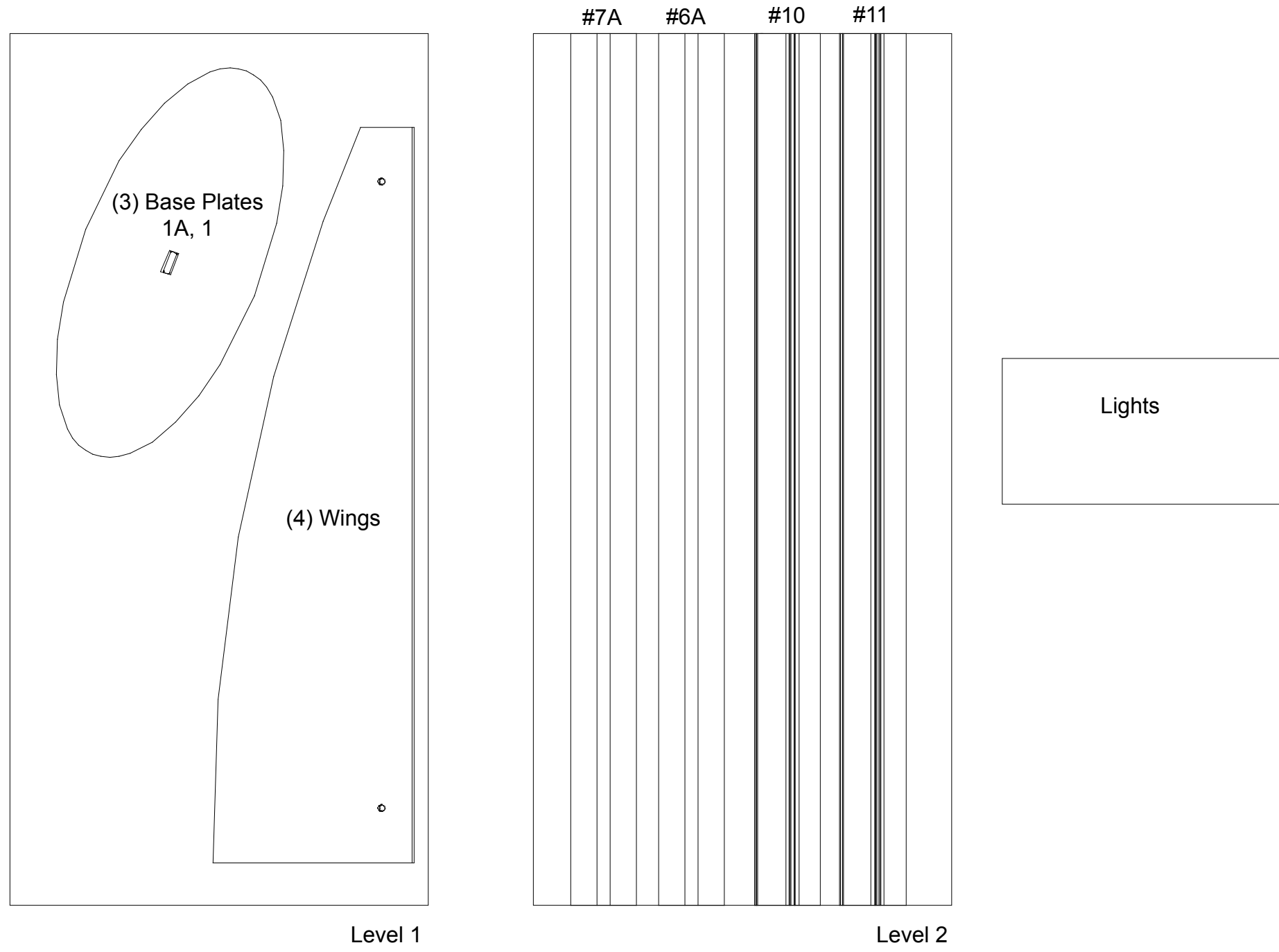

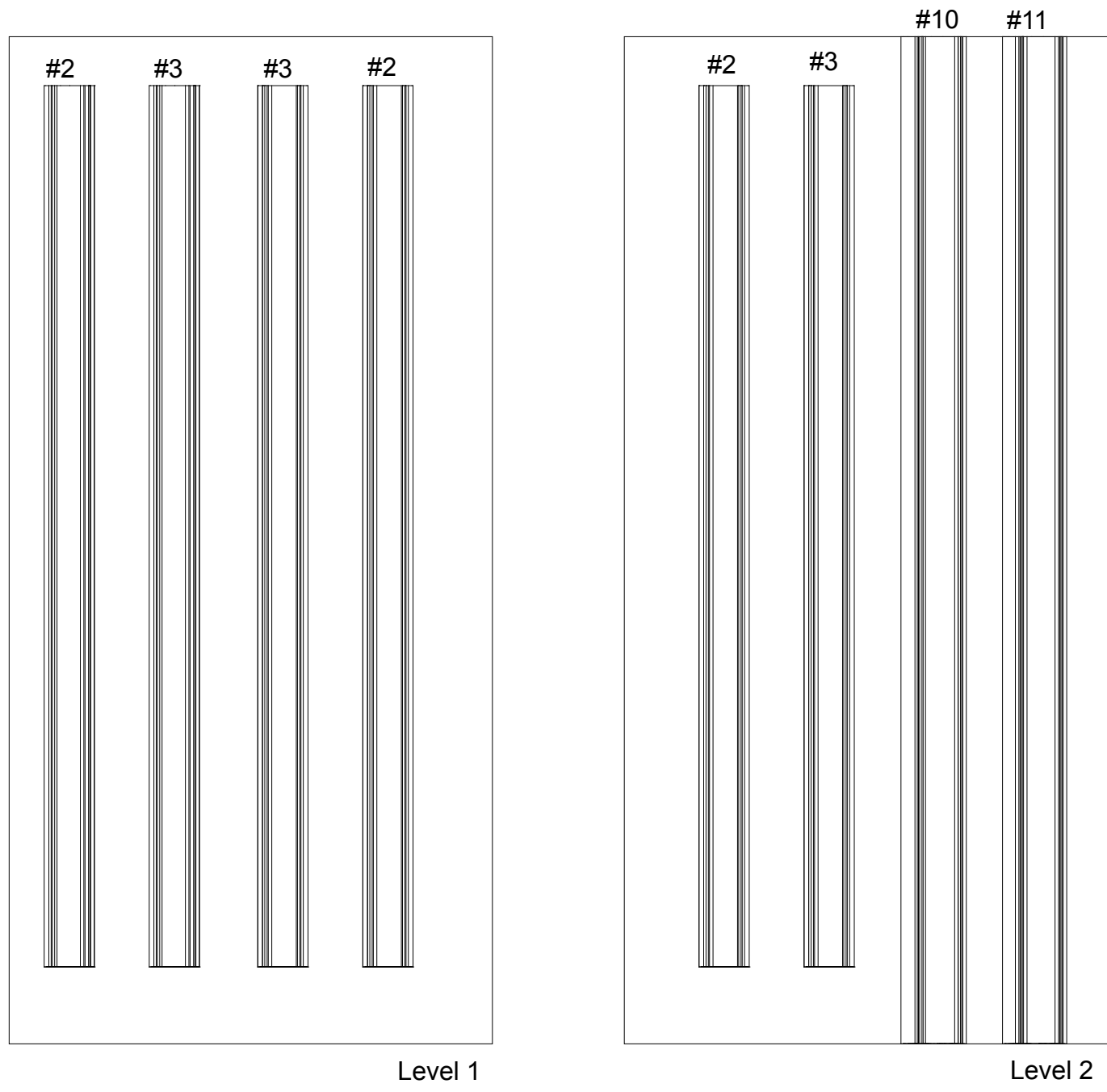

Level 1

Level 2

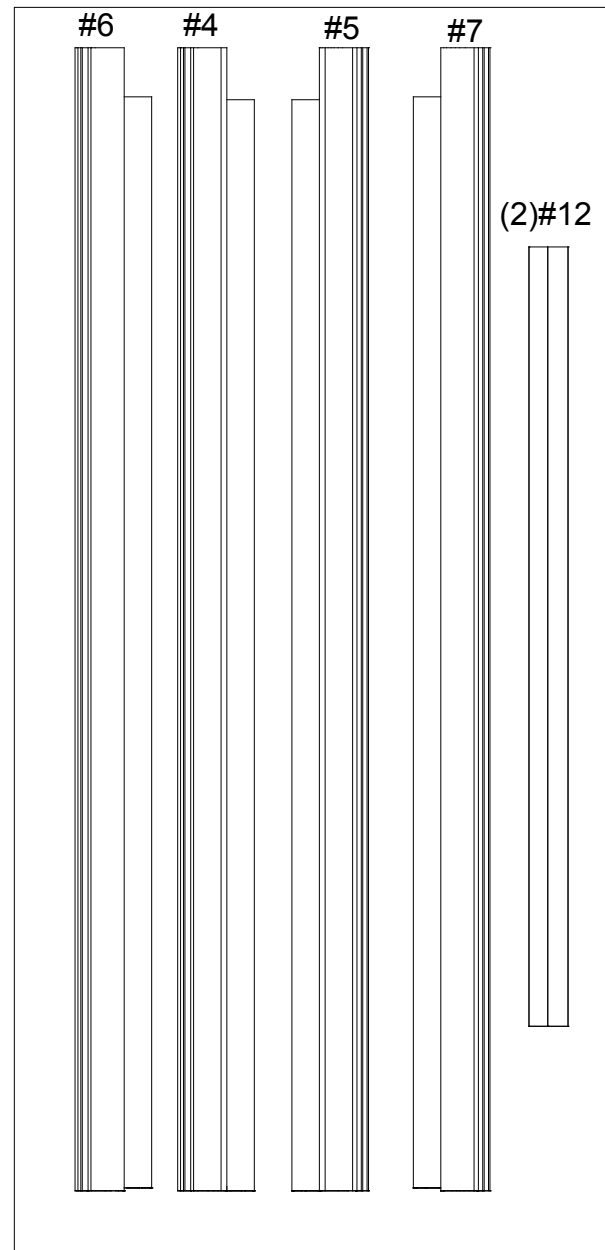

Level 1

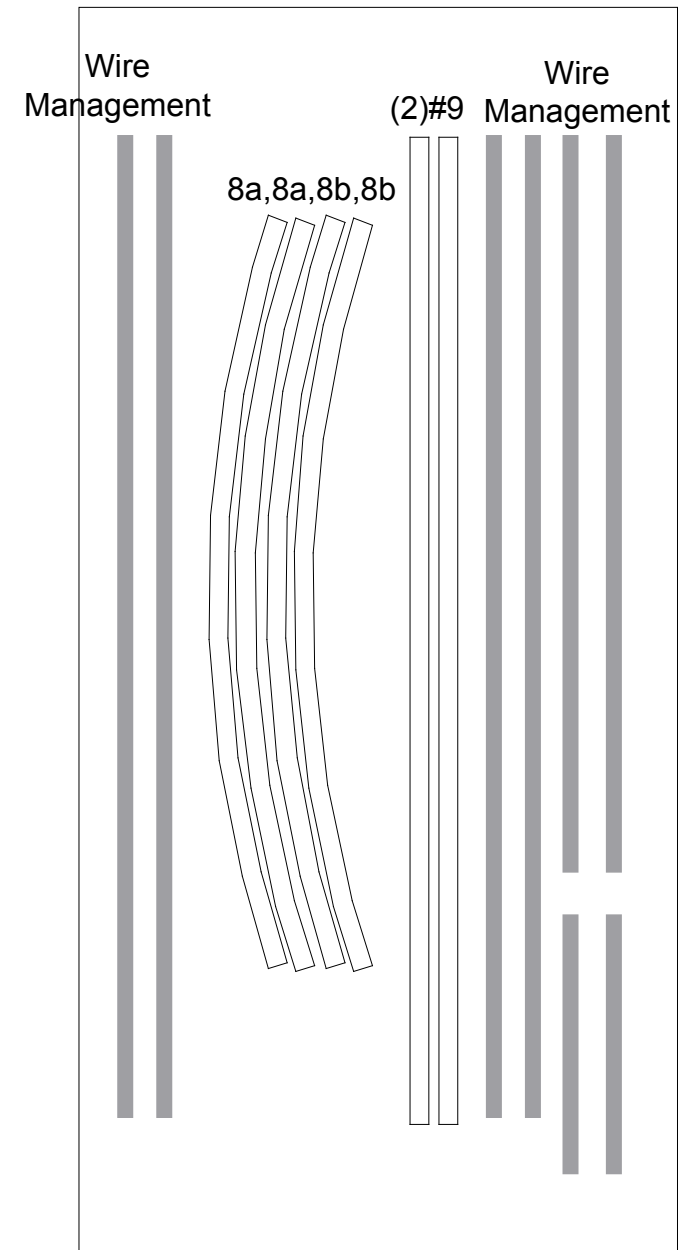

Level 2

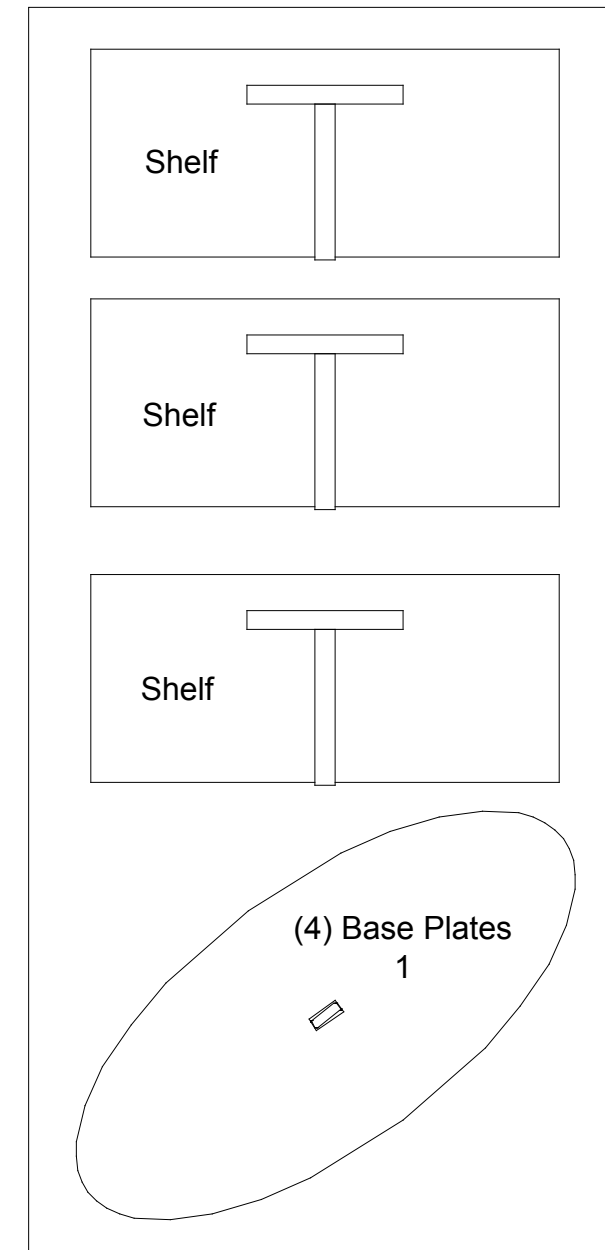

Level 3

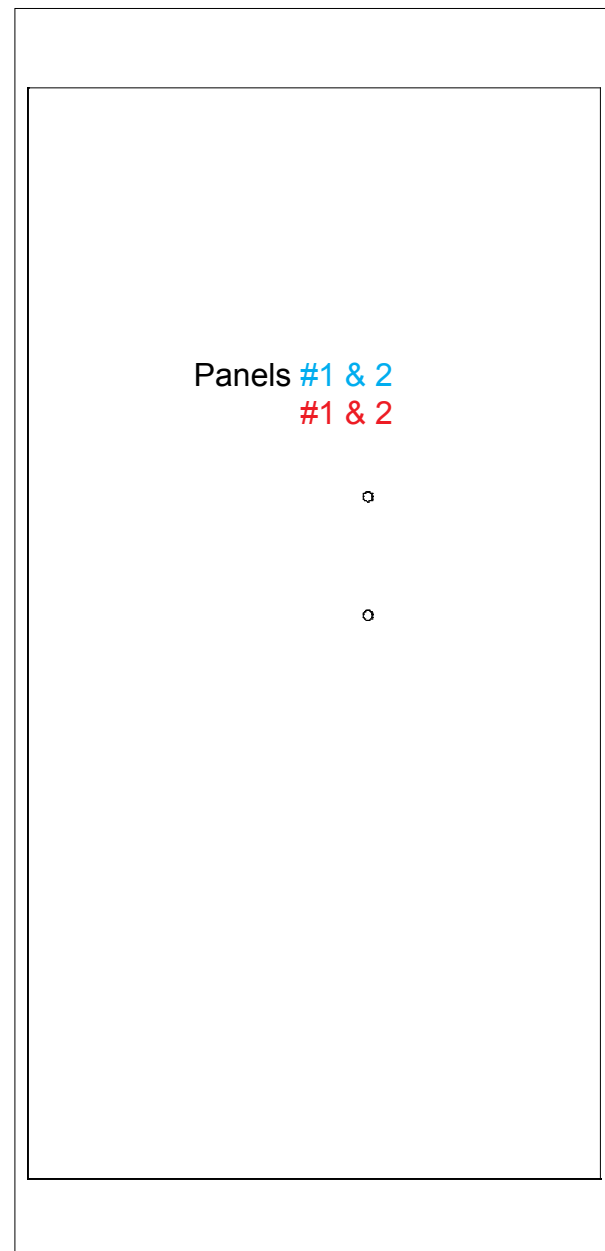

Level 1

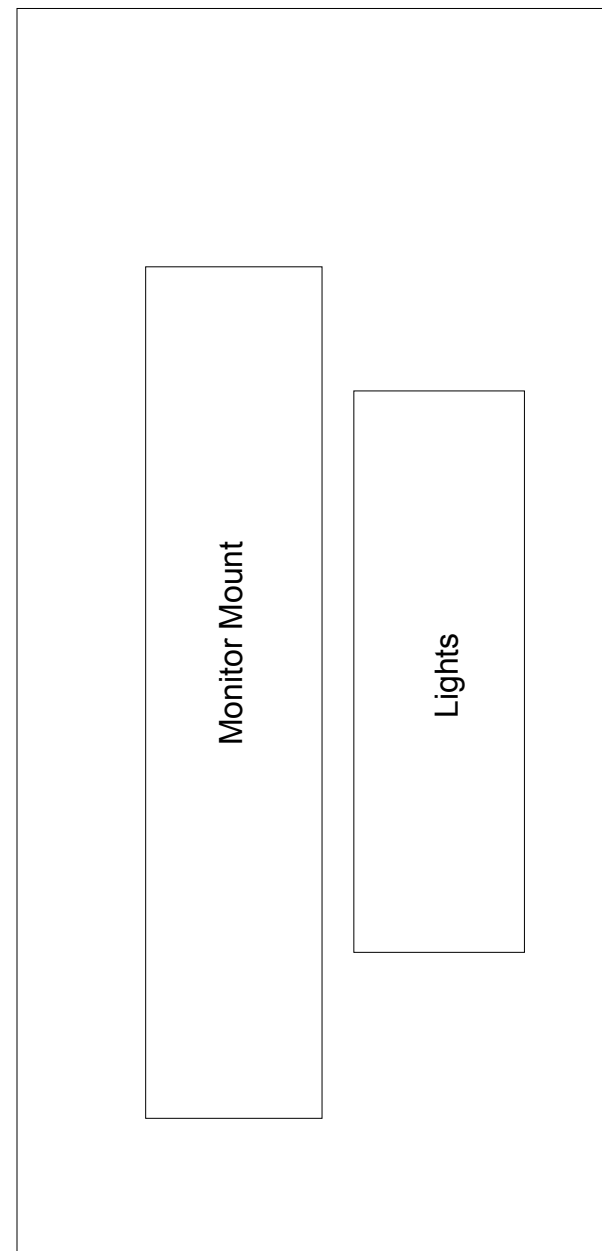

Level 2