

Perfect 10 Hybrid Displays

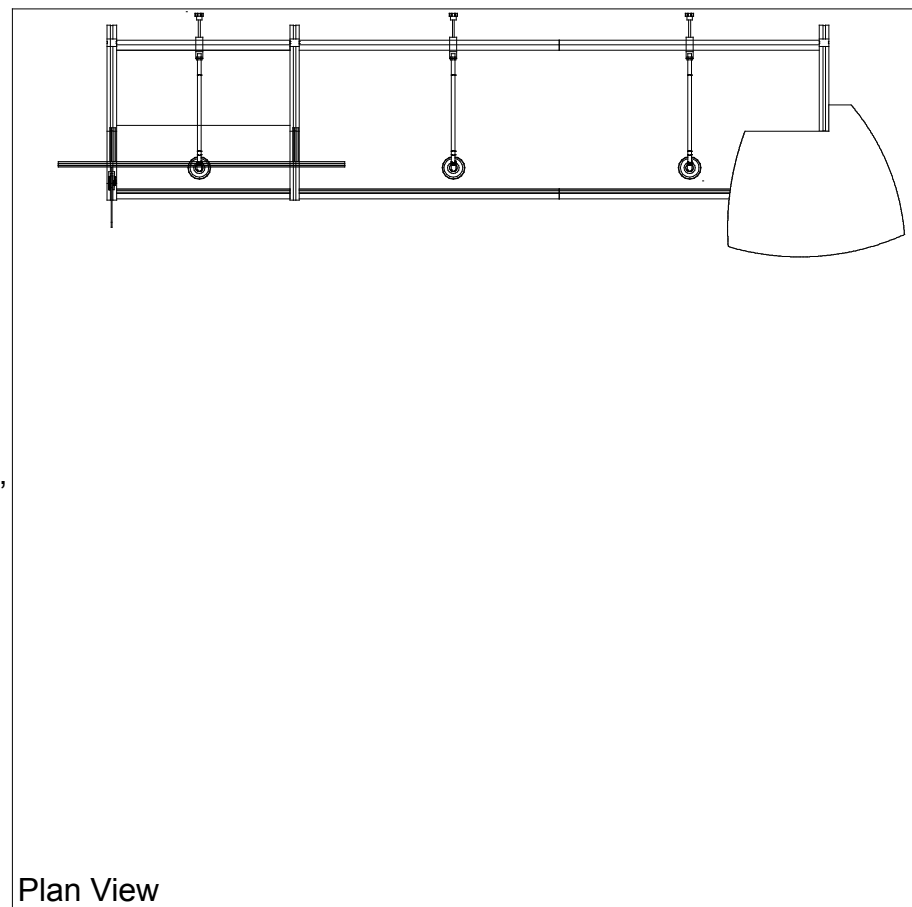

10'

10'

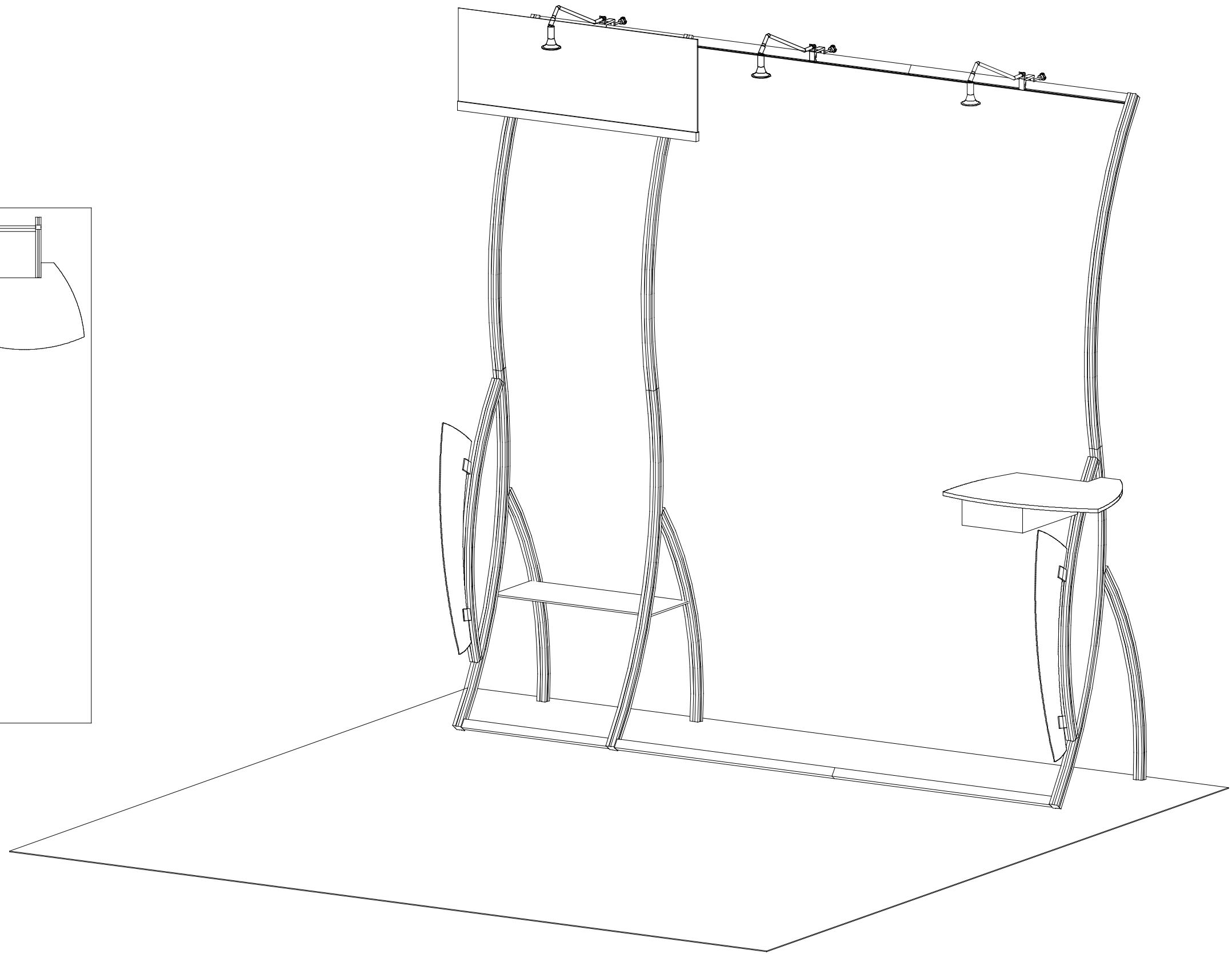

WHEN DISASSEMBLING TIGHTEN ALL KNOBS TO PREVENT LOSS DURING SHIPPING

866.652.2100

Part Number	Description
1	Left Leg Assembly w/ A10 Clamps Attached
2	Middle Leg Assembly
3A	Upper Curved Vertical
3	Upper Curved Vertical
4	23" w Horizontal

Step 1:

NOTE: Can be assembled either face down on floor then lifted upright or upright as shown in drawings.



- A) Connect vertical leg assemblies [1 and 2] together by connecting horizontal extrusions [4] between assemblies tightening BLACK knobs on backside of extrusion making sure Velcro faces toward BACK and placing it about one inch up from bottom and tightening.
- B) Connect vertical extrusions [3 and 3A] to leg assemblies [1 and 2] using vertical connection bar as shown.
- C) Connect upper horizontal extrusion [4] between verticals [3 and 3A] placing it about one inch down from top.

NOTE: Make sure the lock is flush with extrusion before tightening. If lock will not fully engage, gently rock lock and extrusion while turning knob until lock fully opens.

Rear View of Display

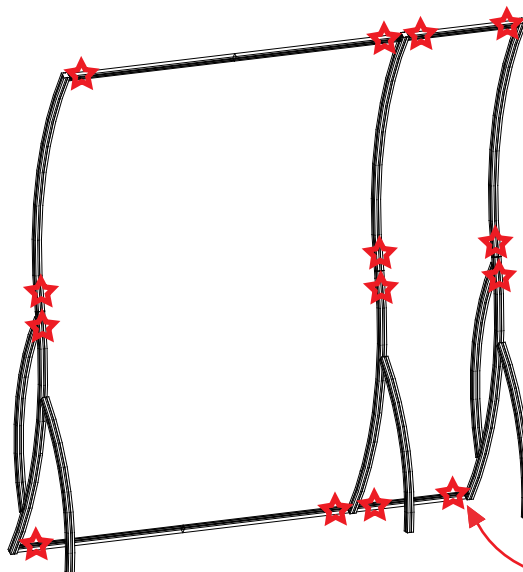

STAR indicates location of knobs on BACKSIDE of unit.

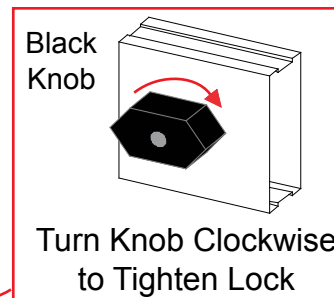

Black Knob

Turn Knob Clockwise to Tighten Lock

Step 1

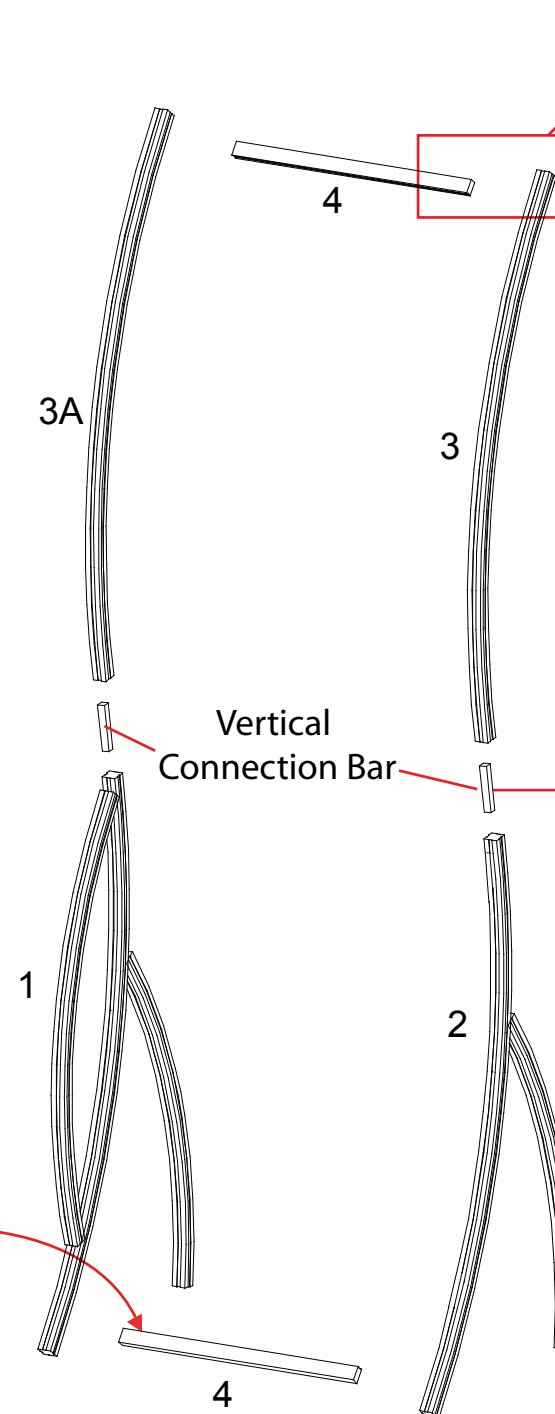

NOTE: When assembling horizontals they should be placed approximately one inch from TOP and BOTTOM.



Slide Connection Bar into lower leg assembly. Slide upper vertical over bar and secure both.

Step stool may be required for assembly.



WHEN DISASSEMBLING TIGHTEN ALL KNOBS TO PREVENT LOSS DURING SHIPPING

866.652.2100

Part Number	Description
5	Right Leg Assembly w/ A10 Clamps Attached
6	Upper Curved Vertical
7	69" w Horizontal w/ Hinge Facing UP
8	69" w Horizontal w/ Hinge Facing DOWN

Step 2

Step 2:
NOTE: Can be assembled either face down on floor then lifted upright or upright as shown in drawings.

- A) Connect vertical extrusion [6] to leg assembly [5] using vertical connection bar as shown.
- B) Connect horizontal extrusions [7 and 8] between vertical assemblies by tightening BLACK knobs on backside of extrusion making sure Velcro faces toward BACK.

NOTE: Make sure the lock is flush with extrusion before tightening. If lock will not fully engage, gently rock lock and extrusion while turning knob until lock fully opens.



NOTE: When assembling horizontals they should be placed approximately one inch from TOP and BOTTOM.

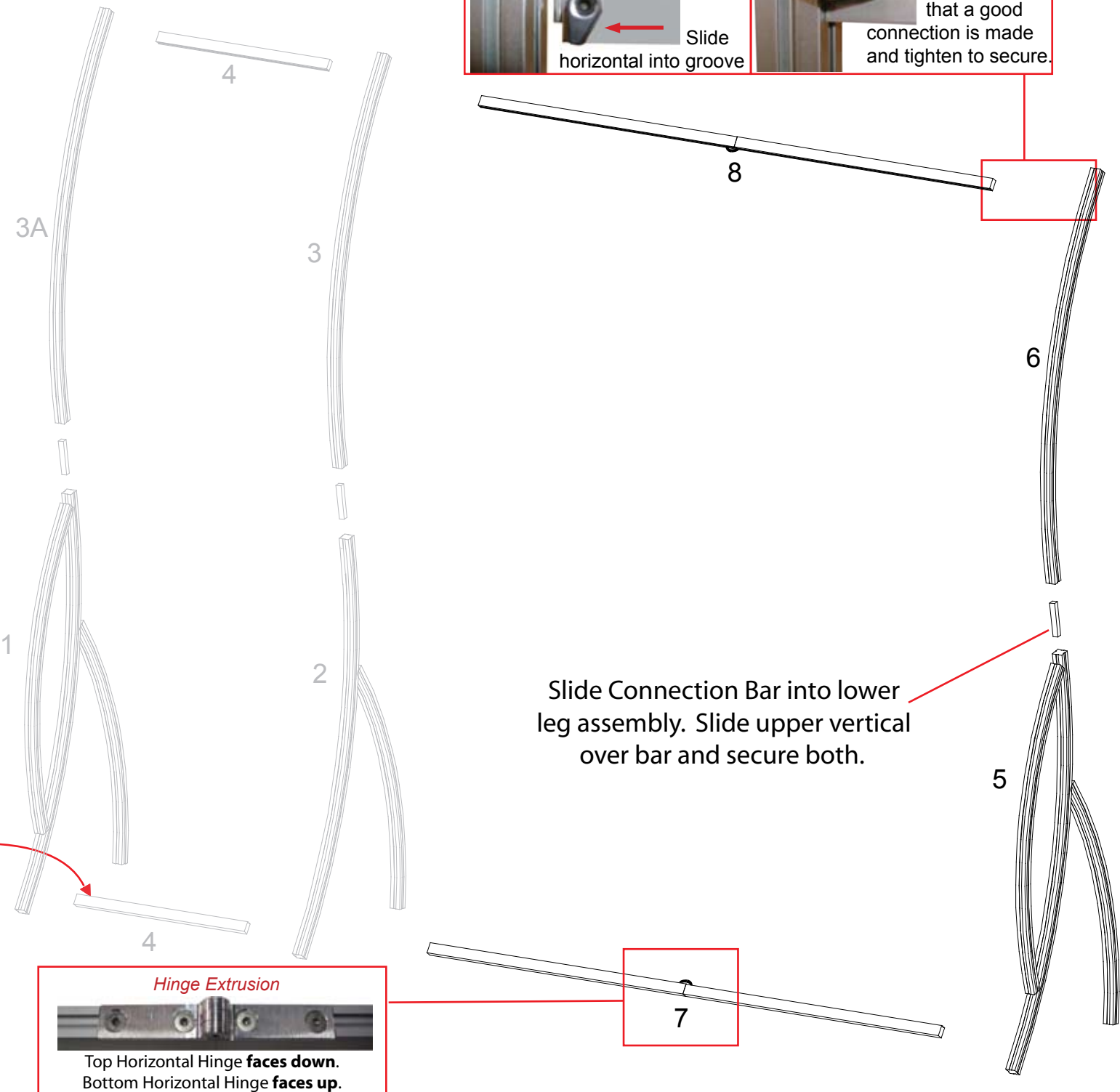

Rear View of Display

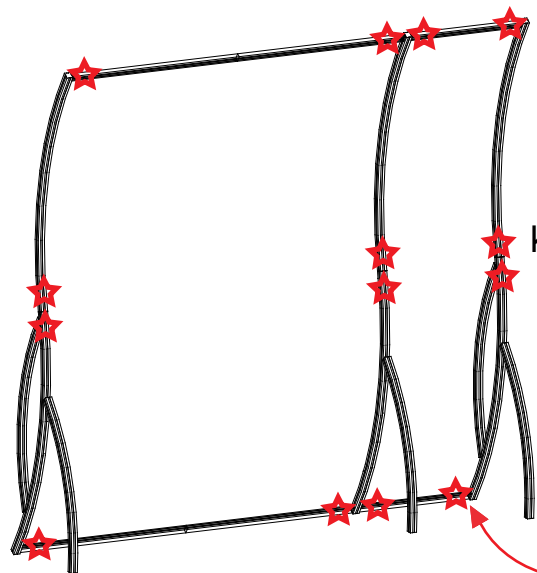

STAR indicates location of knobs on BACKSIDE of unit.

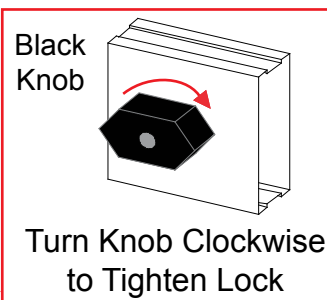

WHEN DISASSEMBLING TIGHTEN ALL KNOBS TO PREVENT LOSS DURING SHIPPING

*Decorative Blade Attachment
(if accidentally removed)*
Slide A10 Clamp into groove of square extrusion.

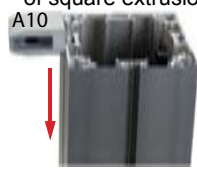

When desired location is found, tighten set screw to secure.





Tighten plastic knob to secure Wing in place.

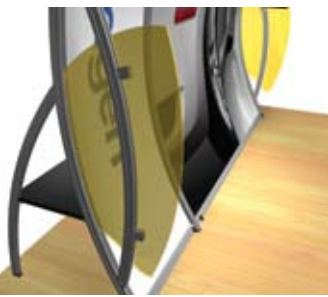

Attach decorative wing and blades to A10's attached to Backwall as shown.

Hex Key Tool
Flathead Screwdriver





(if necessary)

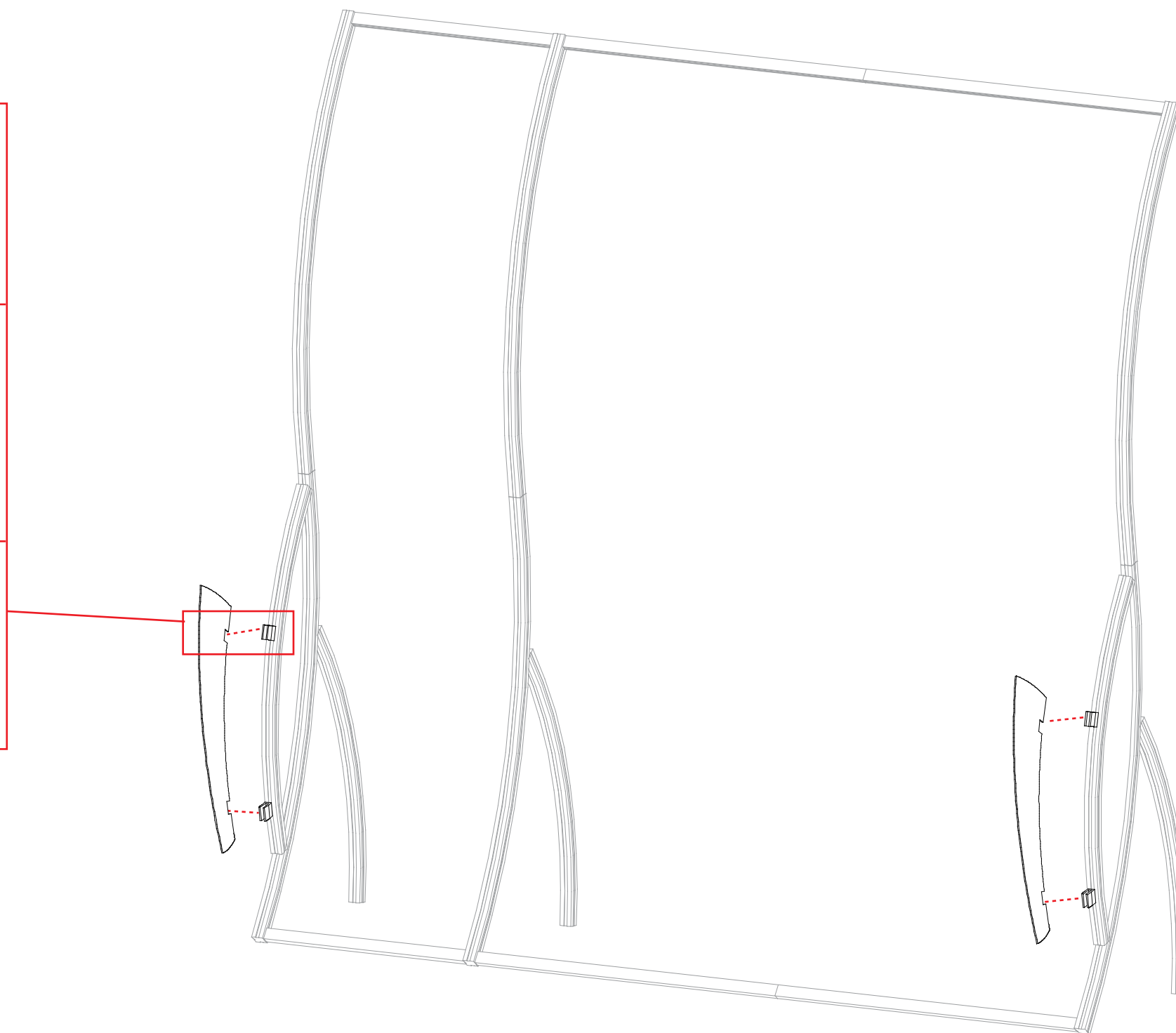

WHEN DISASSEMBLING TIGHTEN ALL KNOBS TO PREVENT LOSS DURING SHIPPING

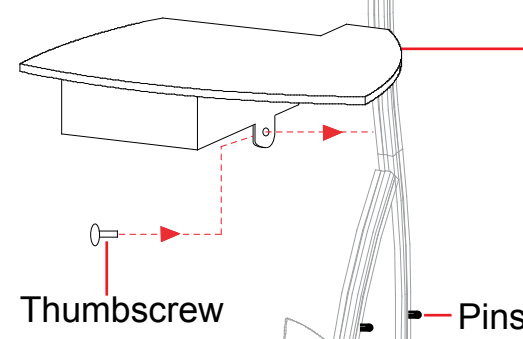
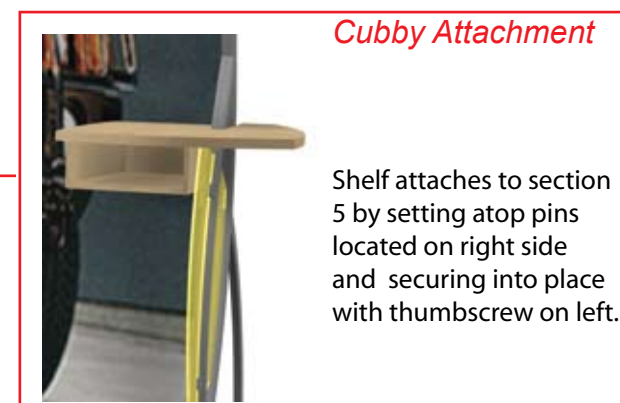
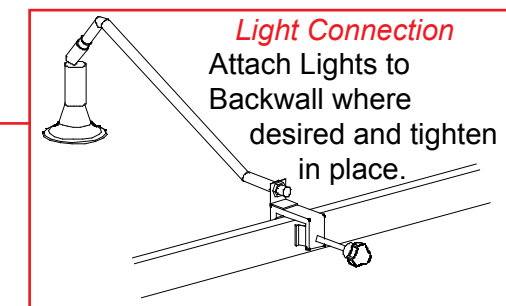
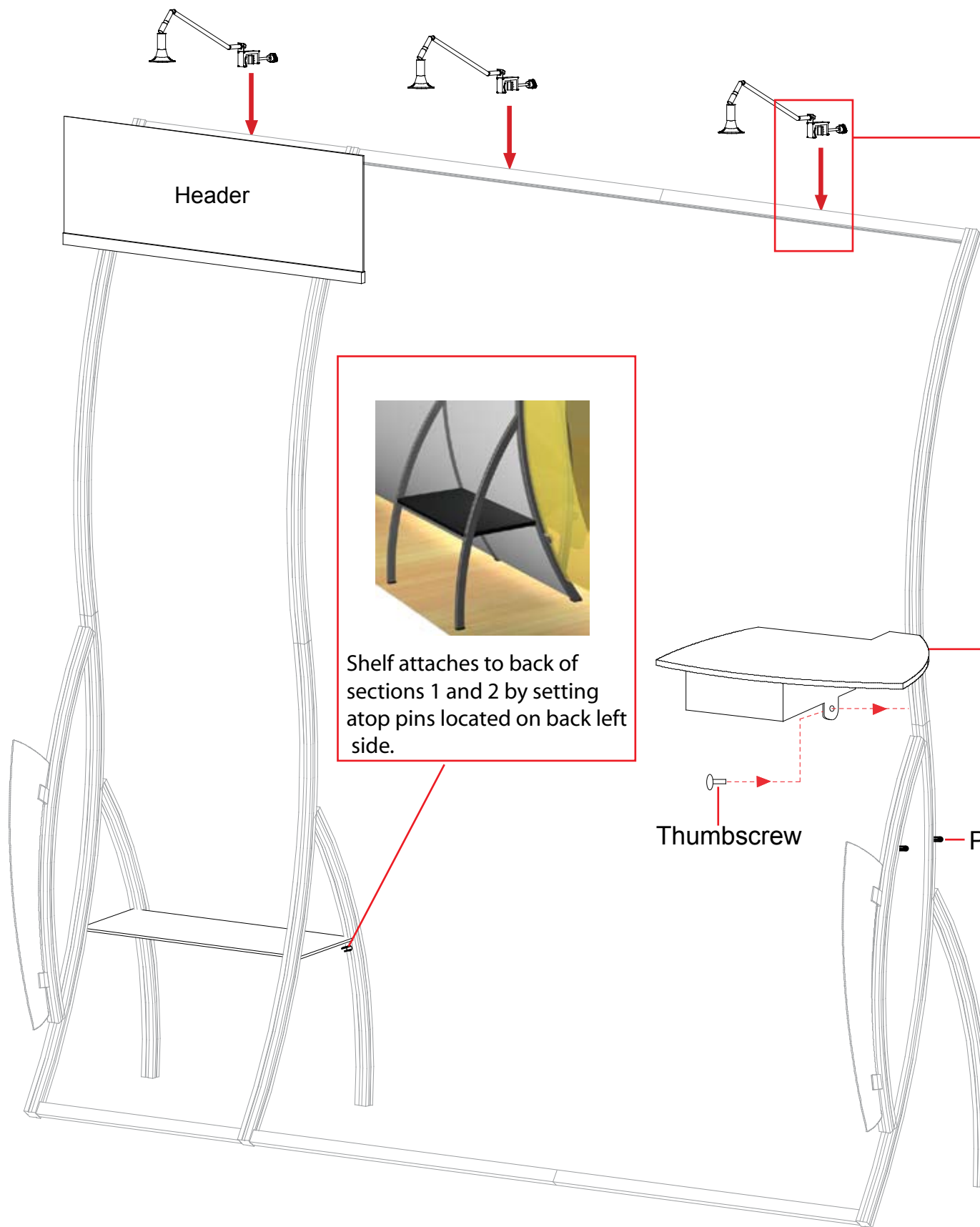
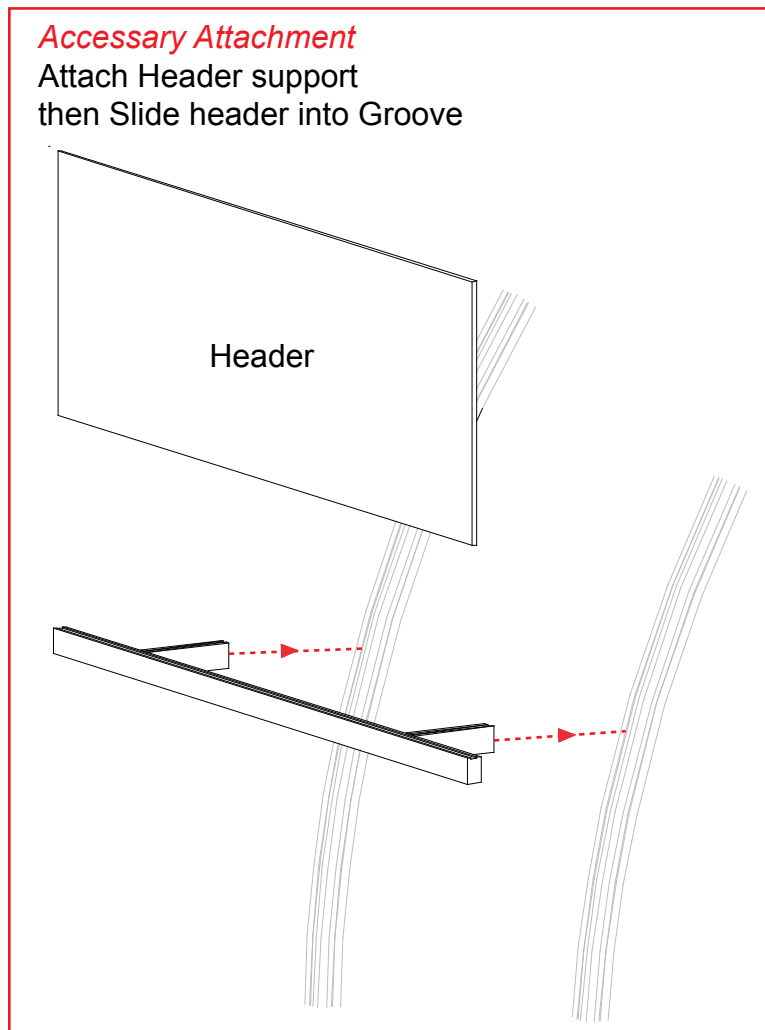
866.652.2100



WHEN DISASSEMBLING TIGHTEN ALL KNOBS TO PREVENT LOSS DURING SHIPPING

Case #1 - Backwall Components

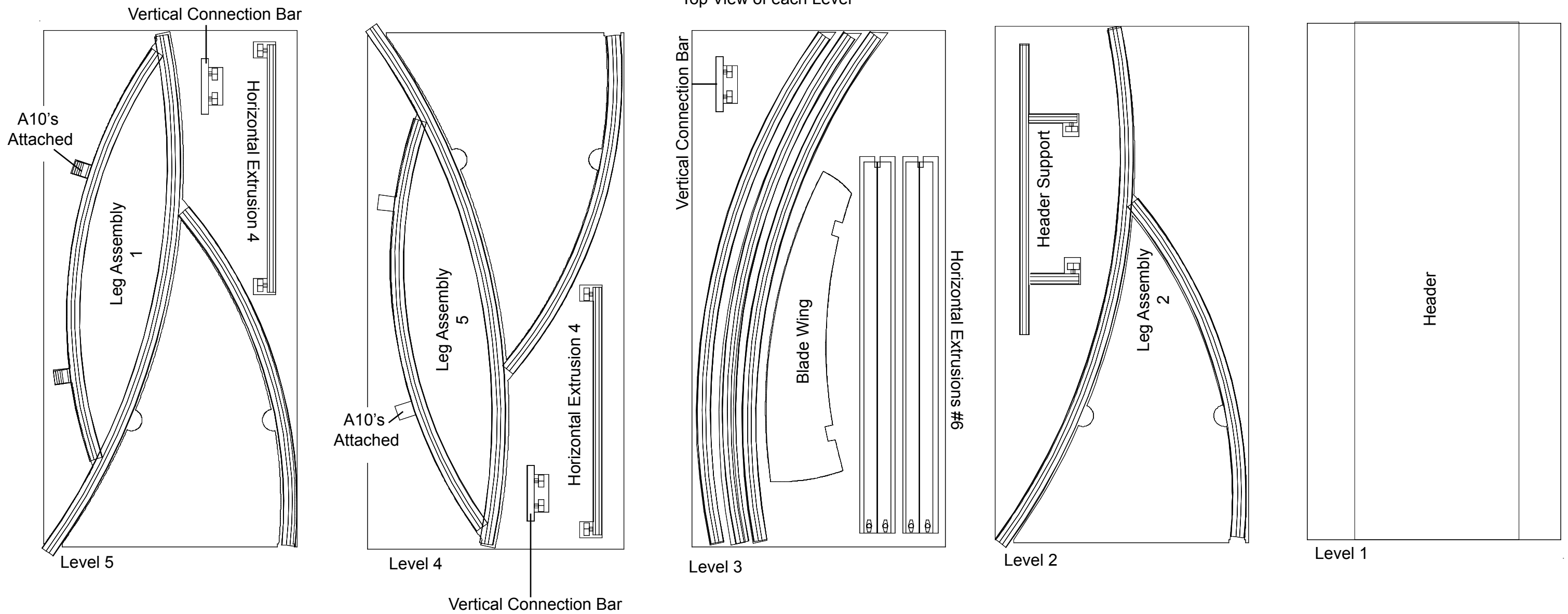

WHEN DISASSEMBLING TIGHTEN ALL KNOBS TO PREVENT LOSS DURING SHIPPING

Case #2 - Backwall Components

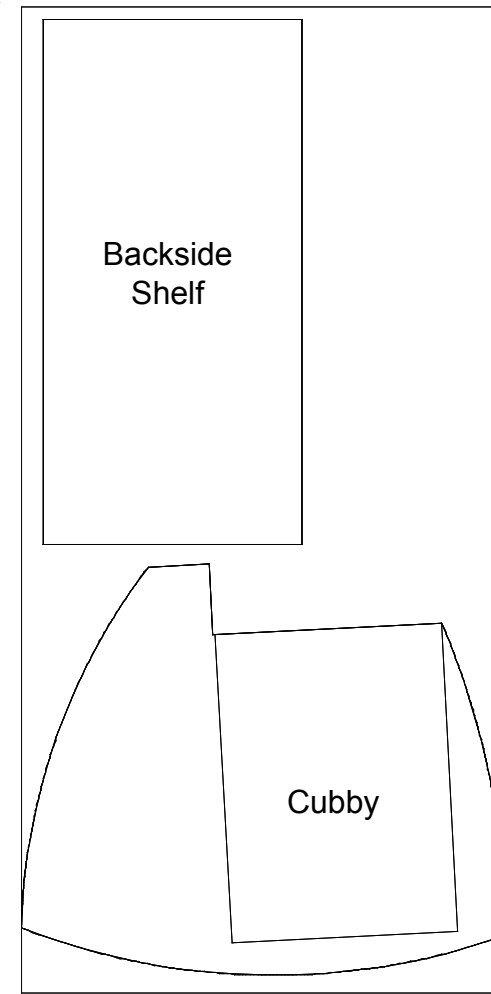

Level 1

- Additional Items:*
- Setup Hardware
 - Graphic
 - (3) Lights

WHEN DISASSEMBLING TIGHTEN ALL KNOBS TO PREVENT LOSS DURING SHIPPING