

euro It | HYBRIDS

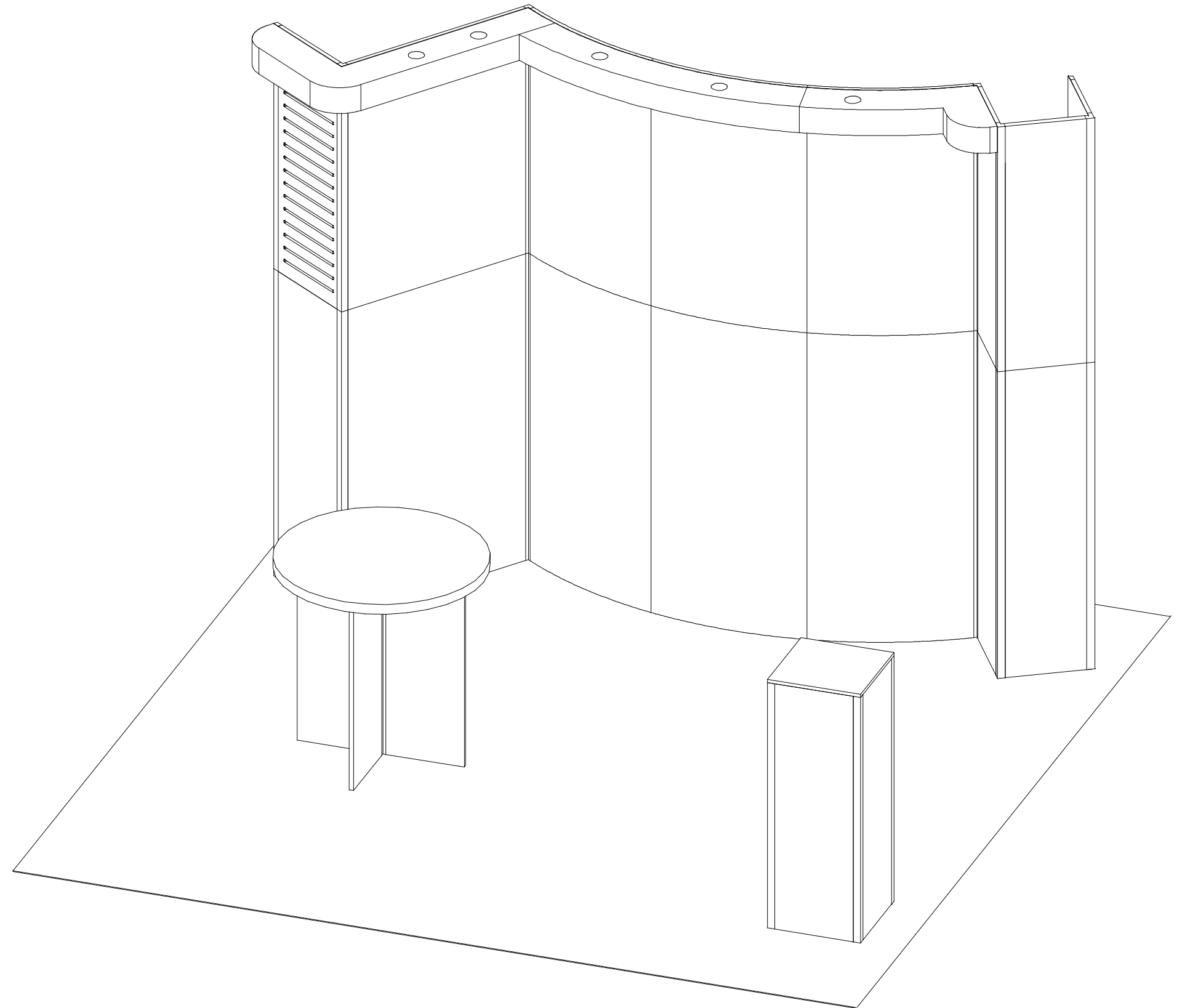
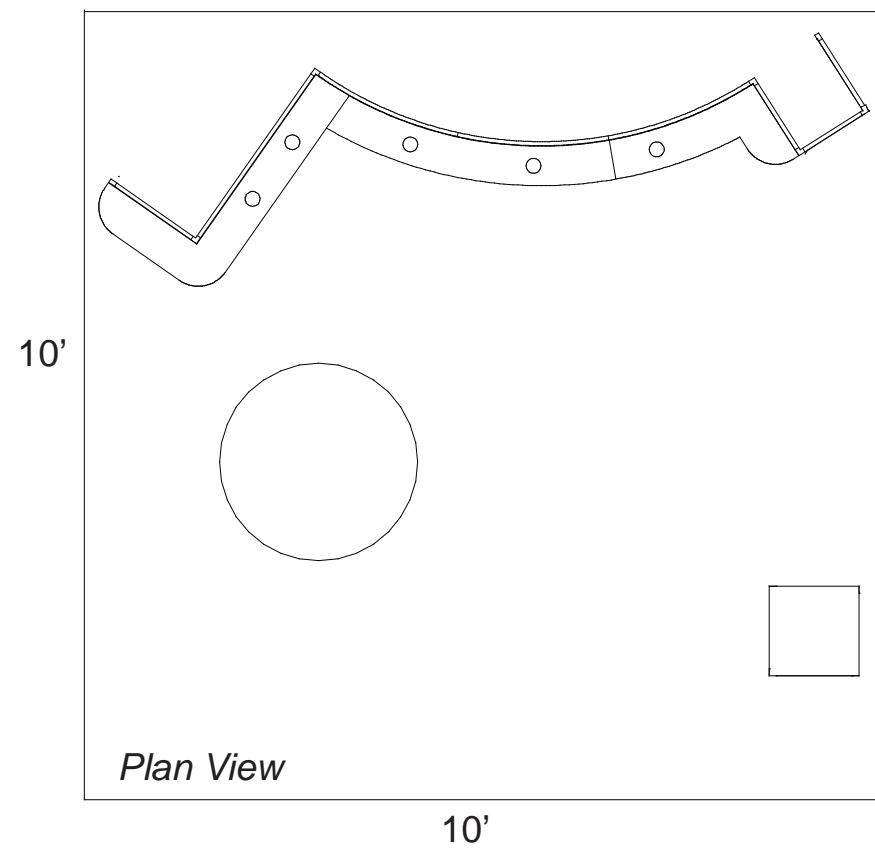

euro lt | HYBRIDS

Euro LT Hybrids General Setup Instructions

Using Your Setup Instructions

The Euro LT Hybrids Setup Instructions are created specifically for your configuration. They are laid out sequentially in levels, including exploded views, and a logical series of detailed steps to assemble the main structure and components. We encourage you to study the instructions **before** attempting to assemble your exhibit.

Cleaning and Packing Your Display

- 1) When cleaning laminate countertops or panels use mild cleansers and a soft material such as cotton.
- 2) Keep all display components away from extreme heat and long exposure to sunlight to avoid warping and fading.
- 3) Retain all packing material. It will make re-packing much easier and will reduce the likelihood of shipping damage.

Level 1 = Blue
 Level 2 = Red
 Level 3 = Green
 Level 4 = Black

Color Code

The top clip is color coded to distinguish the level. The color coded clip also contains the numbered label

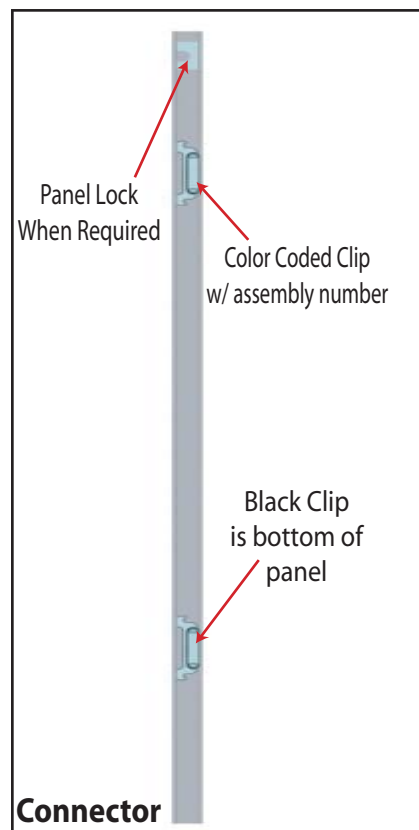

Each component has 2 clips, the lower clip is ALWAYS black..

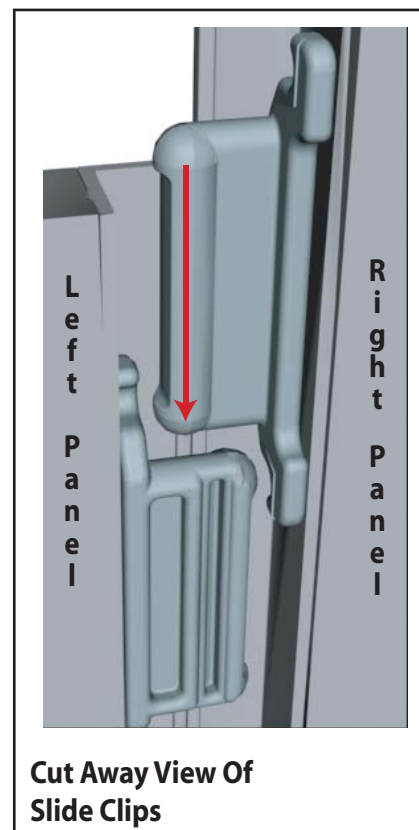

Components connect together by aligning them and sliding downward connecting clips together.

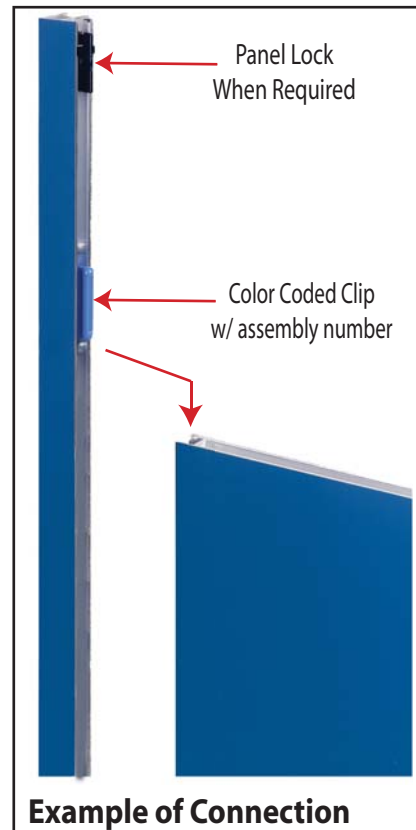

Configurations are assembled from left to right, usually starting with #1 and following the numbered sequence.

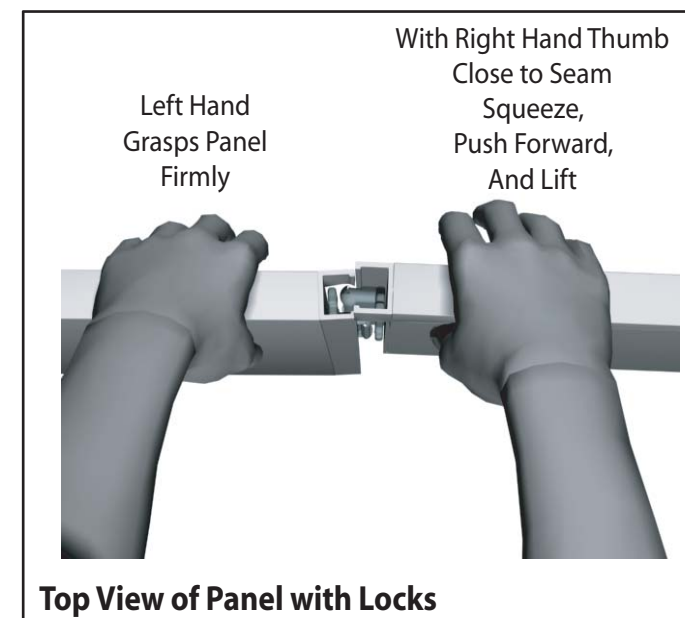

The first level of components contains panel locks that are located at the top of the panel for extra stability and a seamless connection. When disassembling panels, twist top connection slightly and lift right panel upward.



866.652.2100

Item Number	Description
1	47.5" h End Cap
2	14.125" w x 47.5" h Flat Panel
3	47.5" h 90° Connector
4	30" w x 47.5" h Flat Panel w/ Internal Rib for Lit. Attachment
5	47.5" h 90° Connector
6	57.5" r x 47.5" h Curved Panel
7	57.5" r x 47.5" h Curved Panel
8	57.5" r x 47.5" h Curved Panel
9	47.5" h 90° Connector
24	11.5" w x 47.5" h Flat Panel
25	47.5" h 90° Connector
26	11.5" w x 47.5" h Flat Panel
27	47.5" h 90° Connector
28	11.5" w x 47.5" h Flat Panel
29	47.5" h End Cap

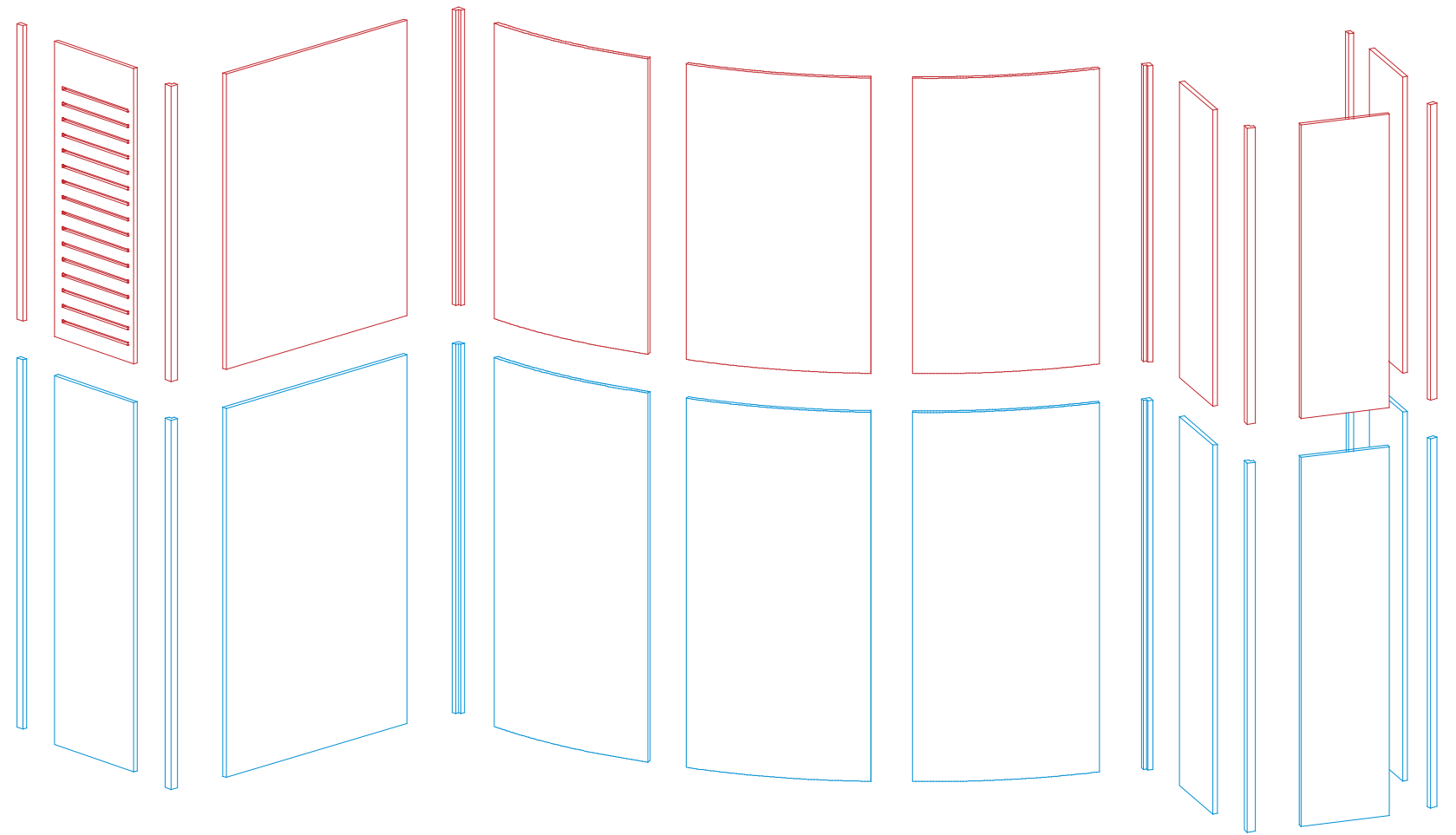

Steps:

- 1) Assemble by starting at panel #1* and continue in numerical order.

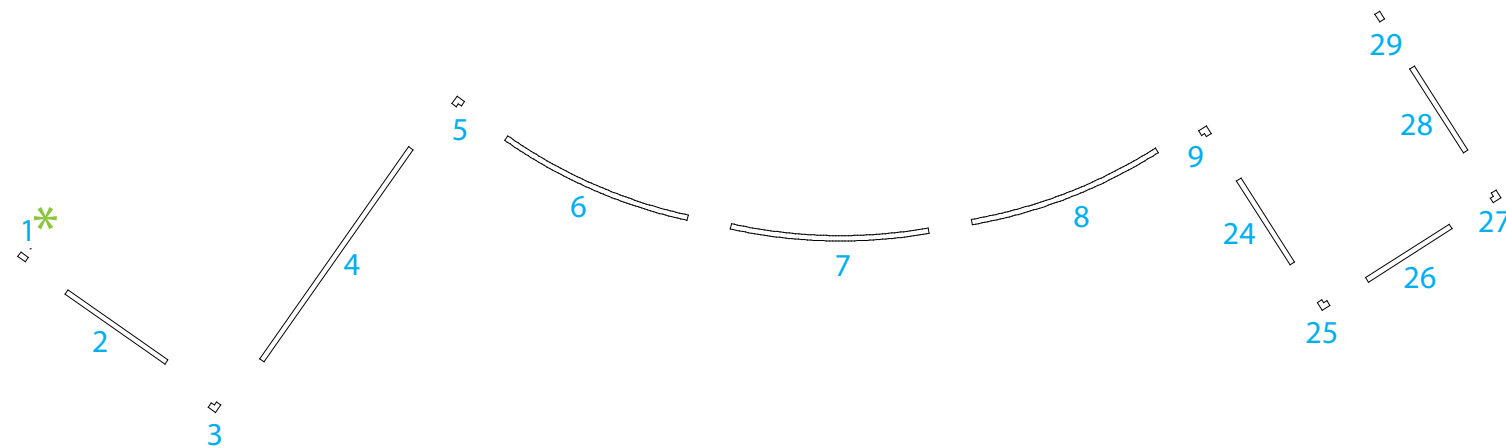

866.652.2100

Item Number	Description
1	38" h End Cap
2	14.125" w x 38" h Slatwall Panel
3	38" h 90° Connector
4	30" w x 38" h Flat Panel w/ Wood Core
5	38" h 90° Connector
6	57.5" r x 38" h Curved Panel
7	57.5" r x 38" h Curved Panel
8	57.5" r x 38" h Curved Panel
24	11.5" w x 38" h Flat Panel
25	38" h 90° Connector
26	11.5" w x 38" h Flat Panel
27	38" h 90° Connector
28	11.5" w x 38" h Flat Panel
29	38" h End Cap
30	38" h 90° Connector

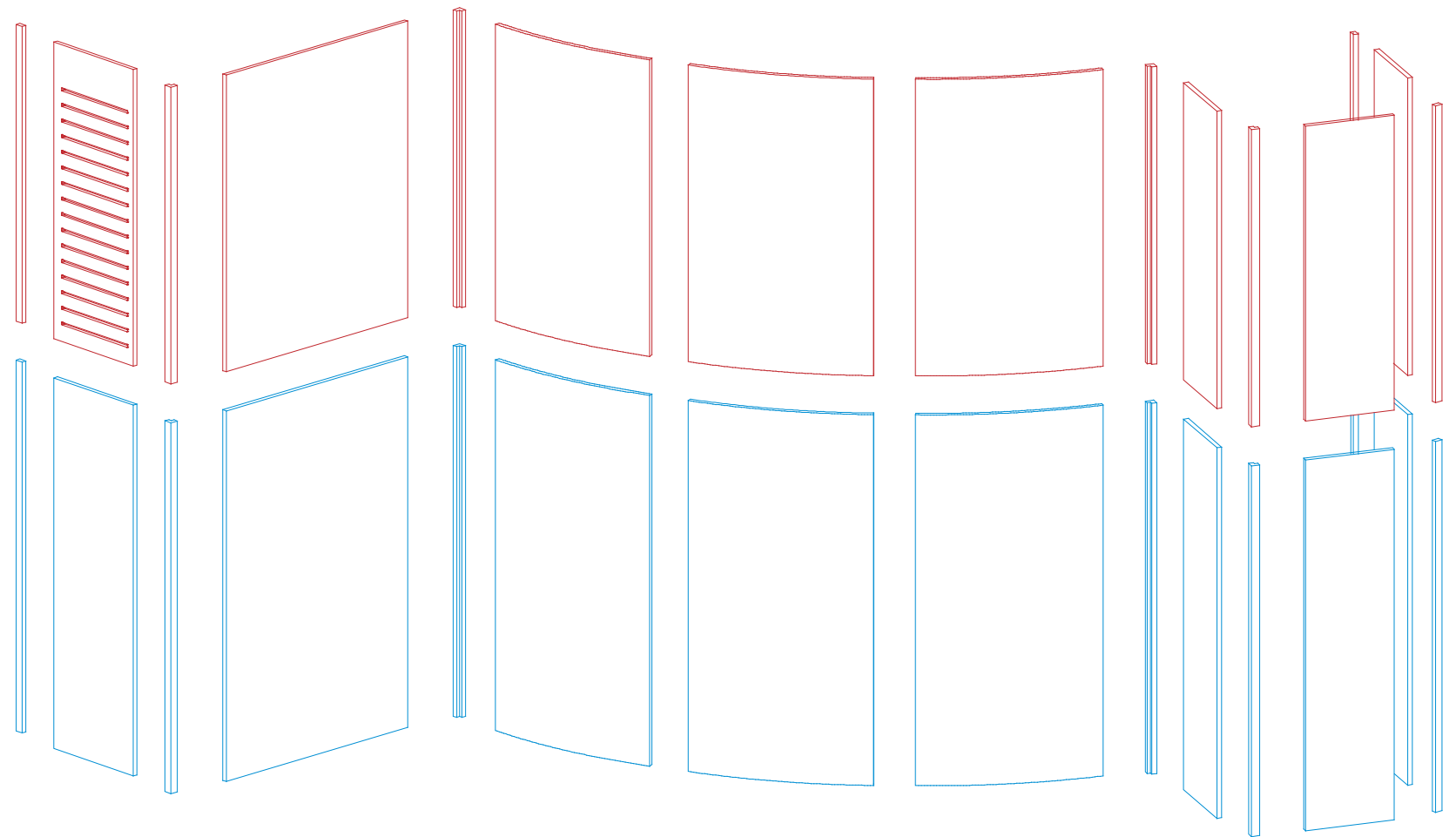

Steps:
 1) Assemble by starting at panel #1* and continue in numerical order.

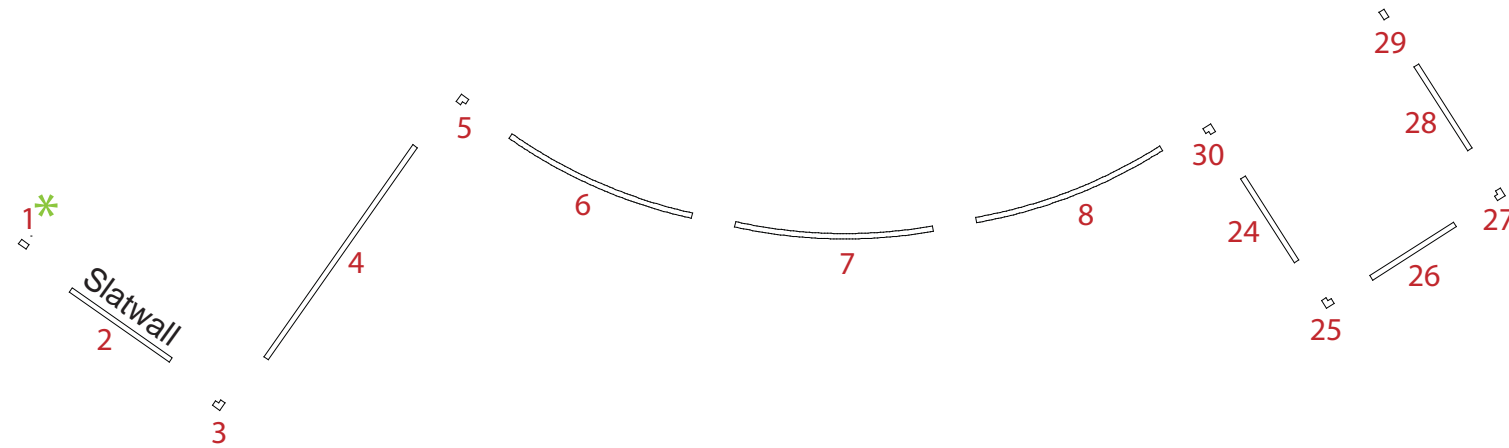

866.652.2100

Steps:

- 1) Hook custom blade headers to top of assembled backwall.
- 2) Attach thumbscrew to back of assembled backwall as indicated for stability.
- 3) Attach literature racks to panel. Refer to detail.

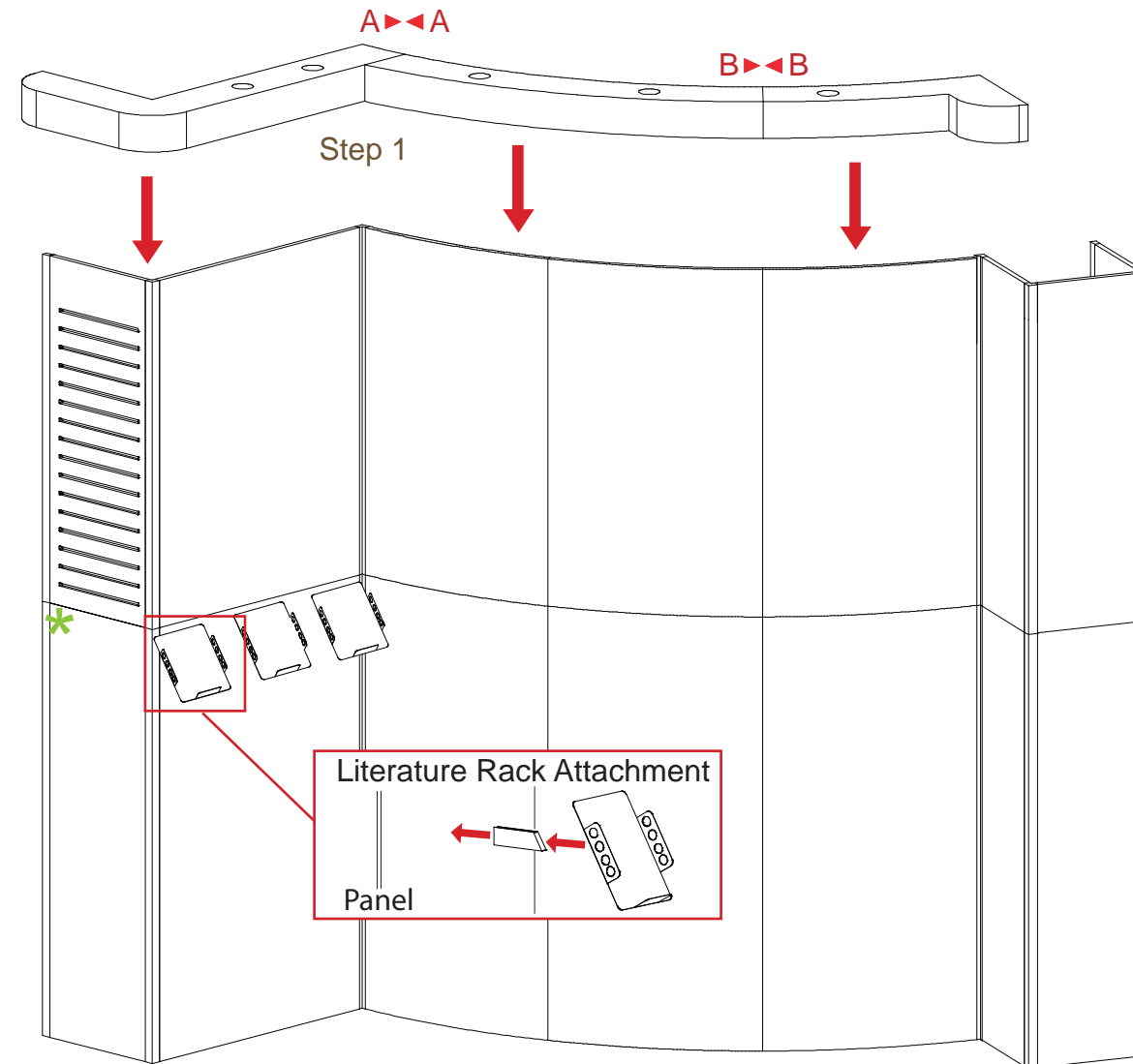

* = Indicates thumbscrew attachment

Item Number	Description
40	11.5" w x 38" h Flat Panel
41	38" h 90° Connector
42	11.5" w x 38" h Flat Panel
43	38" h 90° Connector
44	11.5" w x 38" h Flat Panel w/ Door
45	38" h 90° Connector
46	11.5" w x 38" h Flat Panel
47	38" h 90° Connector

Steps:

- 1) Assemble pedestal by starting at panel #40 and continue in numerical order.
- 2) Velcro shelf supports to inside of assembled pedestal, then set internal shelf atop support.
- 3) Set counter atop assembled base.

866.652.2100

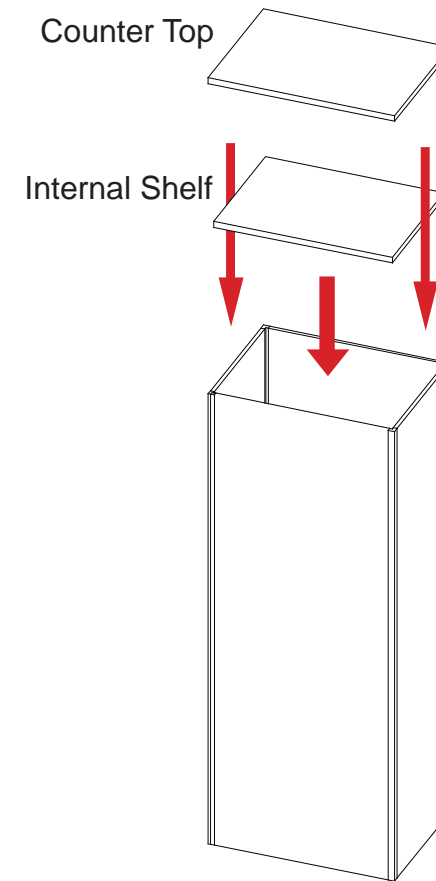
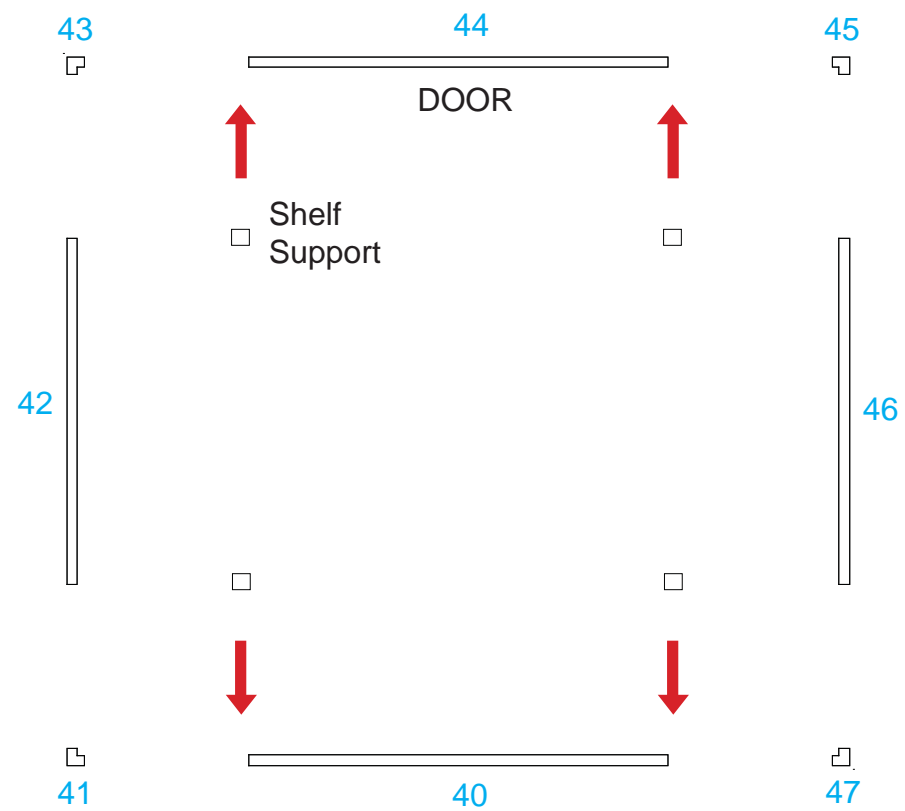
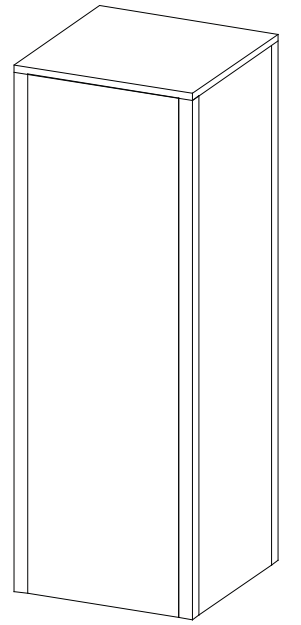

866.652.2100

Item Number	Description
48	30" h 4-way Connector
49	11.5" w x 30" h Flat Panel
50	11.5" w x 30" h Flat Panel
51	11.5" w x 30" h Flat Panel
52	11.5" w x 30" h Flat Panel

Steps:

- 1) Assemble base by starting at connector #48 and continue in numerical order.
- 2) Set counter atop assembled base.

