

10'

10'

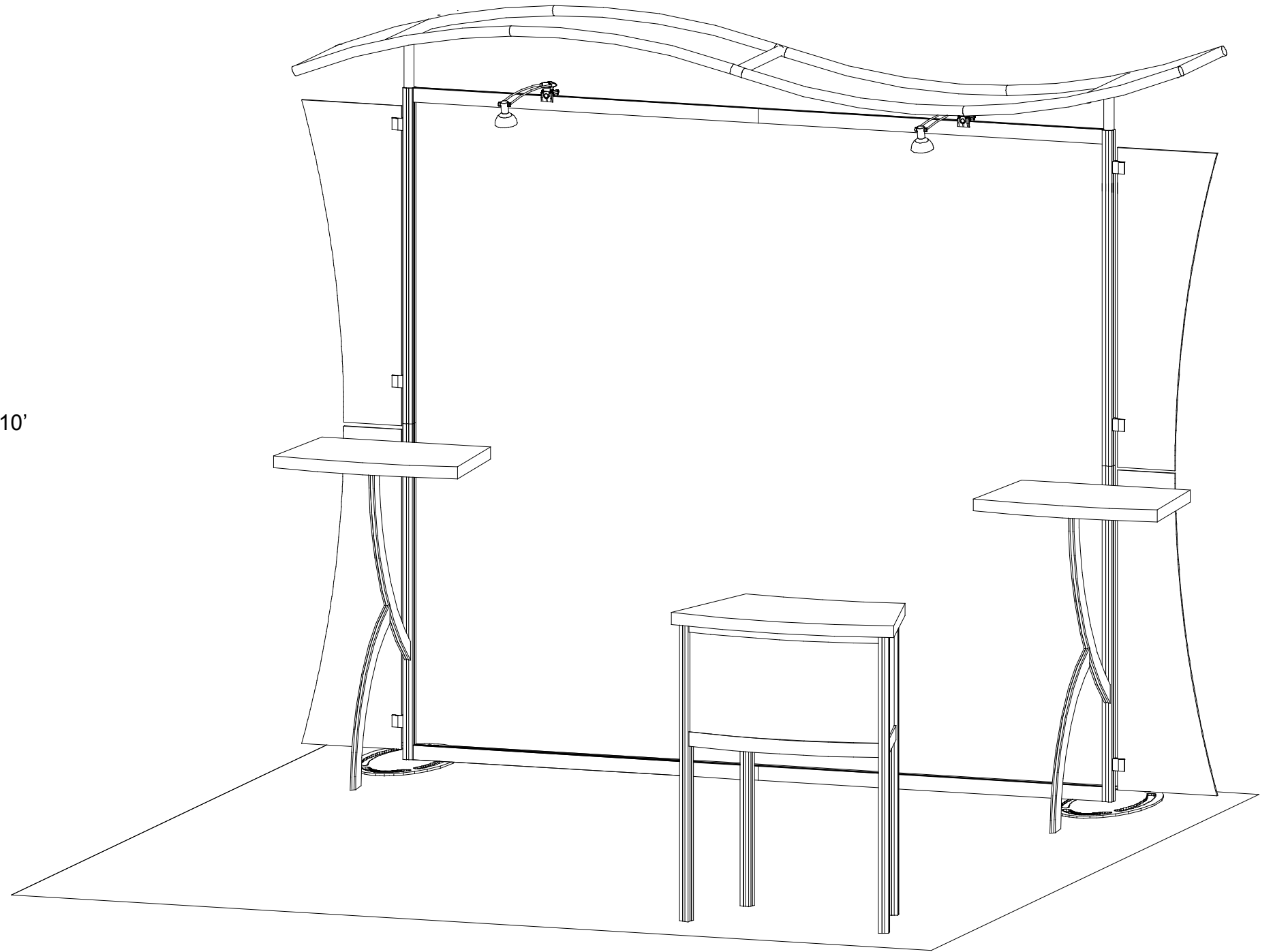

WHEN DISASSEMBLING ALUMINUM EXTRUSION, TIGHTEN ALL SETSCREWS AND LOCKS TO PREVENT LOSS DURING SHIPPING

visionary™ IDESIGNS

Using Your Setup Instructions

The Visionary Designs Setup Instructions are created specifically for your configuration. They are laid out sequentially, including an exploded view of the entire display, and then a logical series of detailed steps to assemble the main structure and components. We encourage you to study the instructions **before** attempting to assemble your exhibit.

Each page reminds you to tighten the setscrews after disassembling your exhibit to prevent loss of the locks and setscrews (see below in RED). This is **VERY IMPORTANT**.

Cleaning and Packing Your Display

- 1) Use care when cleaning aluminum extrusion or acrylic inserts. Use only non-abrasive cleaners.
- 2) When cleaning laminate inserts or countertops, use mild cleansers and a soft material such as cotton.
- 3) Keep all display components away from extreme heat and long exposure to sunlight to avoid warping and fading.
- 4) Retain all packing material. It will make re-packing much easier and will reduce the likelihood of shipping damage.



The Tool

Most Visionary Designs exhibits can be assembled with the supplied Hex Key Tool. Occasionally, a flat head screwdriver may be required.



Detail A

Typical Connection



Typical Connection (cont'd)

Most horizontal extrusion connections have a patented expandable lock. This lock inserts into the groove of an opposing extrusion. Tightening the lock with the Hex Key Tool expands the lock and creates a strong positive connection.

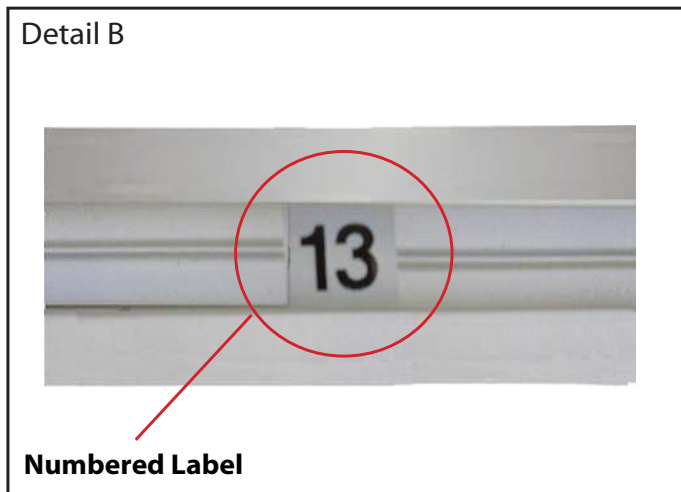

Detail B

Numbered Label

Each extrusion contains a numbered label which corresponds with setup instructions. The label is located within a groove of the extrusion (when possible). With Visionary Designs the labels contain Black numbers unless otherwise specified.



Detail C

Horizontal Inline Connection (remove only one setscrew)

Remove only (1) setscrew when disassembling. Replace setscrew in extrusion after assembling it. Before packing, replace setscrew in extrusion to avoid losing it.



Detail D

Base Plate Connection

Attach base plate to round or square vertical extrusion using the bolt provided. Be careful not to strip the threads.

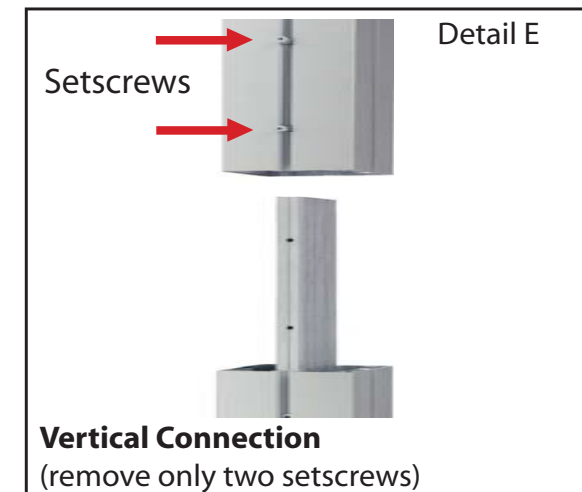

Detail E

Vertical Connection

(remove only two setscrews)

When vertical extrusions are packed in portable cases rather than crates or tubs, they must be broken down into smaller sections which then require assembly.

Remove only (2) setscrews when disassembling. Replace setscrews in extrusion after assembling it. Before packing, replace setscrews in extrusion to avoid losing them.

WHEN DISASSEMBLING ALUMINUM EXTRUSION, TIGHTEN ALL SETSCREWS AND LOCKS TO PREVENT LOSS DURING SHIPPING

866.652.2100

Item	Qty.	Description
1	2	Base Plate
2	1	42" h Lower Square Vertical Extrusion w/ A10 Clamps Attached
3	1	42" h Upper Square Vertical Extrusion w/ A10 Clamps Attached
2a	1	42" h Lower Square Vertical Extrusion w/ A10 Clamps Attached
3a	1	42" h Upper Square Vertical Extrusion w/ A10 Clamps Attached
4a/4b	1/1	45" w Horizontal Extrusion
5a/5b	1/1	45" w Horizontal Extrusion

Steps:

- 1) Attach vertical extrusions [2 and 2a] to base plates [1].
- 2) Attach upper vertical extrusions [3 and 3a] to lower extrusions [2 and 2a] using connection bar [b].
- 3) Connect horizontal extrusions [4a to 4b and 5a to 5b] together using connection bar [a].
- 4) Attach horizontal assemblies [4a/4b and 5a/5b] between vertical assemblies as shown.
- 5) Apply graphic to back of assembled backwall.
- 6) Attach light to top of assembled backwall.

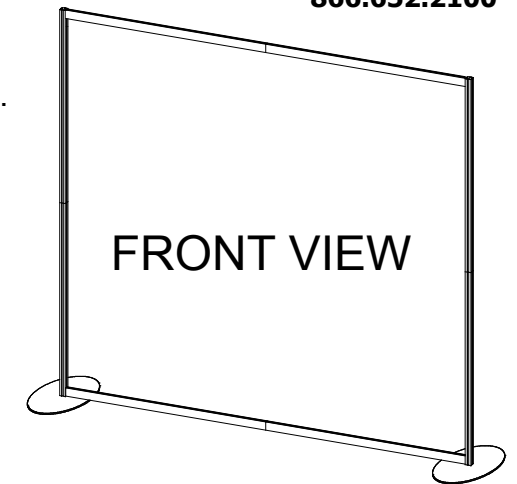

STAR indicates location of knobs on BACKSIDE of unit.

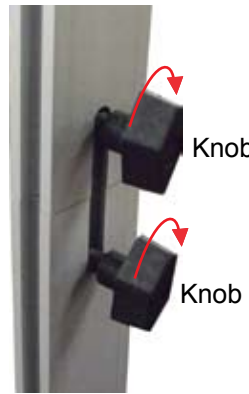

Knob

Knob

Turn Knob Clockwise to Tighten Lock

Do not over tighten Knobs.

Light Connection

Attach lights to backwall where desired and tighten in place.

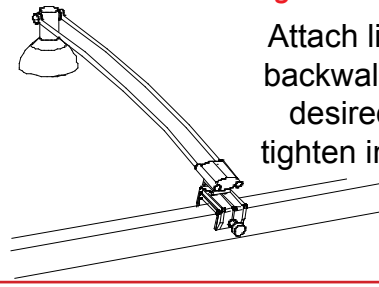

Horizontal Placement

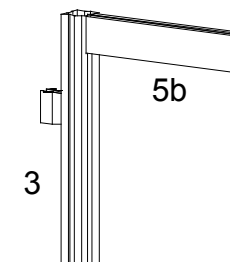

Set upper horizontal bars [5a/5b] to be flush with top of vertical extrusions.

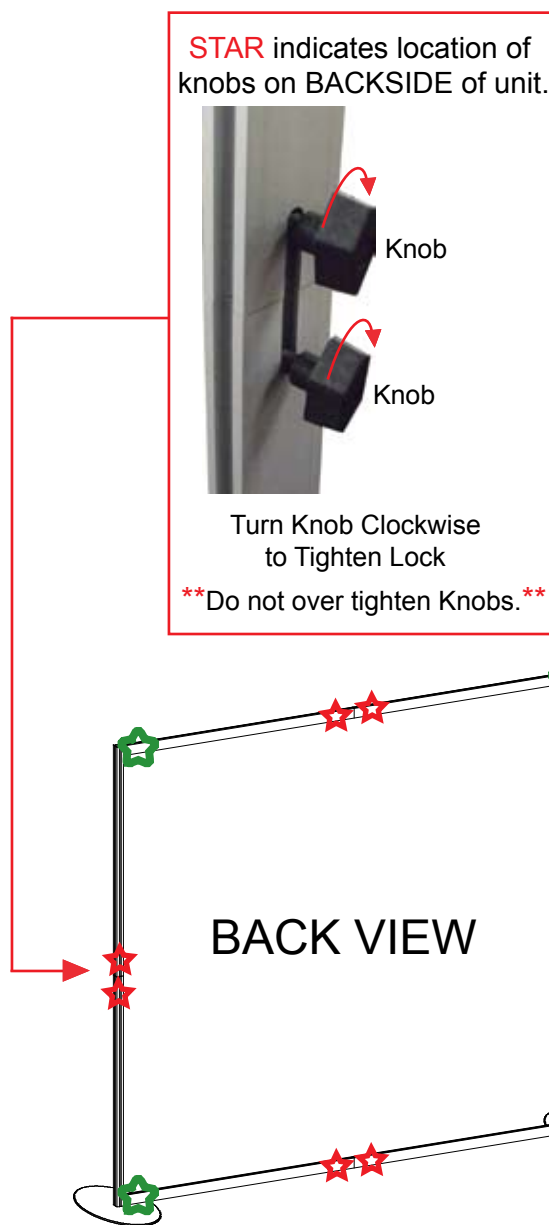

BACK VIEW

GREEN STAR indicates location of connection lock with knob.



Velcro at center of bar

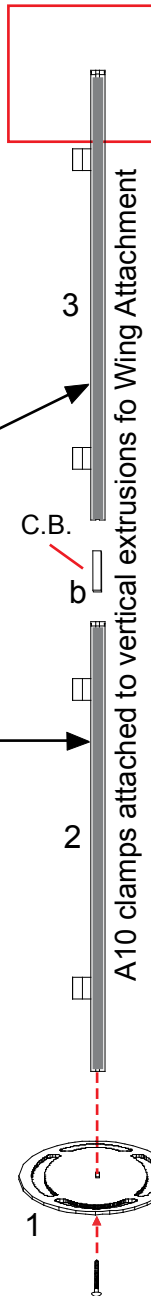

A10 clamps attached to vertical extrusions for Wing Attachment

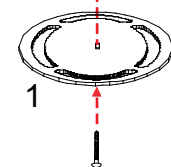

1

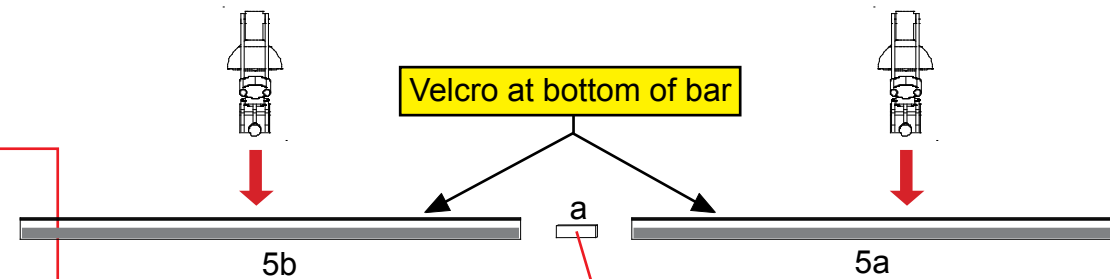

Velcro at bottom of bar

5b

Connection Bar

5a

BACK VIEW

Graphic Attachment
Apply graphic to back of assembled backwall.

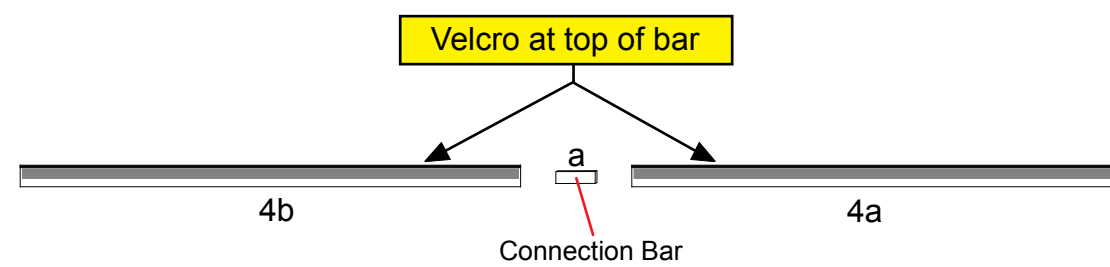

Velcro at top of bar

4b

Connection Bar

4a

Note: Slide connection bar between extrusions and tighten knobs to secure.

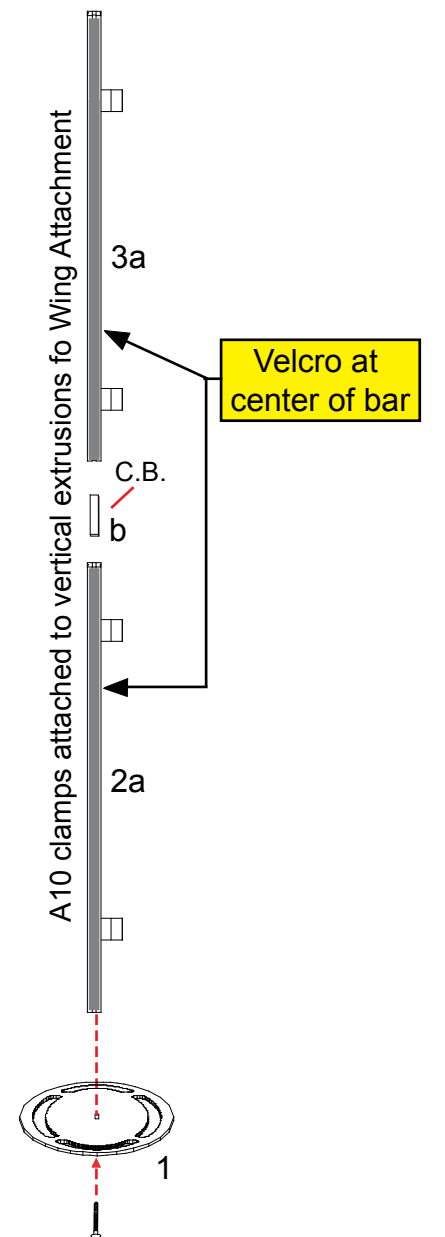

A10 clamps attached to vertical extrusions for Wing Attachment

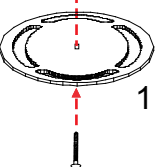

1

Velcro at center of bar

WHEN DISASSEMBLING ALUMINUM EXTRUSION, TIGHTEN ALL SETSCREWS AND LOCKS TO PREVENT LOSS DURING SHIPPING

866.652.2100

*** Monitor Mount Attachment**

Attach monitor mount back plate to connectors using screws provided.

Item	Qty.	Description
10	2	30.2" Curved Extrusion
10a	2	Support Leg
11	2	12.184"w Horizontal Extrusion
11a	2	Flange Plate

Steps:

- 1) Connect support legs [10a] to extrusion assemblies [10/11].
- 2) attach assembled counter support [10/11] to vertical where indicated.
- 3) Attach flange plate [11a] to top of curved extrusion [10] as shown.
- 4) Attach counter atop support, see counter top attachment detail.
- 5) Repeat steps for additional counter.
- 6) Attach wings to clamps as shown.

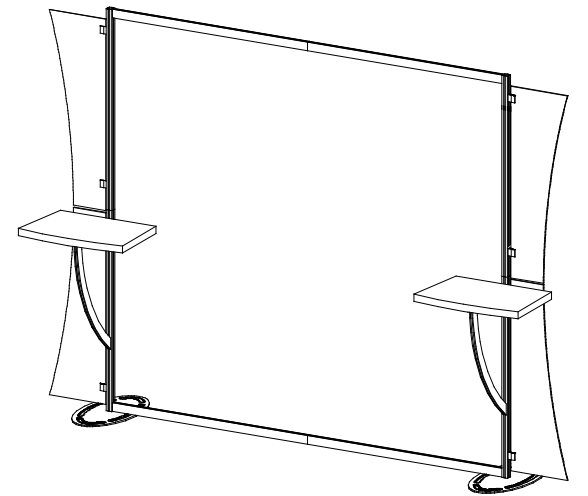

Wing Attachment

Slide A10 Clamp into groove of square extrusion.

When desired location is found, tighten set screw to secure.

Tighten black plastic Knob to secure Wing in place.

**Note: A10 clamps must stay attached with verticals*

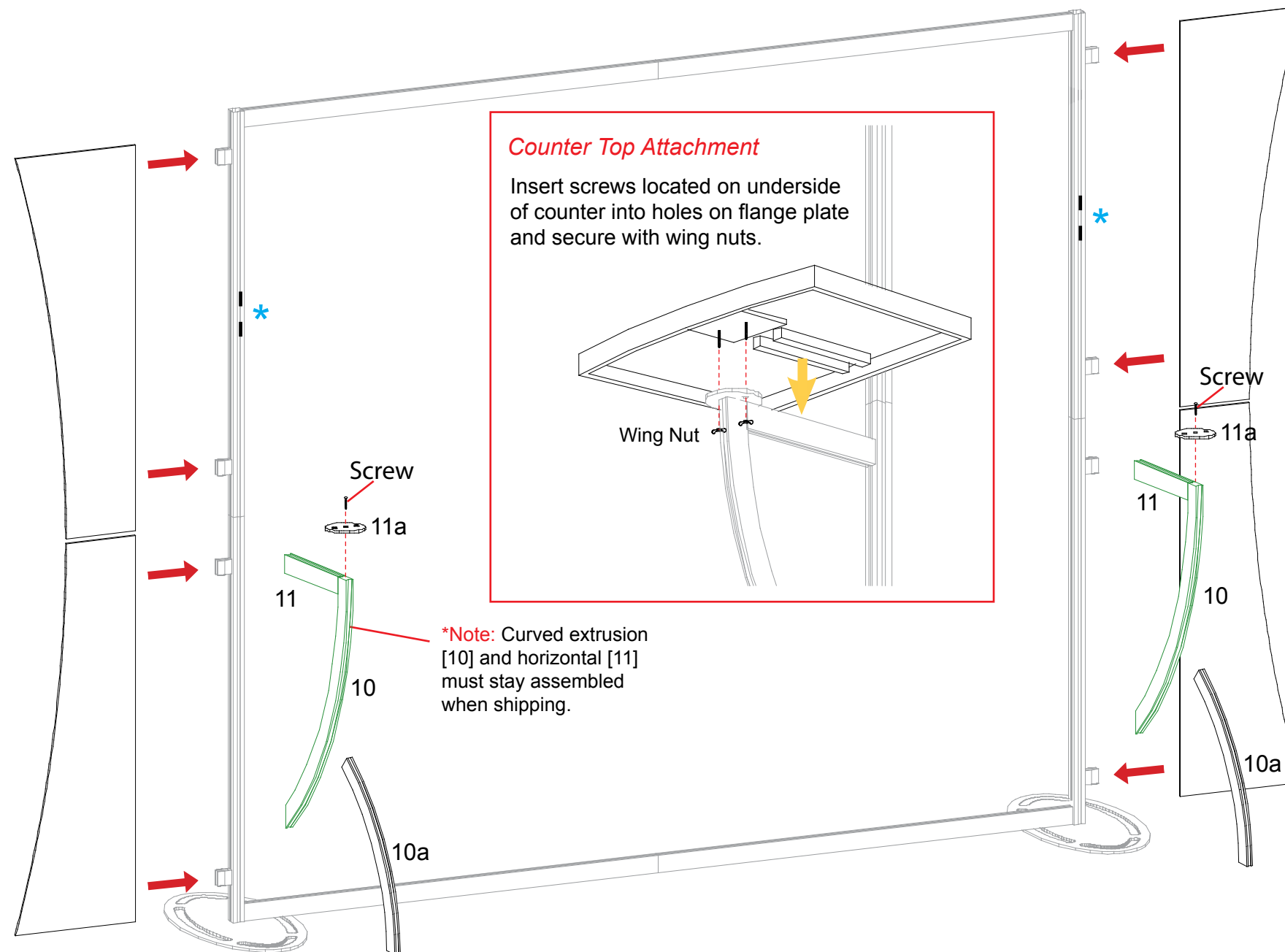

WHEN DISASSEMBLING ALUMINUM EXTRUSION, TIGHTEN ALL SETSCREWS AND LOCKS TO PREVENT LOSS DURING SHIPPING



Steps:

- 1) Connect canopy pieces together as shown.
- 2) Apply pillow case graphic to assembled canopy.

Using Your Setup Instructions

The Aero Overhead Sign Setup Instructions are created specifically for your configuration. They include an exploded view of the frame which is sequentially numbered. We encourage you to study the instructions before attempting to assemble your exhibit.

Connections are kept very simple: no tools. Everything assembles with push-button connectors and pre-connected horizontal sections.

Cleaning and Packing Your Display

- 1) Use care when cleaning aluminum extrusion or acrylic inserts. Use only non-abrasive cleaners.
- 2) Retain all packing material. It will make re-packing much easier and will reduce the likelihood of shipping damage.

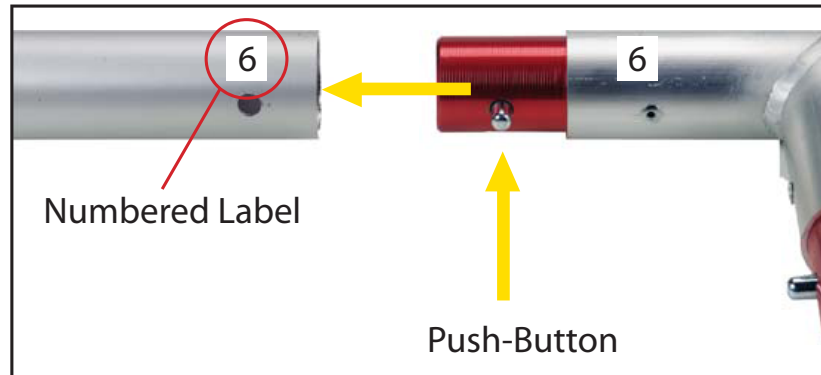
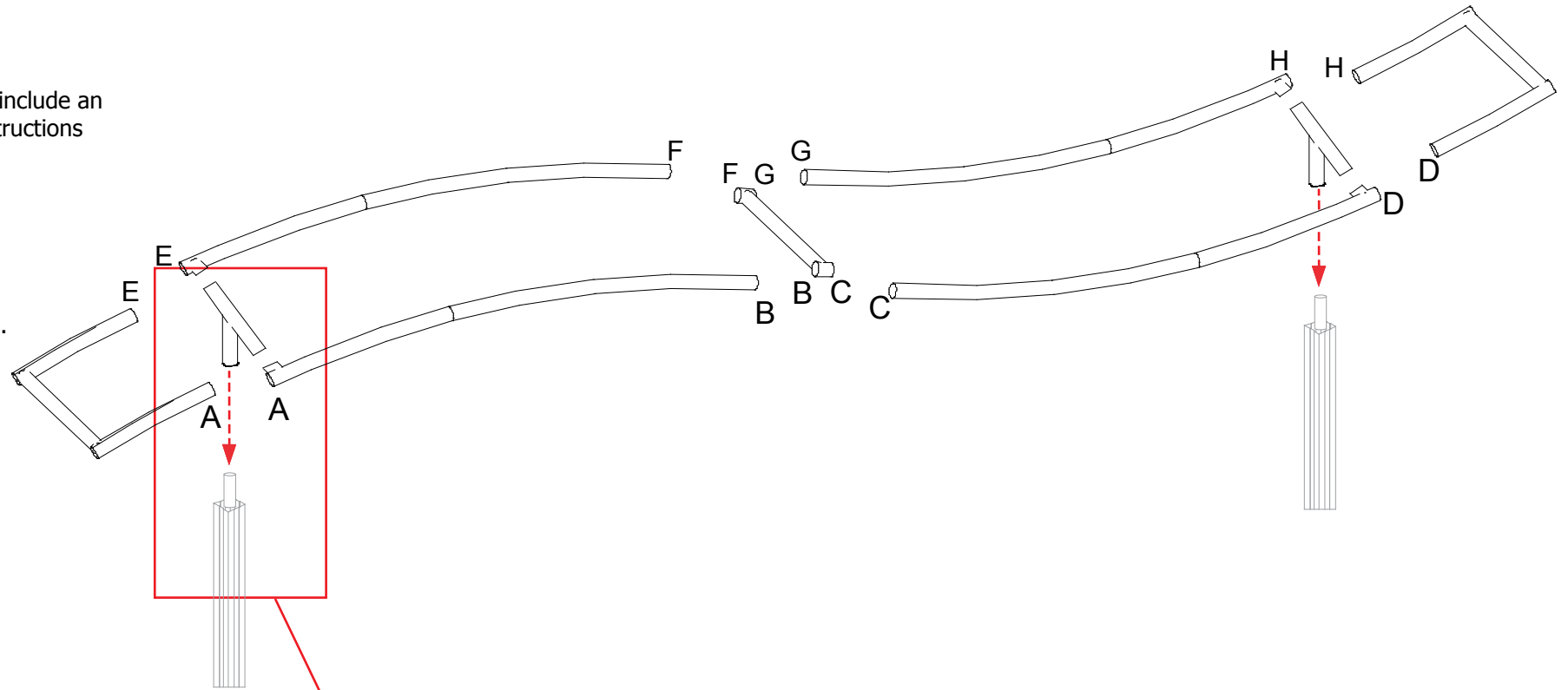

Connections are made by holding the button down and sliding the red tube into opposing tube until the connection is made. To disassemble push button and pull or twist extrusions apart.

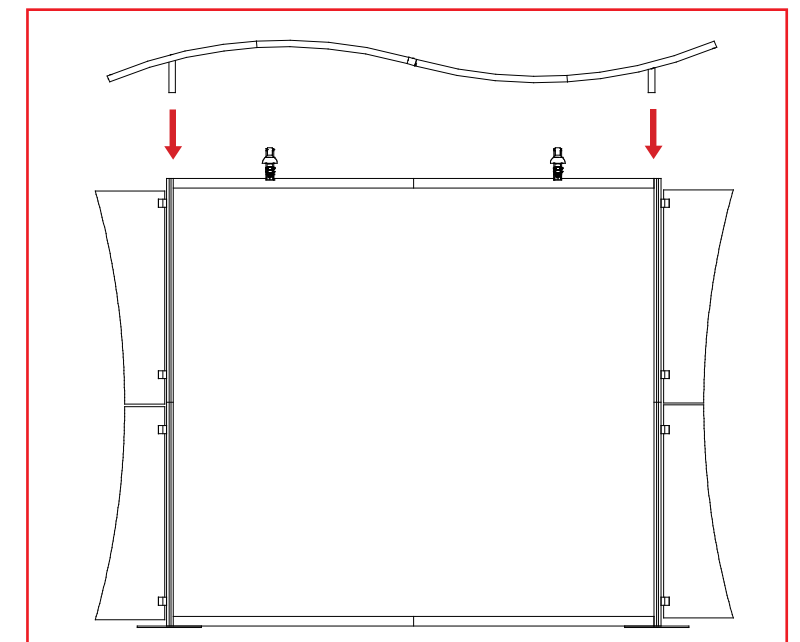
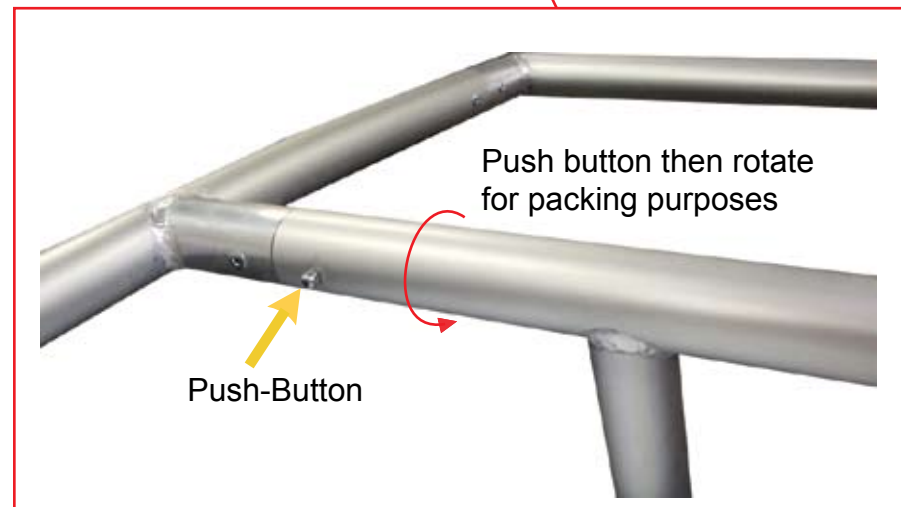
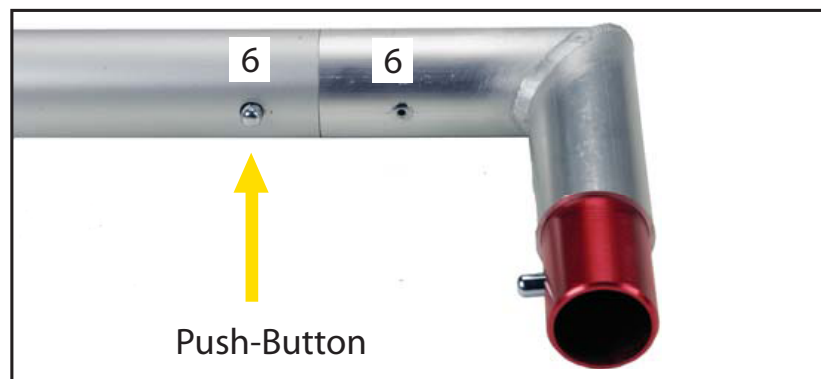

WHEN DISASSEMBLING ALUMINUM EXTRUSION, TIGHTEN ALL SETSCREWS AND LOCKS TO PREVENT LOSS DURING SHIPPING

866.652.2100

Part Number	Qty	Description
12	4	38" h Vertical Extrusion
13/13a	2/2	12" w Horizontal Extrusion
14	2	25" w Horizontal Extrusion

Steps

- 1) Attach horizontal extrusions [13 and 13a] between vertical extrusions [12], placing inserts between horizontals.
- 2) Attach curved horizontal extrusions [14] between vertical extrusions [12], placing insert between curved horizontals.

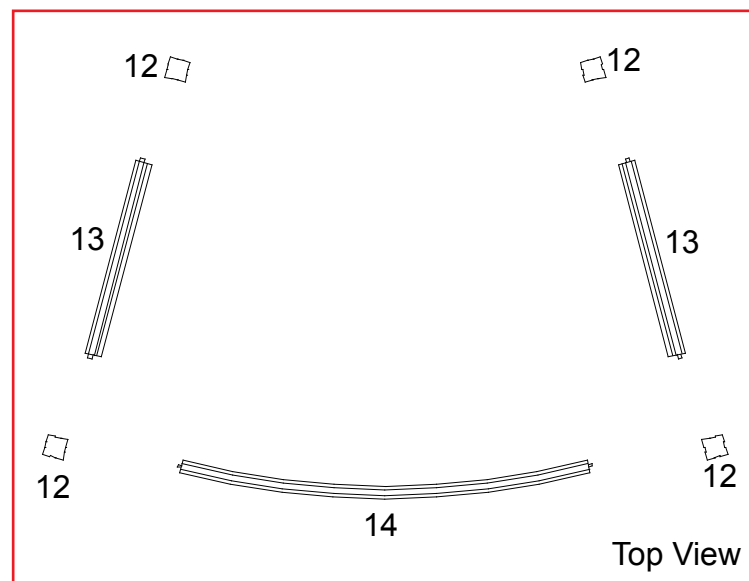

Steps (Cont'd):

- 3) Place shelf atop lip of extrusions.
- 4) Set counter top atop assembled base.

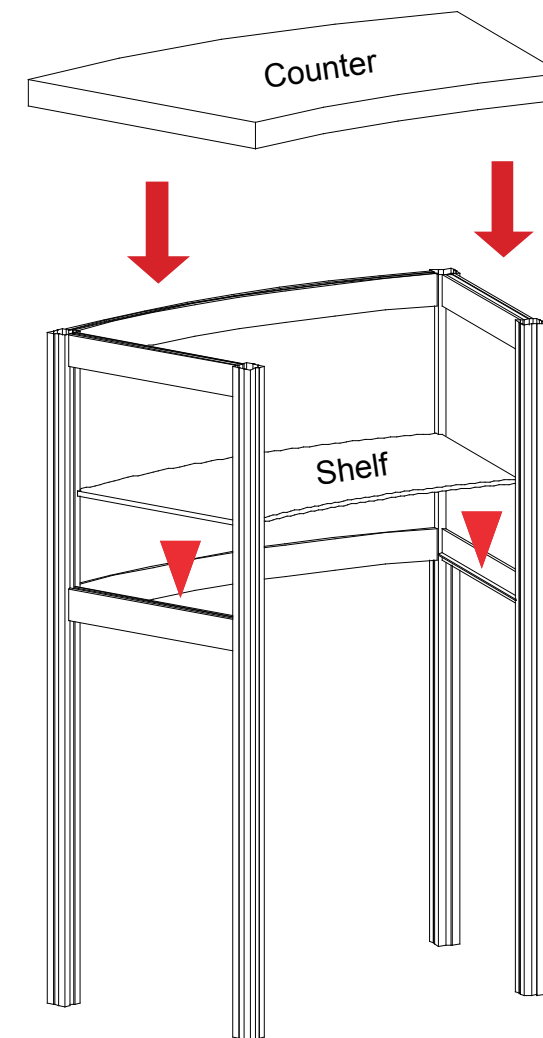
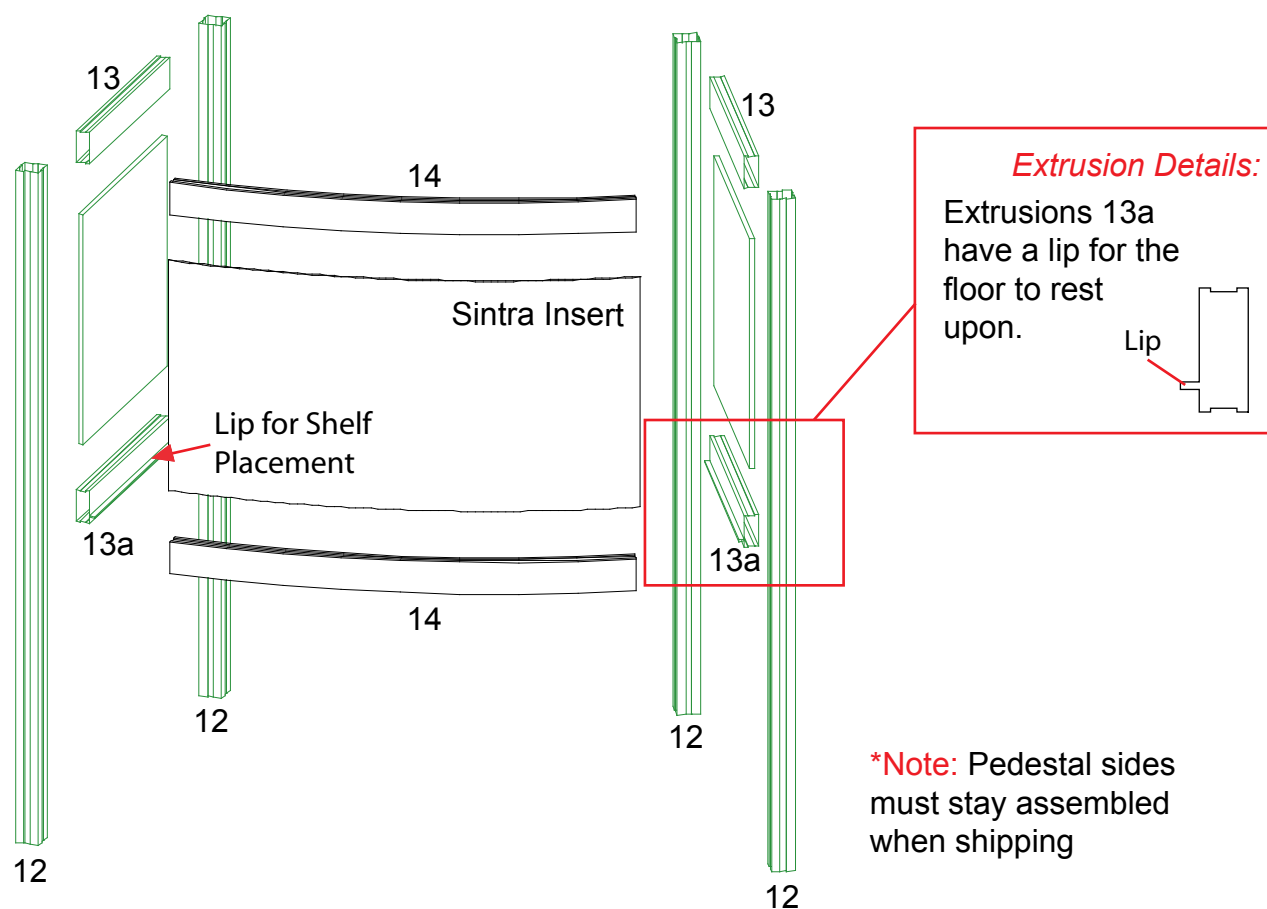
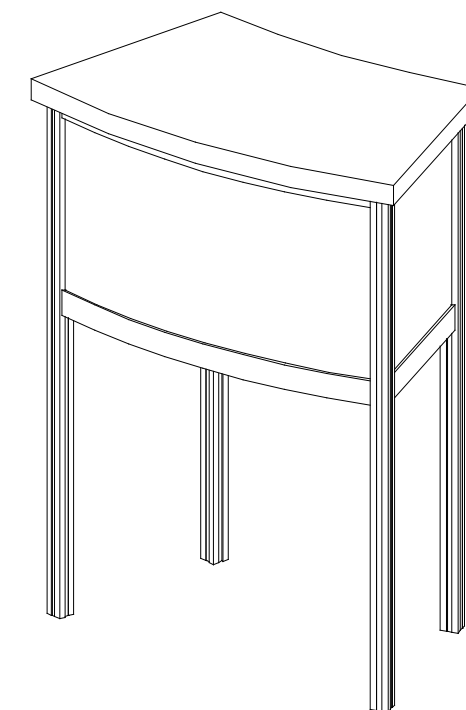

WHEN DISASSEMBLING ALUMINUM EXTRUSION, TIGHTEN ALL SETSCREWS AND LOCKS TO PREVENT LOSS DURING SHIPPING

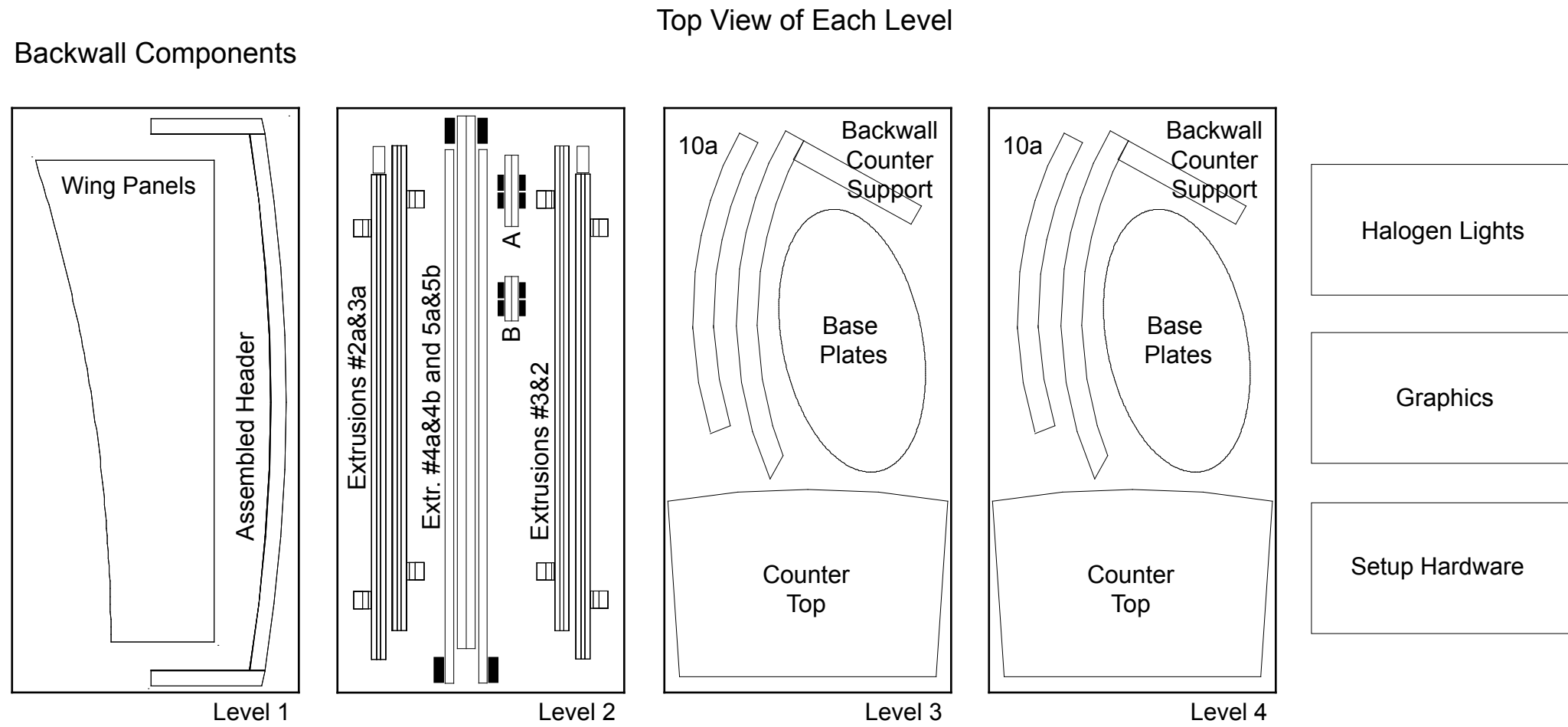

WHEN DISASSEMBLING ALUMINUM EXTRUSION, TIGHTEN ALL SETSCREWS AND LOCKS TO PREVENT LOSS DURING SHIPPING

Top View of Each Level

Pedestal Components

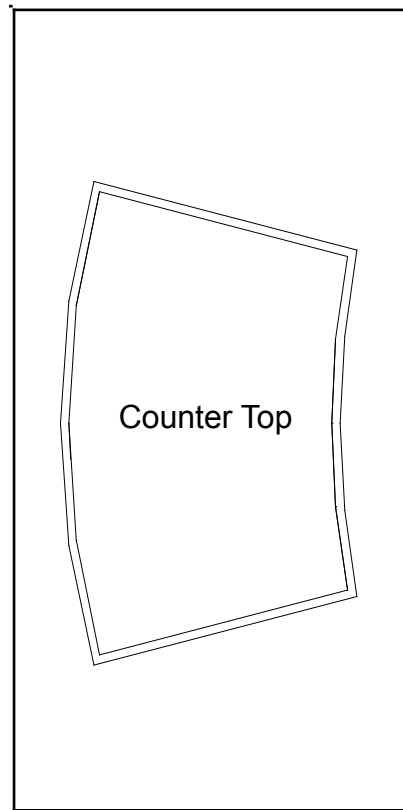

Level 1

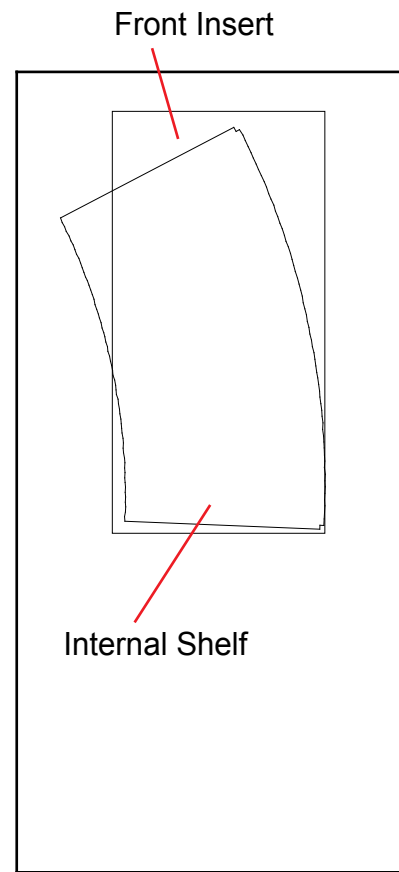

Level 2

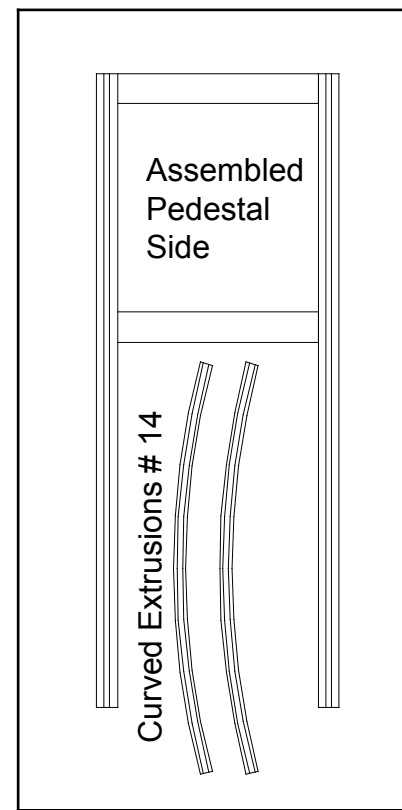

Level 3

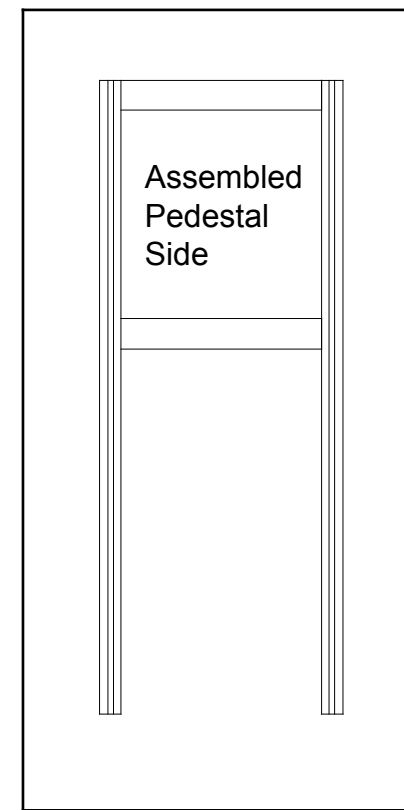

Level 4

WHEN DISASSEMBLING ALUMINUM EXTRUSION, TIGHTEN ALL SETSCREWS AND LOCKS TO PREVENT LOSS DURING SHIPPING

Top View

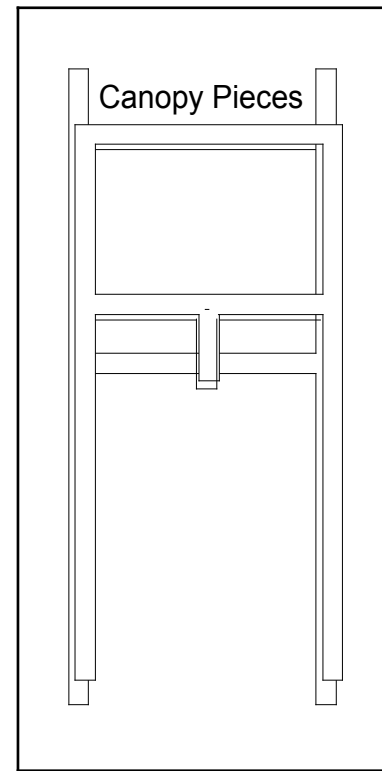

WHEN DISASSEMBLING ALUMINUM EXTRUSION, TIGHTEN ALL SETSCREWS AND LOCKS TO PREVENT LOSS DURING SHIPPING