

## General Setup Instructions

### Using Your Setup Instructions

The Setup Instructions are created specifically for your configuration. They are laid out sequentially in levels, including exploded views, and a logical series of detailed steps to assemble the main structure and components. We encourage you to study the instructions **before** attempting to assemble your exhibit.

Each page reminds you to tighten the setscrews after disassembling your exhibit to prevent loss of the locks and setscrews (see below in RED). This is **VERY IMPORTANT**.

### Cleaning and Packing Your Display

- 1) Use care when cleaning aluminum extrusion or Eco Glass inserts. Use only non-abrasive cleaners.
- 2) When cleaning laminate inserts, countertops, or panels use mild cleansers and a soft material such as cotton.
- 3) Keep all display components away from extreme heat and long exposure to sunlight to avoid warping and fading.
- 4) Retain all packing material. It will make re-packing much easier and will reduce the likelihood of shipping damage. Each Layer will be labeled with the packing order.

## General Setup Instructions for Panel System

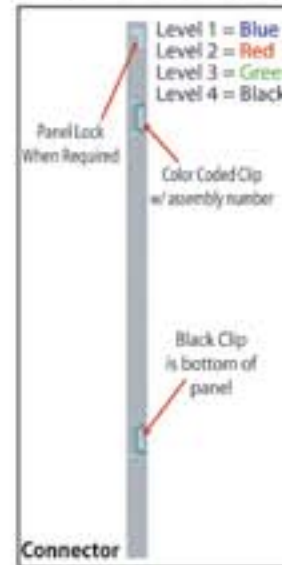

Each component has 2 clips, the lower clip is ALWAYS black. The top clip is color coded to distinguish the level. The color coded clip also contains the numbered label.

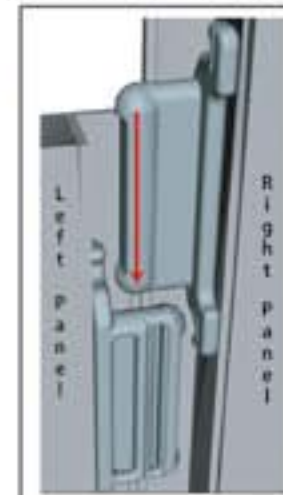

Cut Away View Of Slide Clips

Components connect together by aligning them and sliding downward connecting clips together.



Example of Connection

Configurations are assembled from left to right, usually starting with #1 and following the numbered sequence.

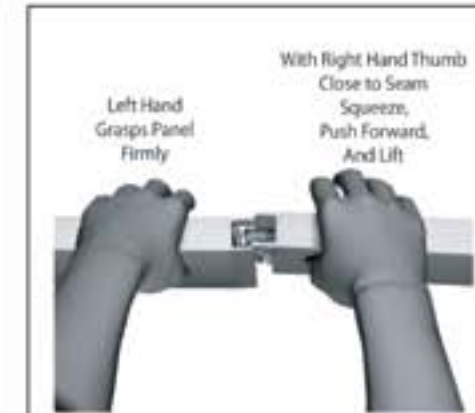

Top View of Panels with Locks

The first level of components contains panel locks that are located at the top of the panel for extra stability and a seamless connection. When disassembling panels, twist top connection slightly and lift right panel upward.

## General Setup Instructions for Extrusion System



The Tool

Most exhibits can be assembled with the supplied Hex Key Tool. Occasionally, other tools may be needed.



Typical Connection

Most horizontal extrusion connections have a patented expandable lock. This lock inserts into the groove of an opposing extrusion. Tightening the lock with the Hex Key Tool expands the lock and creates a strong positive connection.



Typical Connection (cont'd)

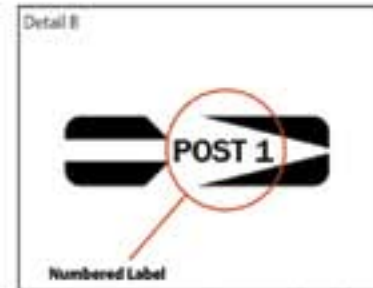

Numbered Label

Each extrusion contains a numbered label which corresponds with setup instructions. The label is located within a groove of the extrusion (when possible). With extrusion components the labels contain Black numbers unless otherwise specified.



Horizontal In-line Connection (remove only one setscrew)

Remove only (1) setscrew when disassembling. Replace setscrew in extrusion after assembling it. Before packing, replace setscrew in extrusion to avoid losing it.

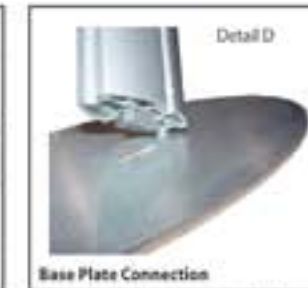

Base Plate Connection

Attach base plate to vertical extrusion using the lock provided. Place base plate on ground and set vertical post/lock in base plate slot. Tighten lock with Mult-tool.

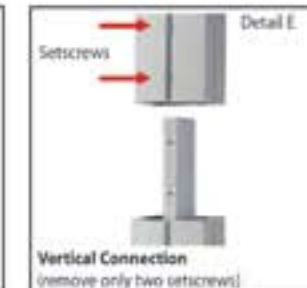

Vertical Connection (remove only two setscrews)

When vertical extrusions are packed in portable cases rather than crates or tubs, they must be broken down into smaller sections which then require assembly.

Remove only (2) setscrews when disassembling. Replace setscrews in extrusion after assembling it. Before packing, replace setscrews in extrusion to avoid losing them.

Item #	Qty.	Description
1	2	84" h Vertical Extrusion
2	2	84" h Vertical Extrusion
3	2	24" w Horizontal Extrusion
4	1	52.75" w Horizontal Extrusion
5	2	24" w Horizontal Extrusion
6	1	52.75" w Horizontal Extrusion

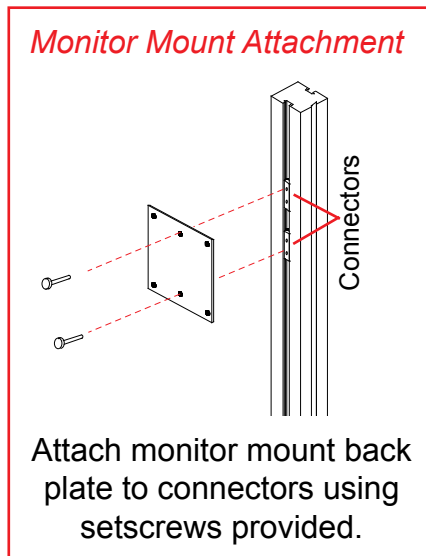
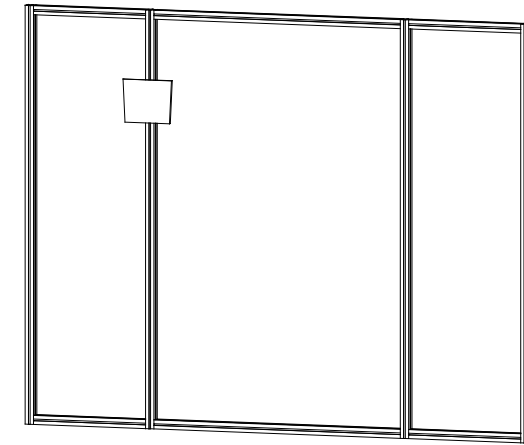

**Steps:**

- 1) Connect lower and upper horizontals between verticals.
- 2) Attach monitor mount to vertical [2]. Refer to detail.
- 3) Attach graphic to back side of assembled backwall.

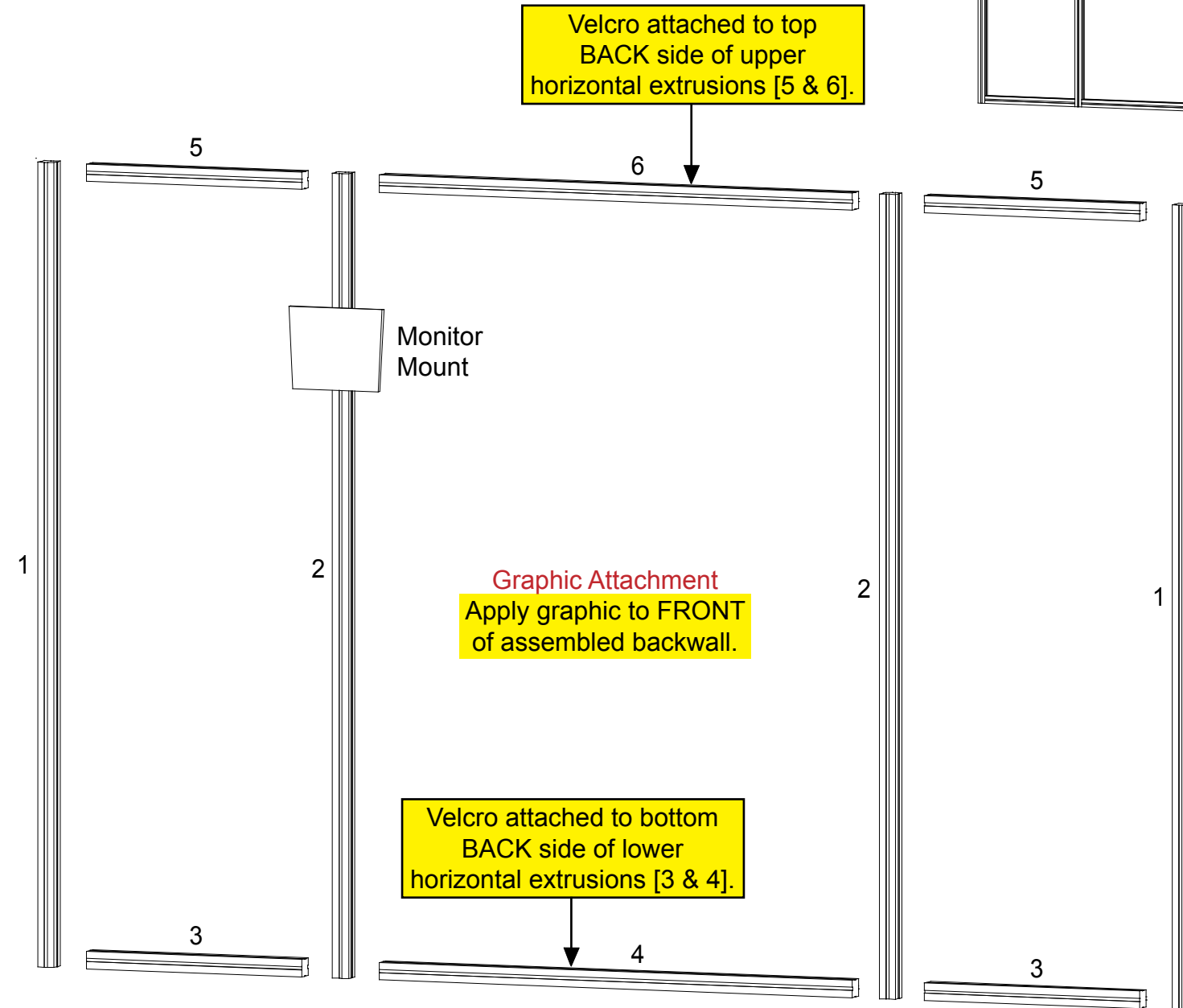

Item #	Qty.	Description
7	2	40" h Vertical Extrusion
8	2	24" w Horizontal Extrusion
9	2	24" w Horizontal Extrusion
10	2	38" h Vertical Extrusion
11	2	12" w Horizontal Extrusion

Steps:

- 1) Connect lower and upper horizontals [8 and 9] between verticals [1 and 7].  
Note: Place insert between horizontals and verticals.
- 2) Attach vertical [10] atop horizontal [9] and horizontal [11] between verticals [1 and 10].  
Note: Place insert between horizontals and verticals.
- 3) Velcro attach two counters atop horizontal [9].

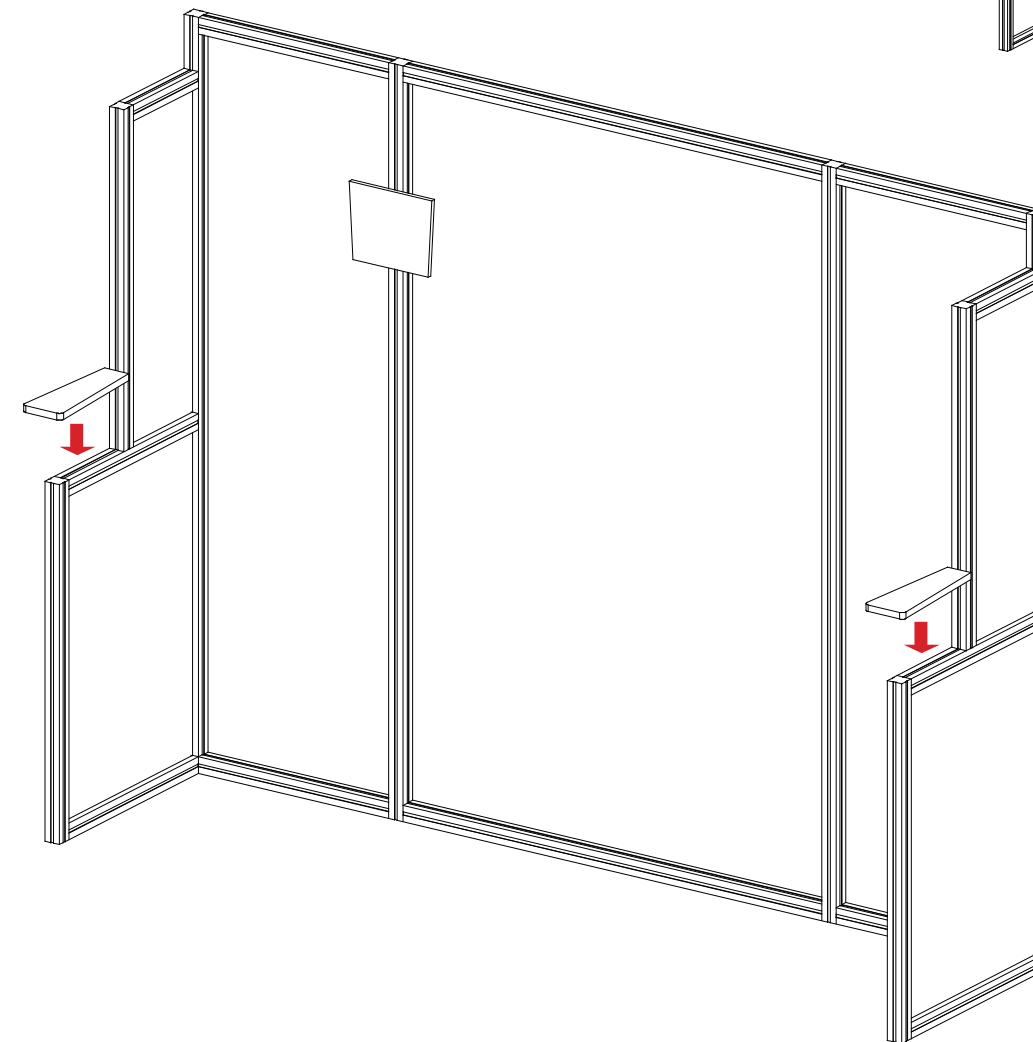
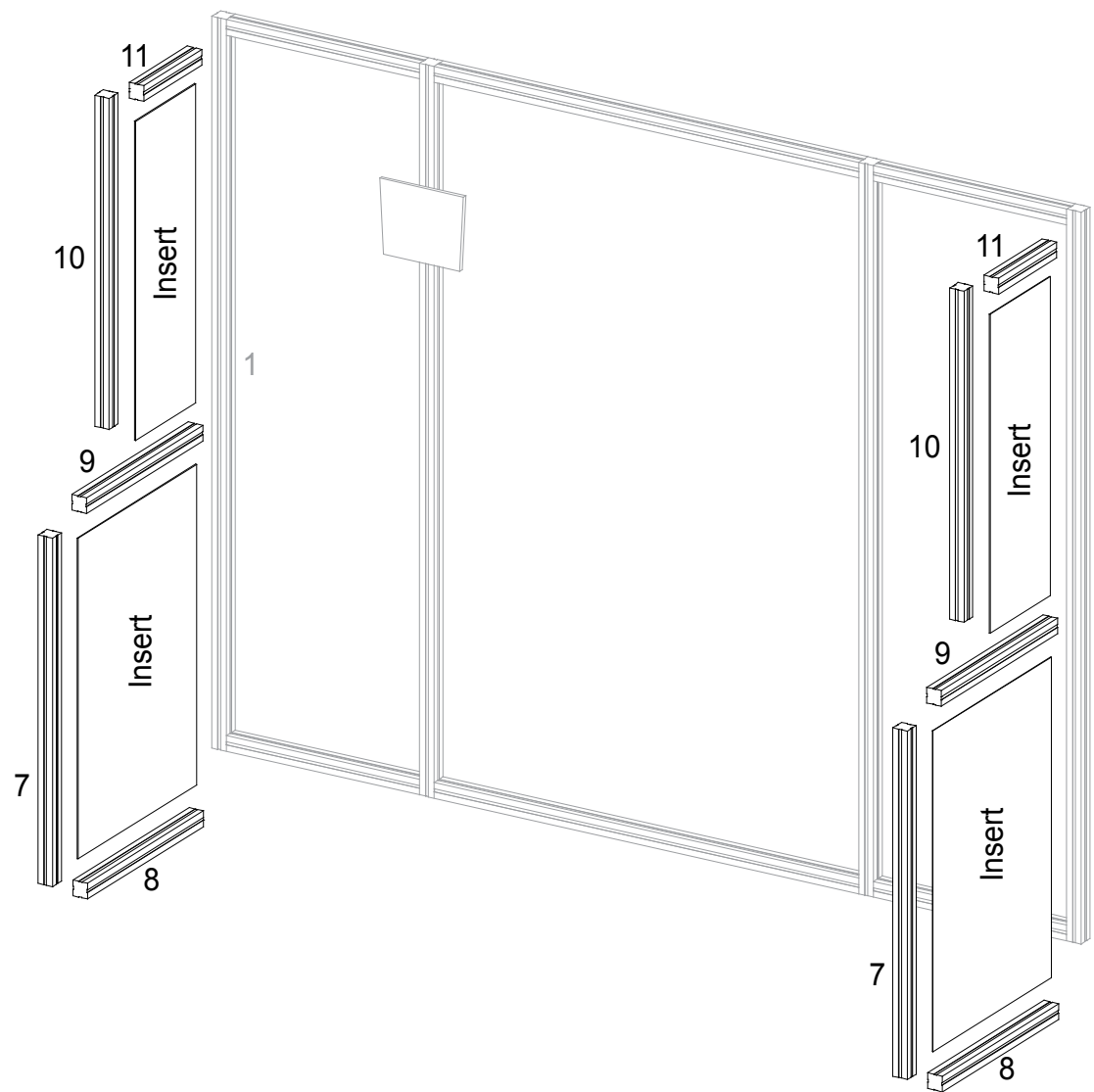
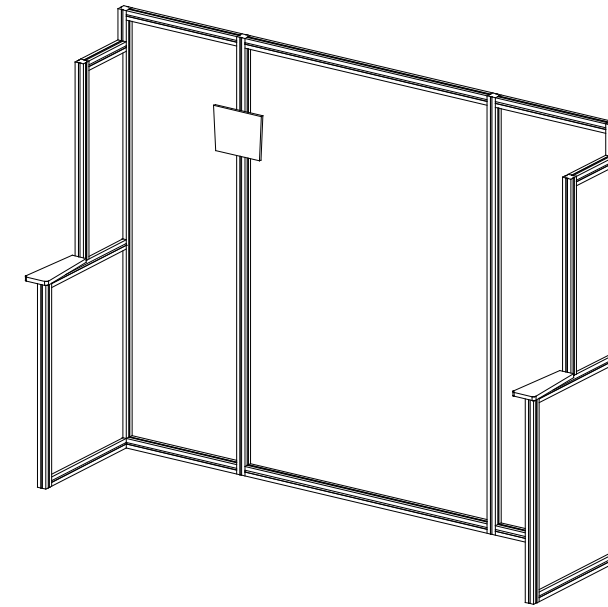

Item #	Qty.	Description
12	1	Canopy Extrusion
13	1	Canopy Extrusion

Steps:

- 1) Attach vertical extrusion [14] atop backwall.
- 2) Attach assembled canopy to backwall as shown.
- 3) Attach cable between vertical [14] and canopy for canopy support.
- 4) Attach light atop backwall. Refer to detail.

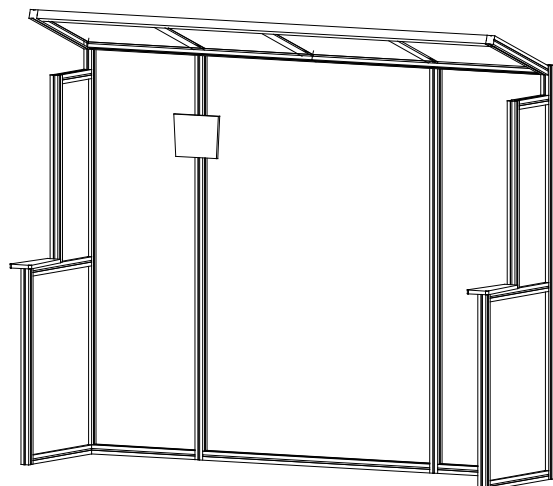

When all assembled

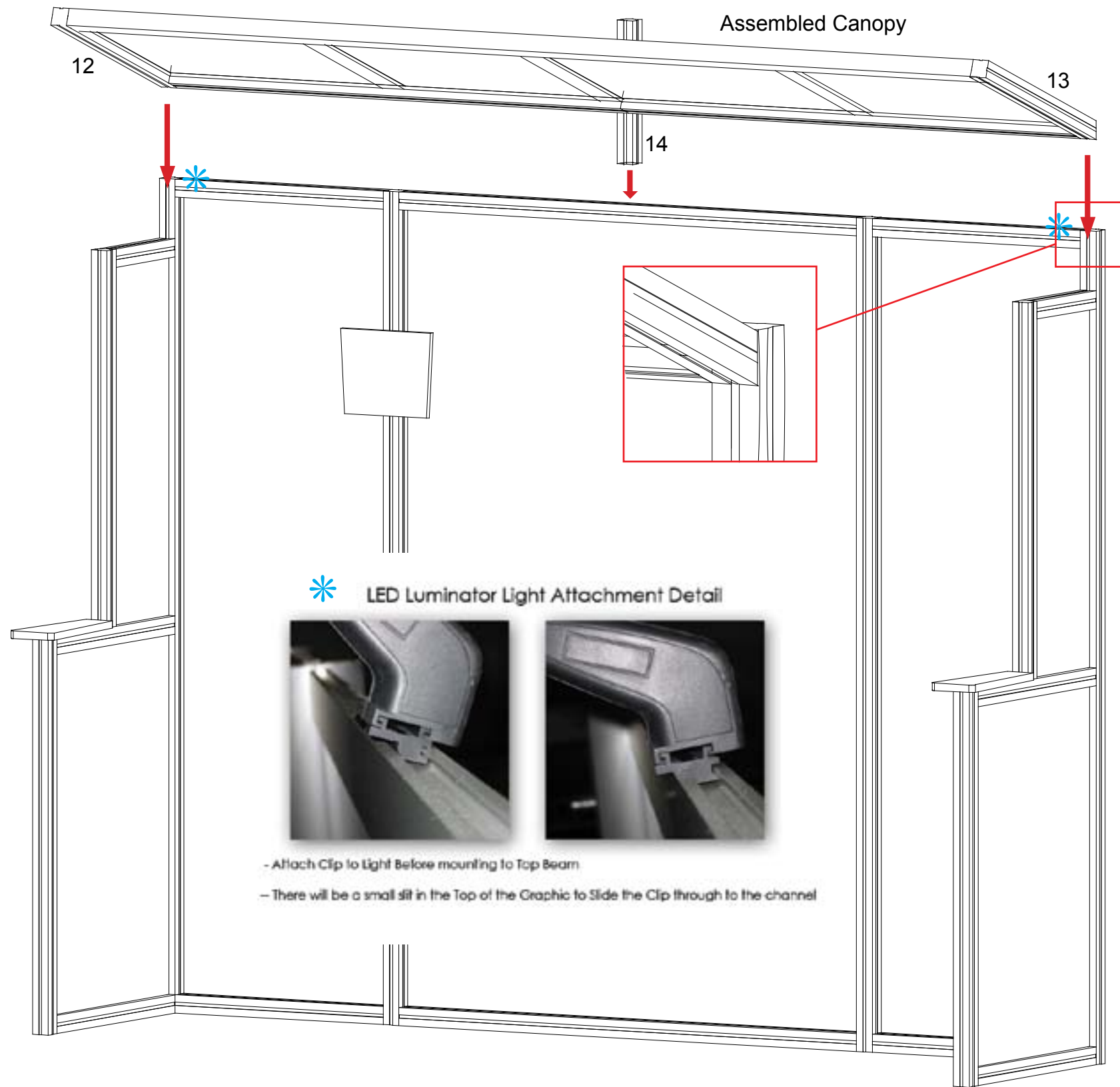
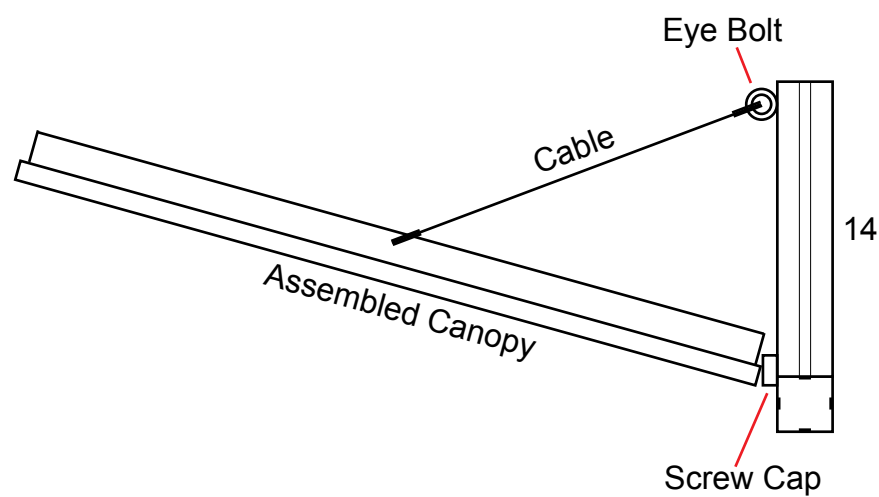

\* LED Luminator Light Attachment Detail



- Attach Clip to Light Before mounting to Top Beam.
- There will be a small slit in the Top of the Graphic to Slide the Clip through to the channel



Level 1



Level 2



Level 3

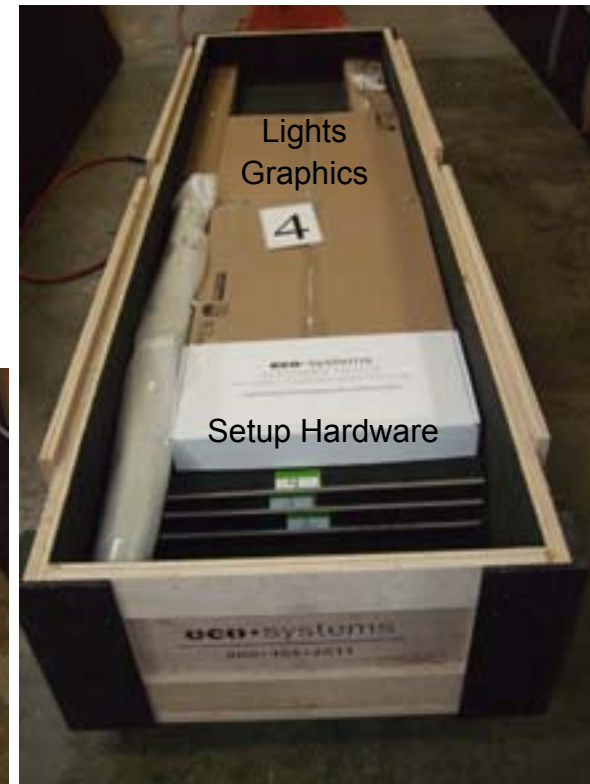

Level 4

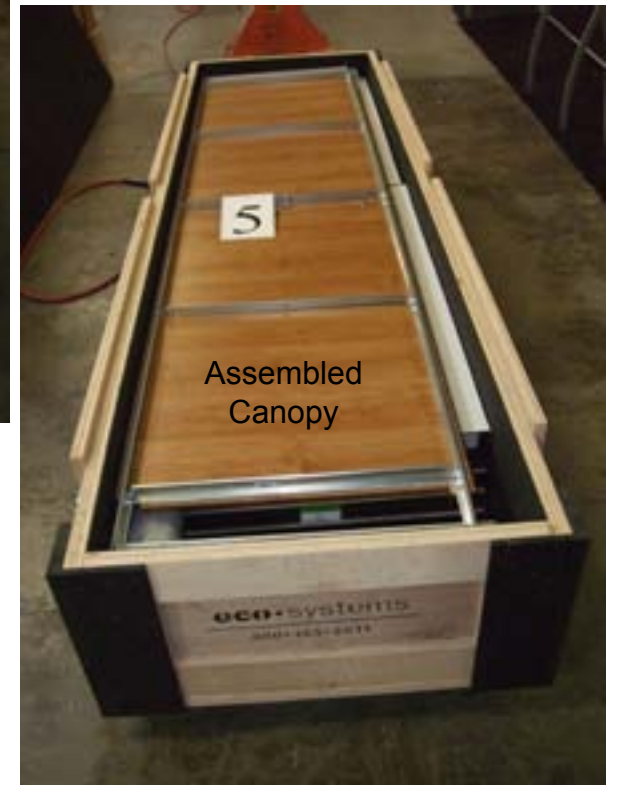

Level 5