

euro It | HYBRIDS

Item	Qty.	Description
1	1	Oval Base Plate
2	1	Lower Square Extrusion
3	1	Upper Square Extrusion

Steps:

- 4) Connect upper and lower vertical extrusions together.
- 5) Using door opening, attach assembled vertical extrusion to back panel of assembled pedestal base using bolts.
- 6) Place counter top on assembled pedestal base.

Steps:

- 1) Use standoff screws to secure the front panel with door and back panel of the pedestal to the side panels.
- 2) After assembling front, back, and side panels, slide floor into the bottom of the pedestal. The floor will sit on pins on the inside of the side panels.
- 3) After floor is in place, use velcro attachments to install shelf.

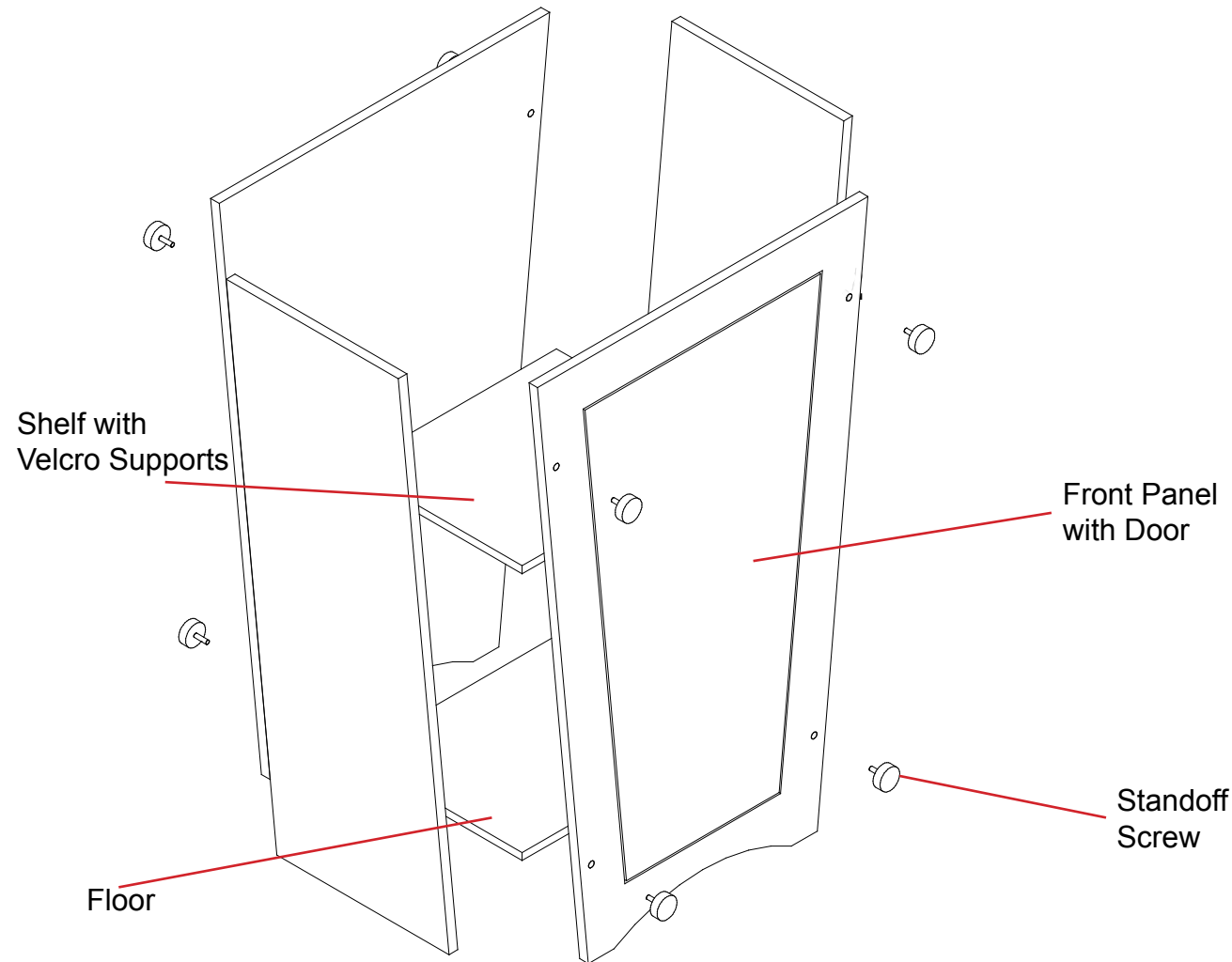

Set oval counter top to the pedestal base.

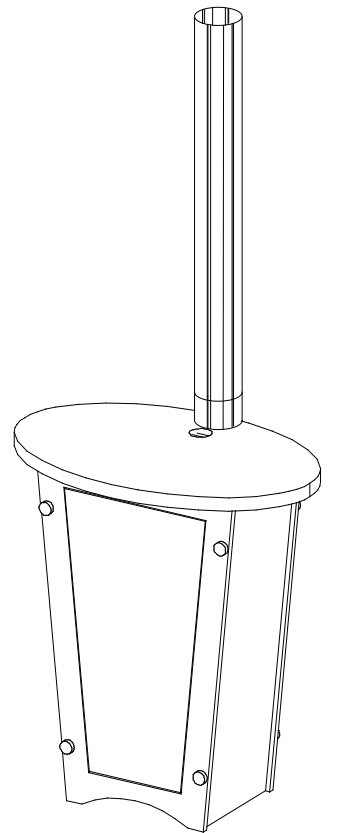
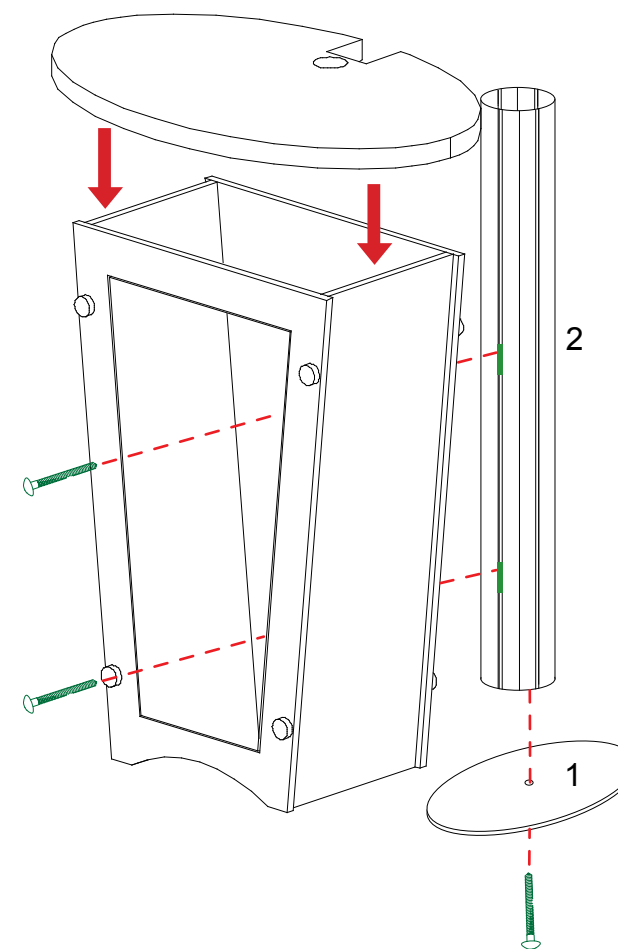

Monitor Mount Attachment

Connectors

Attach back plate to connectors on vertical extrusion using screws. Then attach top plate and tighten setscrews to secure.

WHEN DISASSEMBLING ALUMINUM EXTRUSION, TIGHTEN ALL SETSCREWS AND LOCKS TO PREVENT LOSS DURING SHIPPING

euro It | HYBRIDS

Using Your Setup Instructions







The Euro LT Hybrids Setup Instructions are created specifically for your configuration. They are laid out sequentially in levels, including exploded views, and a logical series of detailed steps to assemble the main structure and components. We encourage you to study the instructions **before** attempting to assemble your exhibit.

Each page reminds you to tighten the setscrews after disassembling your exhibit to prevent loss of the locks and setscrews (see below in RED). This is **VERY IMPORTANT**.

Cleaning and Packing Your Display

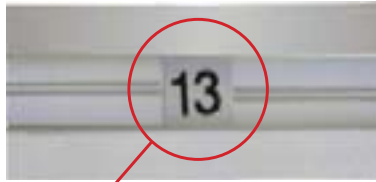
- 1) Use care when cleaning aluminum extrusion or acrylic inserts. Use only non-abrasive cleaners.
- 2) When cleaning laminate inserts, countertops, or panels use mild cleansers and a soft material such as cotton.
- 3) Keep all display components away from extreme heat and long exposure to sunlight to avoid warping and fading.
- 4) Retain all packing material. It will make re-packing much easier and will reduce the likelihood of shipping damage.

General Setup Instructions for Extrusion System

 <p>The Tool</p>	 <p>Typical Connection</p>	 <p>Typical Connection (cont'd)</p>	 <p>Numbered Label</p>	 <p>Horizontal Inline Connection (remove only one setscrew)</p>	 <p>Base Plate Connection</p>	 <p>Vertical Connection (remove only two setscrews)</p>
<p>Most exhibits can be assembled with the supplied Hex Key Tool. Occasionally, a flat head screwdriver may be required.</p>	<p>Most horizontal extrusion connections have a patented expandable lock. This lock inserts into the groove of an opposing extrusion. Tightening the lock with the Hex Key Tool expands the lock and creates a strong positive connection.</p>	<p>Each extrusion contains a numbered label which corresponds with setup instructions. The label is located within a groove of the extrusion (when possible). With extrusion components the labels contain Black numbers unless otherwise specified.</p>	<p>Remove only (1) setscrew when disassembling. Replace setscrew in extrusion after assembling it. Before packing, replace setscrew in extrusion to avoid losing it.</p>	<p>Attach base plate to round or square vertical extrusion using the bolt provided. Be careful not to strip the threads.</p>	<p>When vertical extrusions are packed in portable cases rather than crates or tubs, they must be broken down into smaller section which then require assembly.</p>	<p>Remove only (2) setscrews when disassembling. Replace setscrews in extrusion after assembling it. Before packing, replace setscrews in extrusion to avoid losing them.</p>

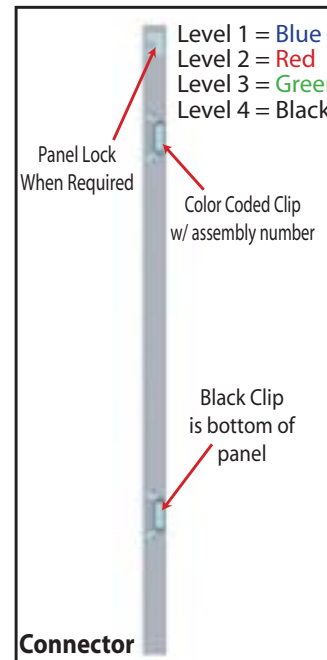

Each component has 2 clips, the lower clip is ALWAYS black. The top clip is color coded to distinguish which level. The color coded clip also contains the numbered label.

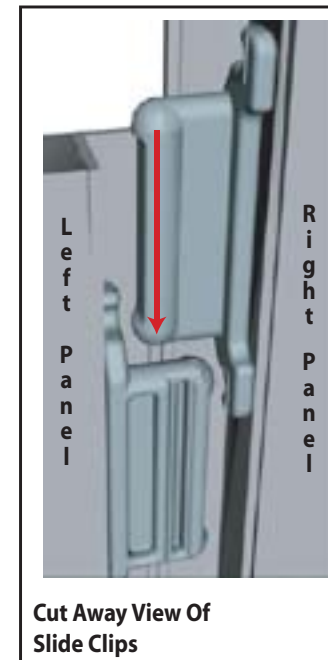

Components connect together by aligning them and sliding downward connecting clips together.

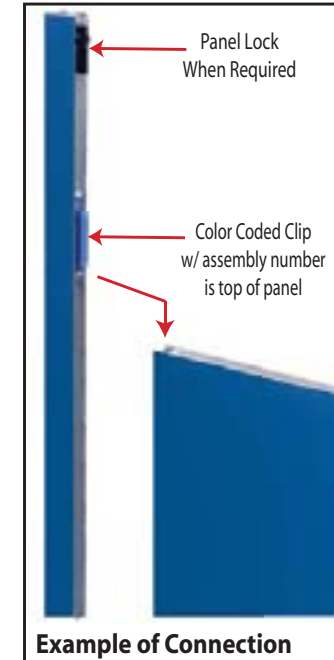

Configurations are assembled from left to right, usually starting with #1 and following the numbered sequence.

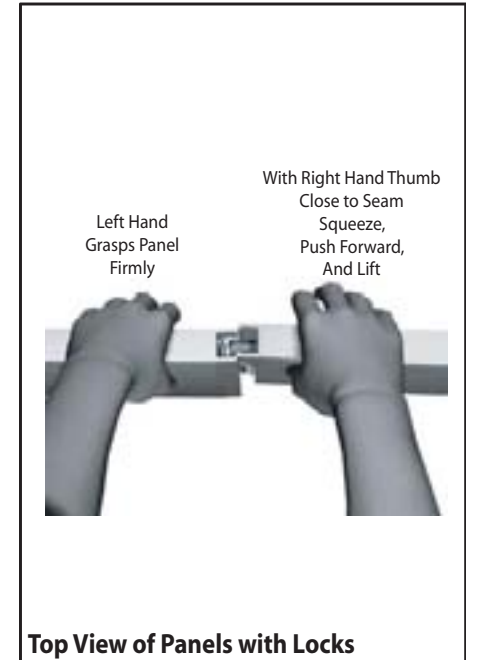

The first level of components contain panel locks that are located at the top of the panel for extra stability and seamless connection. When disassembling panels twist top connection slightly and lift right panel upward.

WHEN DISASSEMBLING ALUMINUM EXTRUSION, TIGHTEN ALL SETSCREWS AND LOCKS TO PREVENT LOSS DURING SHIPPING

Top View

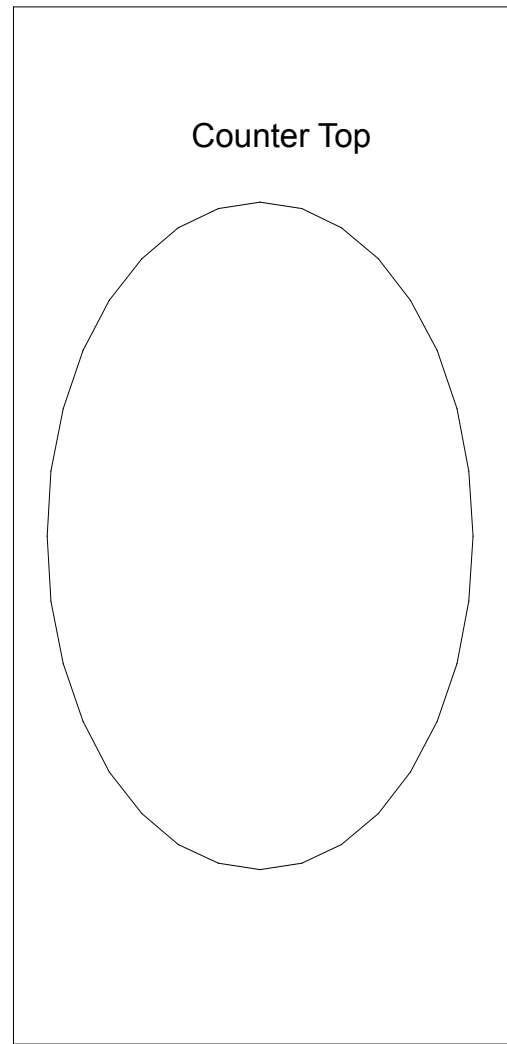

Level 1

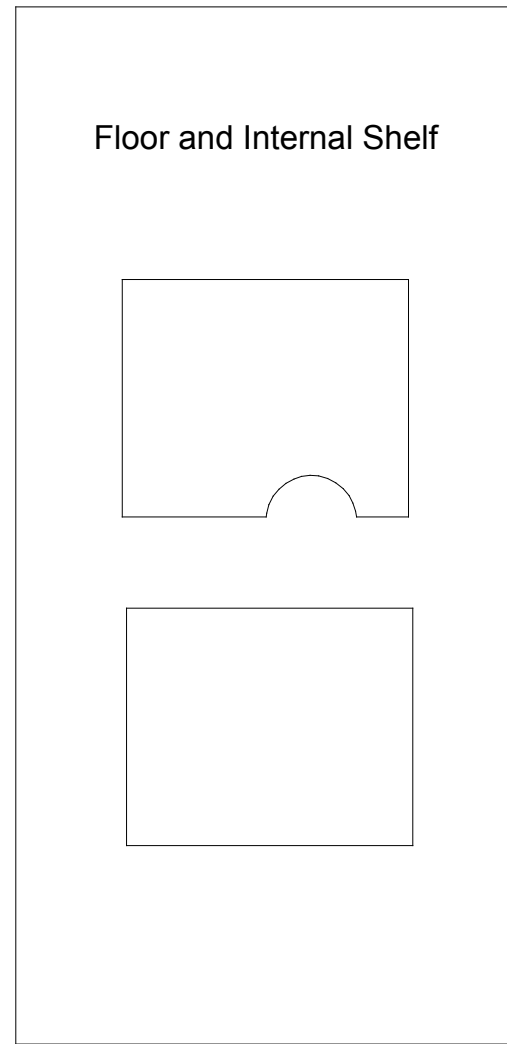

Level 2

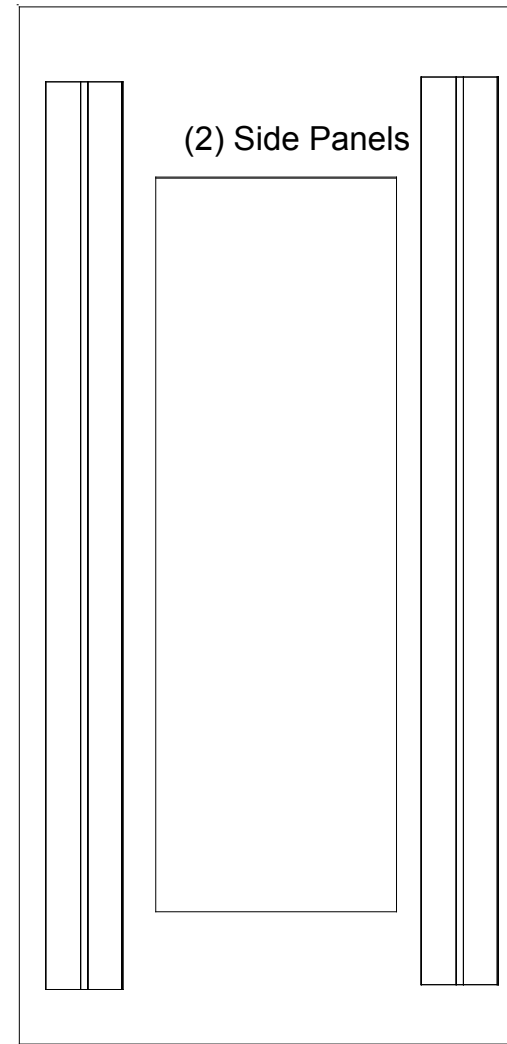

Level 3

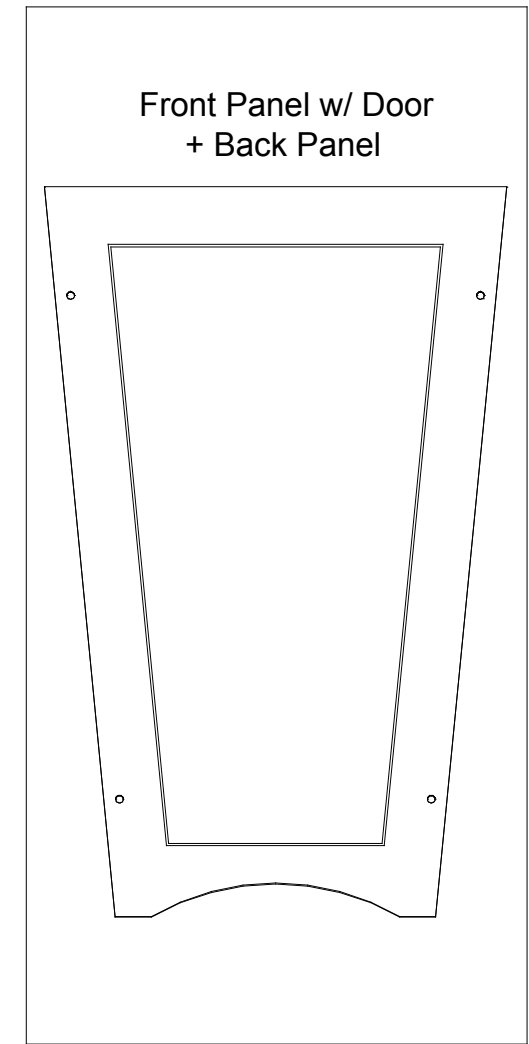

Level 4

WHEN DISASSEMBLING ALUMINUM EXTRUSION, TIGHTEN ALL SETSCREWS AND LOCKS TO PREVENT LOSS DURING SHIPPING