

# SACAGAWEA DESIGNS

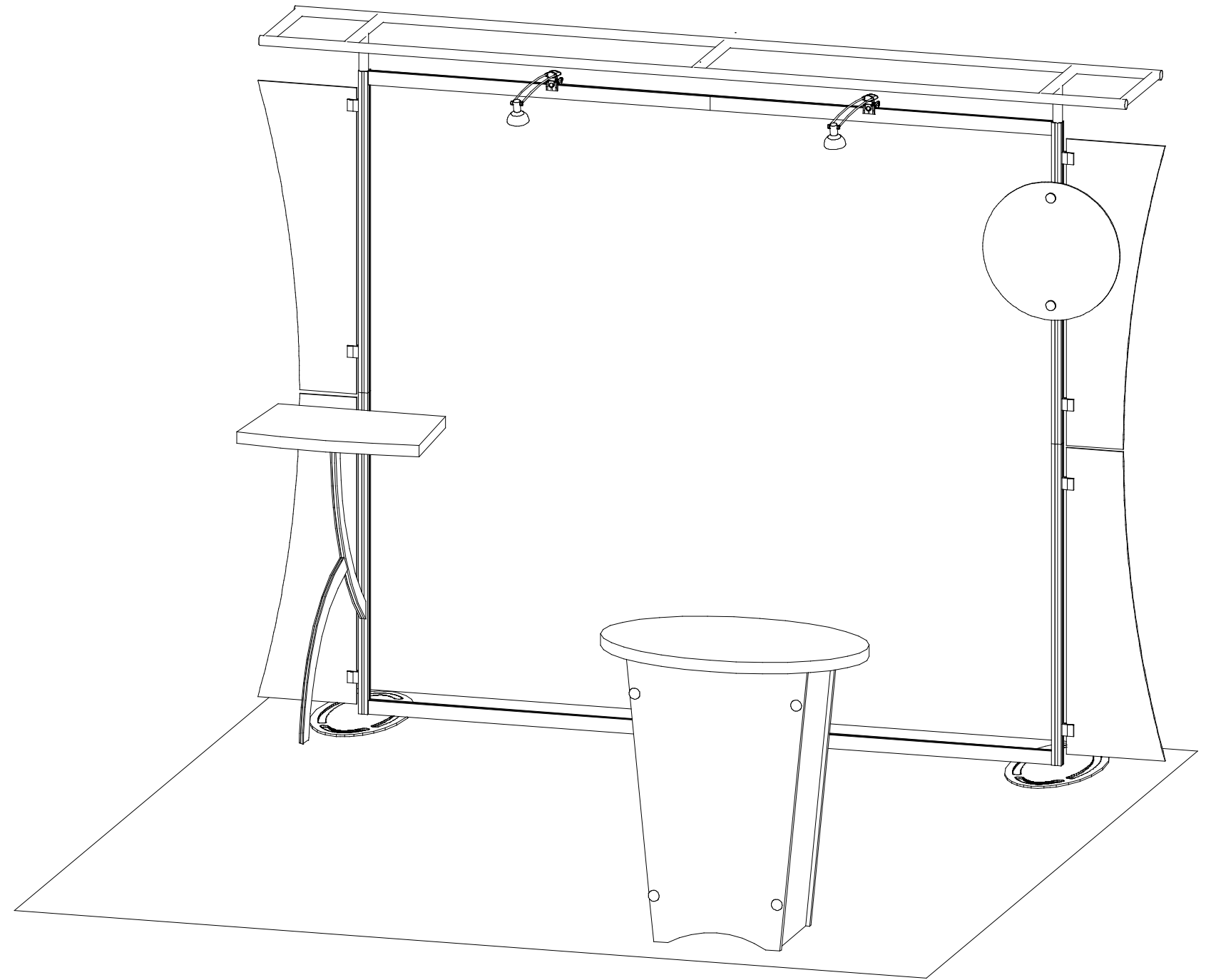
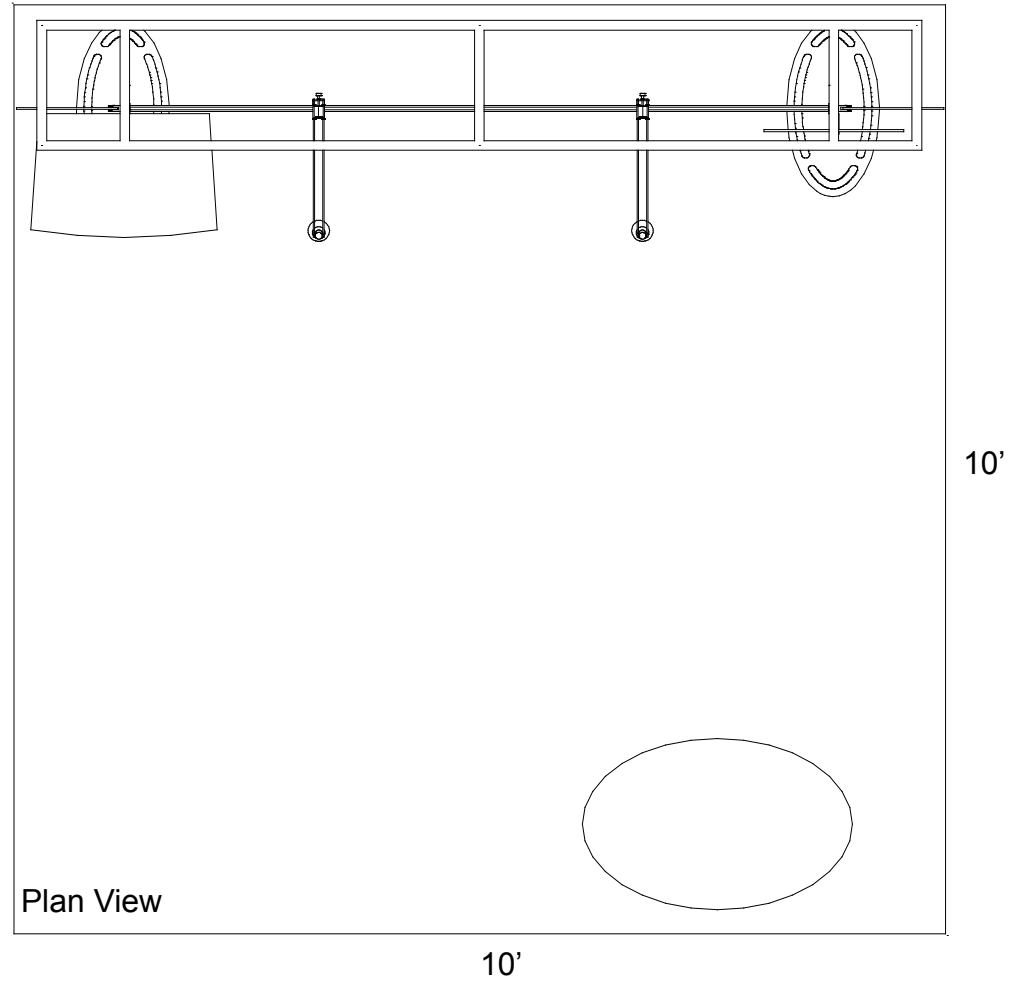

WHEN DISASSEMBLING ALUMINUM EXTRUSION, TIGHTEN ALL SETSCREWS AND LOCKS TO PREVENT LOSS DURING SHIPPING

# SACAGAWEA DESIGNS

## Using Your Set-up Instructions:

The Visionary Designs Set-up Instructions for Sacagawea displays are created specifically for your configuration. They are laid out sequentially, including an exploded view of the entire display and a logical series of detailed steps for assembly. We encourage you to study the instructions **before** attempting to assemble your exhibit.

### THIS IS VERY IMPORTANT!

Each page reminds you to tighten the setscrews after disassembling your exhibit to prevent loss of the locks and setscrews (see below in red).

## Cleaning & Packing Your Display:

- 1) Use care when cleaning aluminum extrusions or acrylic inserts. Use only non-abrasive cleaners.
- 2) When cleaning laminate inserts or counter tops, use mild cleansers and a soft material such as cotton.
- 3) Keep all display components away from extreme heat and long exposure to sunlight to avoid warping and fading.
- 4) Retain all packing materials. It will make re-packing much easier and will reduce the likelihood of shipping damage.

Hex Key Tool



Most visionary design exhibits can be assembled with the supplied Hex Key Tool. Occasionally, a flat head screwdriver may be required.

Typical Connection



Detail A: Most horizontal extrusion connections have a patented expandable lock. This lock inserts into the groove of an opposing extrusion. Tightening the lock with the Hex Key Tool expands the lock and creates a strong positive connection.

Typical Connection

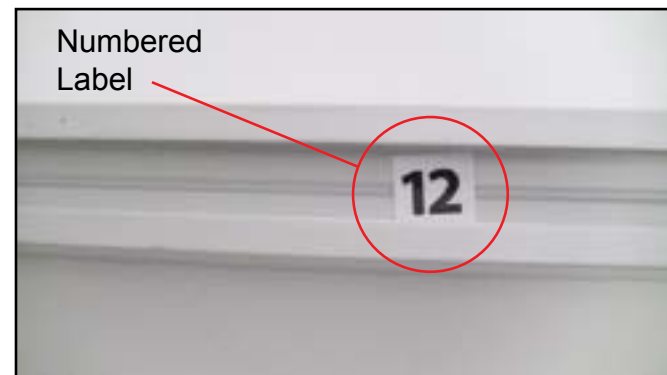

Detail B: Each extrusion contains a numbered label that corresponds to set-up instructions. The label is located within a groove of the extrusion (when possible). Visionary Design labels contain Black numbers unless otherwise specified.

Horizontal Connection



Detail C: A rectangular connection bar with plastic T Knobs is inserted between two horizontal extrusions joined end-to-end. Turn the knobs clockwise to tighten.

Do Not Overtighten.

Base Plate Connection



Detail D: Attach vertical extrusions to base plates with supplied bolts inserted through the hole in the plate. Be careful not to strip the thread.

Vertical Connection



Detail E: A square connection bar with plastic T Knobs is inserted between two vertical extrusions joined end-to-end. Turn the knobs clockwise to tighten.

Do Not Overtighten.

Corner Connection



Detail F: Plastic Star Knobs are used to tighten locks where horizontal extrusions connect with vertical extrusions. Turn the knobs clockwise to tighten. Turn counter-clockwise to loosen, but do not remove knob.

Do Not Overtighten.

**WHEN DISASSEMBLING ALUMINUM EXTRUSION, TIGHTEN ALL SETSCREWS AND LOCKS TO PREVENT LOSS DURING SHIPPING**

866.652.2100

Item	Qty.	Description
1	2	Base Plate
2a/2b	1/1	42" Vertical Extrusion
3a/3b	1/1	42" Vertical Extrusion
4a/4b	1/1	45" Horizontal Extrusion
5a/5b	1/1	45" Horizontal Extrusion

- Steps:
- 1) Attach base plates [1] to lower verticals [2a,3a] with bolts.
  - 2) Connect upper verticals [2b,3b] to lower verticals [2a,3a] with connection bars [b].
  - 3) Connect horizontals [4a,4b] and [5a,5b] with connection bars [a].
  - 4) Connect vertical assemblies [2a/2b,3a/3b] with horizontal assemblies [4a/4b,5a/5b] as shown.
  - 5) Attach graphics to **velcro** on back side of frame.

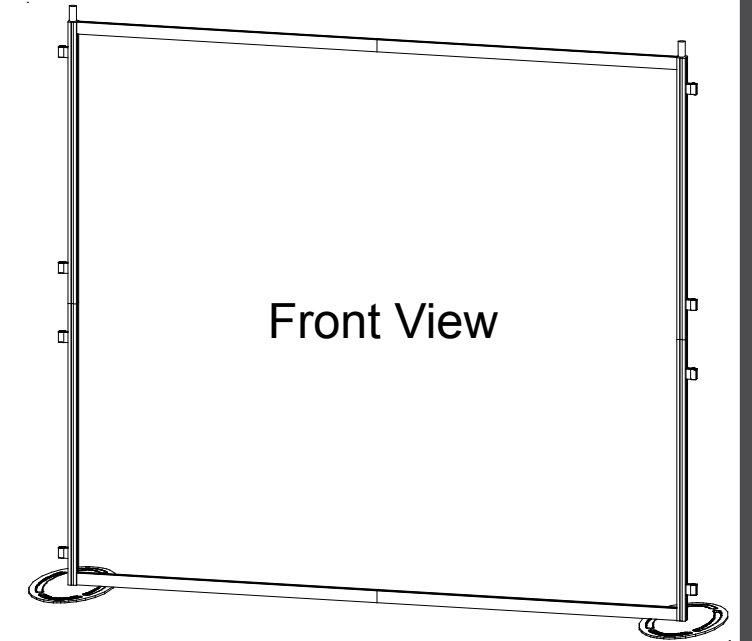

Front View

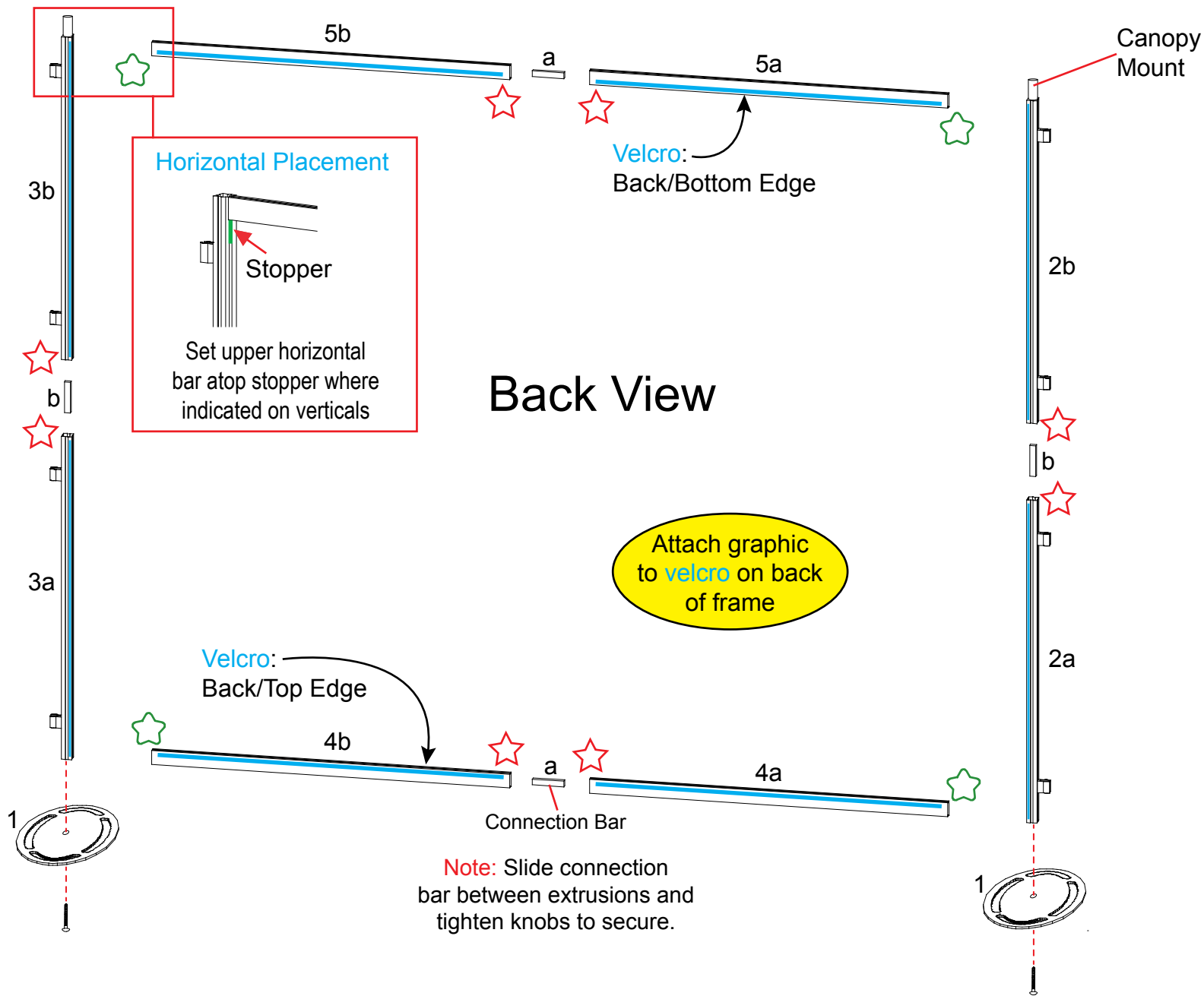
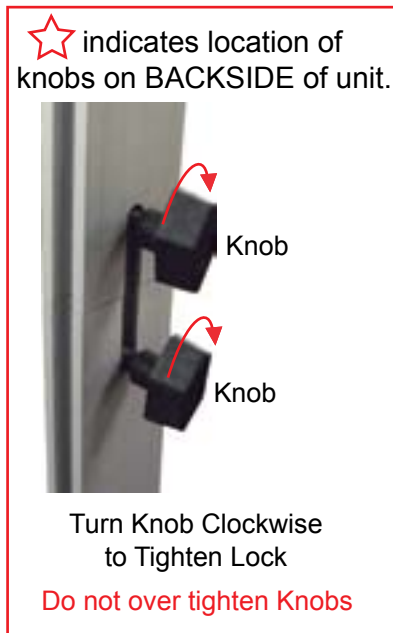

WHEN DISASSEMBLING ALUMINUM EXTRUSION, TIGHTEN ALL SETSCREWS AND LOCKS TO PREVENT LOSS DURING SHIPPING

866.652.2100

Steps:

- 1) Attach lights as indicated.
- 2) Attach assembled counter support [10/11] to vertical where indicated.
- 3) Attach support leg [10a] to counter support [10/11].
- 4) Attach flange plate [11a] to top of curved extrusion [10] as shown.
- 5) Attach counter top to support, see [counter top attachment](#) detail.
- 6) Attach wings to A10 clamps as shown.
- 7) Attach round sign to backwall frame as indicated.
- 8) Attach monitor mount to backwall, see [monitor mount attachment](#) detail.

Item	Qty.	Description
10	1	30.2" Curved Extrusion
10a	1	Leg Support
11	1	12.184"w Horizontal Extrusion
11a	1	Flange Plate

Wing Attachment

Slide A10 Clamp into groove of square extrusion.

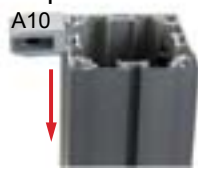

When desired location is found, tighten set screw to secure.



Tighten black plastic set screw to secure Wing in place.



Keep A10 clamps attached to verticals

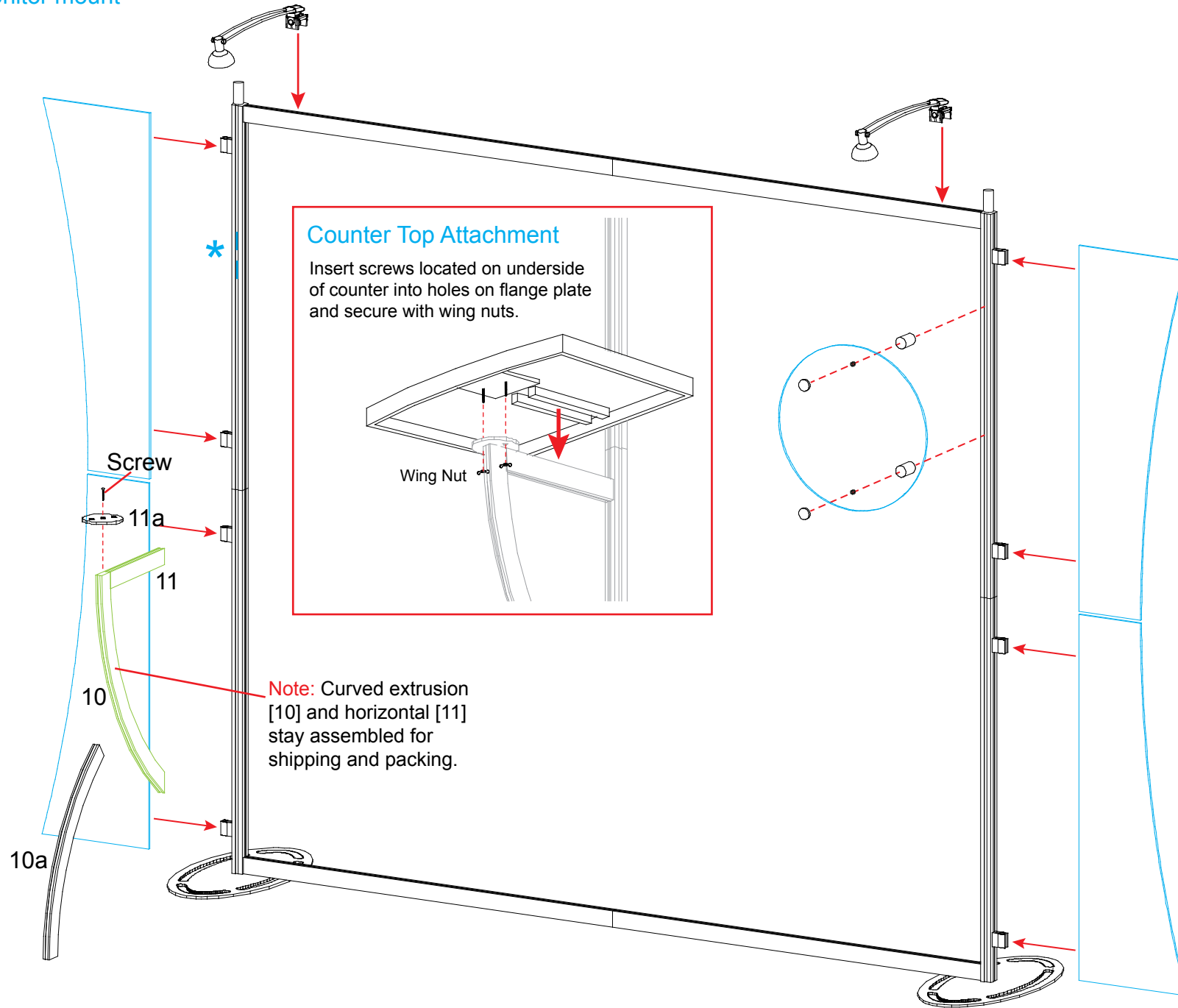

**Monitor Mount Attachment**

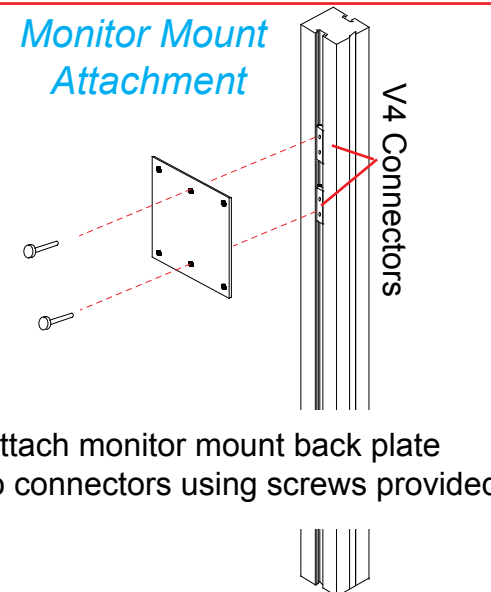

Attach monitor mount back plate to connectors using screws provided.

Graphic Attachment

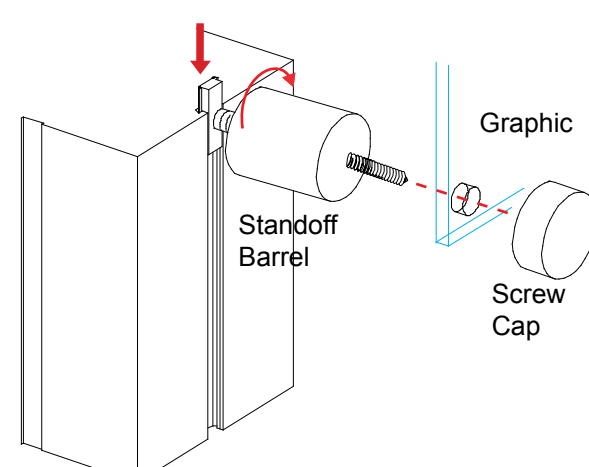

Slide connector on back of standoff barrel into groove of extrusion and twist to secure in place. Secure graphic to standoffs using screw cap.

**WHEN DISASSEMBLING ALUMINUM EXTRUSION, TIGHTEN ALL SETSCREWS AND LOCKS TO PREVENT LOSS DURING SHIPPING**



**Steps:**

- 1) Connect canopy pieces together as shown.
- 2) Apply pillow case graphic to assembled canopy

**Using Your Setup Instructions**

The Aero Overhead Sign Setup Instructions are created specifically for your configuration. They include an exploded view of the frame which is sequentially numbered. We encourage you to study the instructions before attempting to assemble your exhibit.

Connections are kept very simple: no tools. Everything assembles with push-button connectors and pre-connected horizontal sections.

**Cleaning and Packing Your Display**

- 1) Use care when cleaning aluminum extrusion or acrylic inserts. Use only non-abrasive cleaners.
- 2) Retain all packing material. It will make re-packing much easier and will reduce the likelihood of shipping damage.

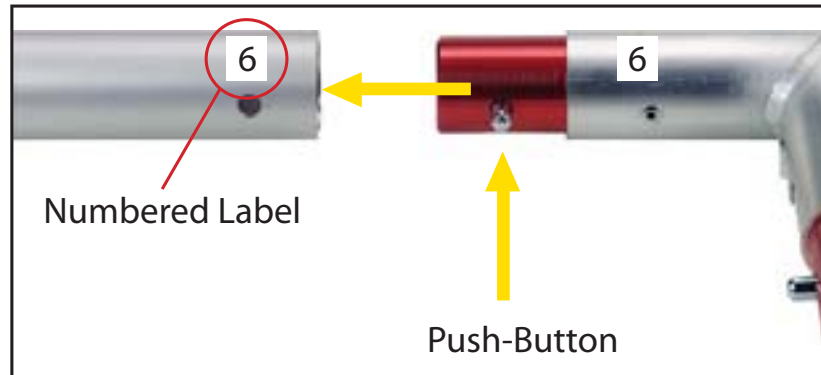
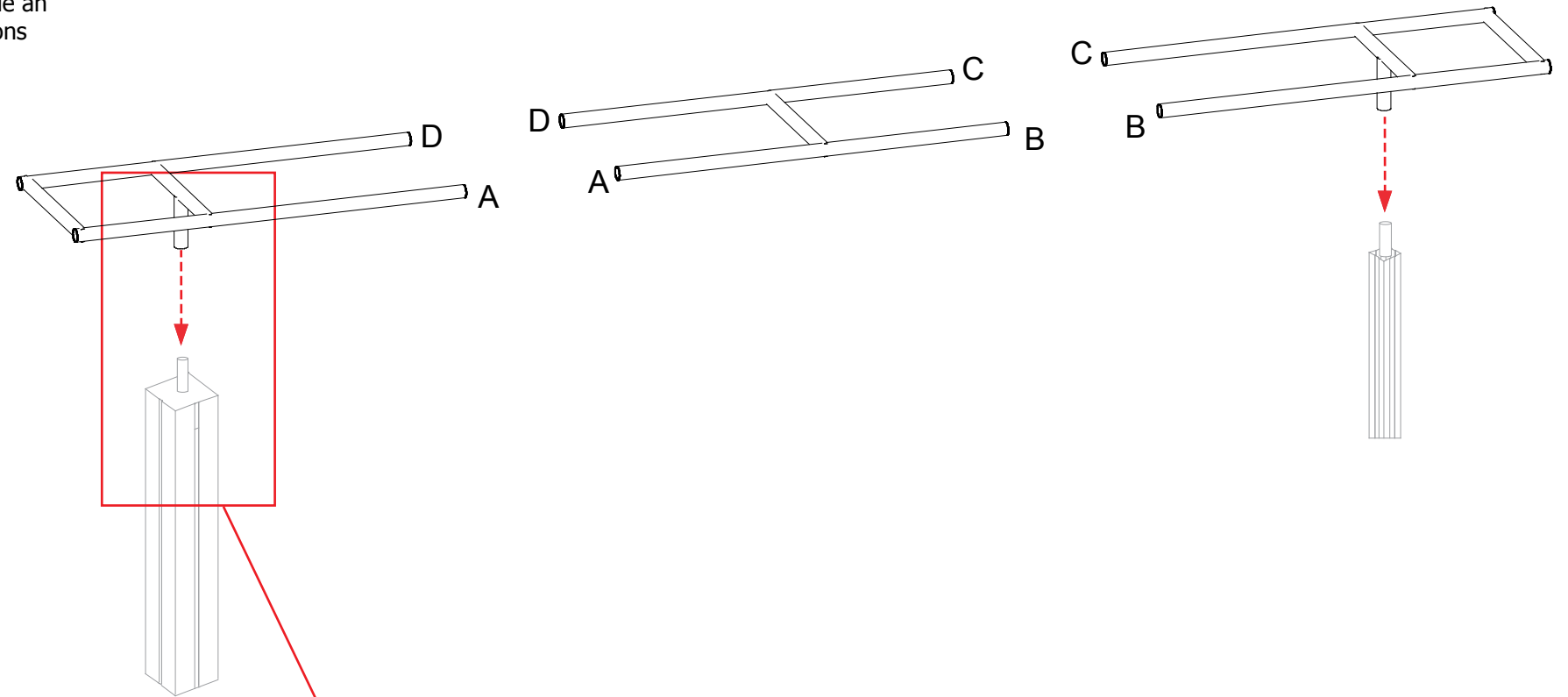

Connections are made by holding the button down and sliding the red tube into opposing tube until the connection is made. To disassemble push button and pull or twist extrusions apart.

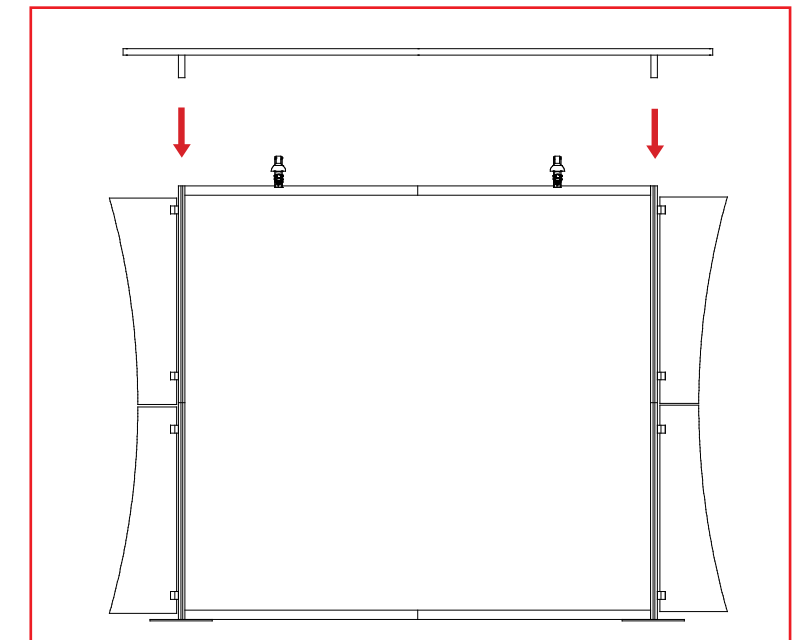
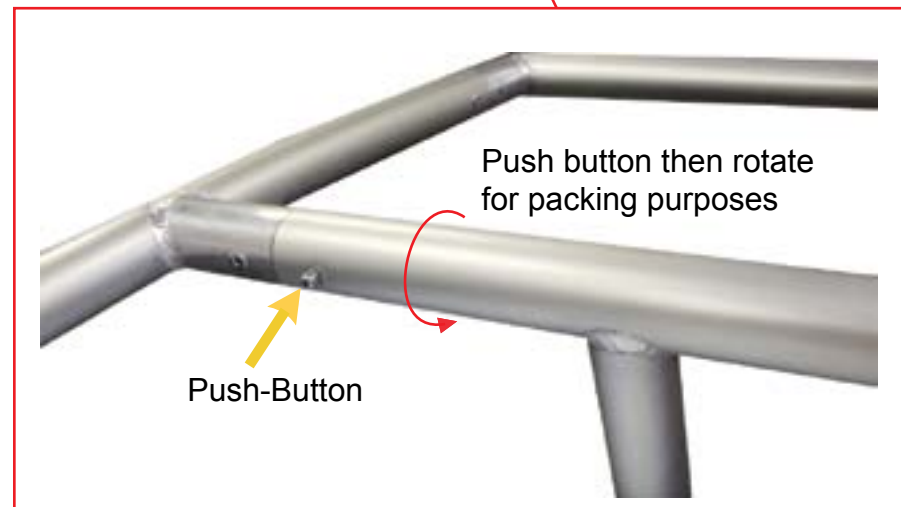
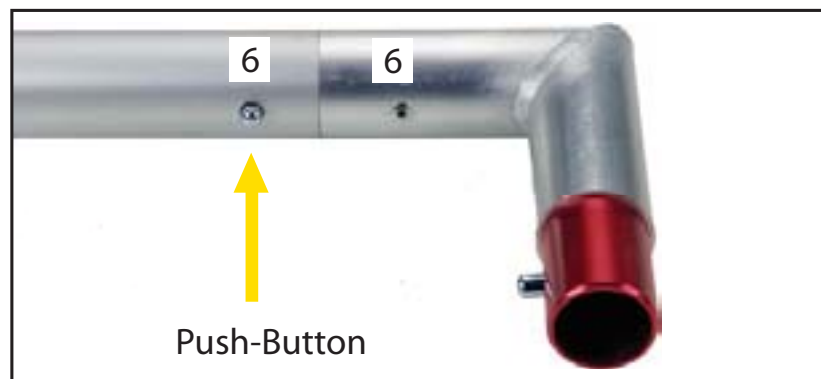

**WHEN DISASSEMBLING ALUMINUM EXTRUSION, TIGHTEN ALL SETSCREWS AND LOCKS TO PREVENT LOSS DURING SHIPPING**



866.652.2100

Setup Instructions:

- A) Use standoff screws to secure the front panel with door and back panel of the pedestal to the side panels.
- B) After assembling front, back, and side panels, slide floor into the bottom of the pedestal. The floor will sit on pins on the inside of the side panels.
- C) After floor is in place, velcro shelf supports in corners, and place shelf on top of supports.
- D) Place counter top on top of assembled base.

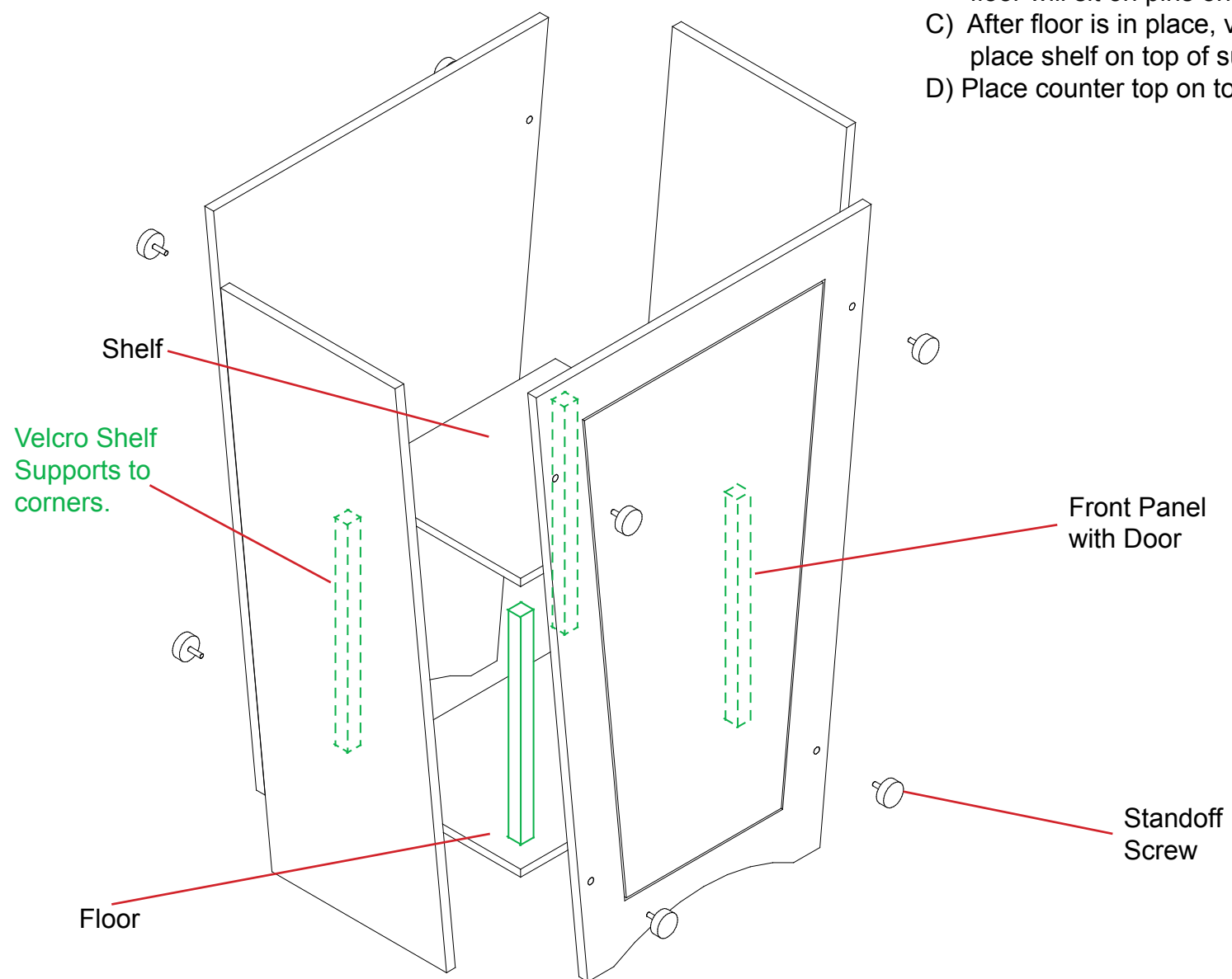

Place the oval counter top of the pedestal base.

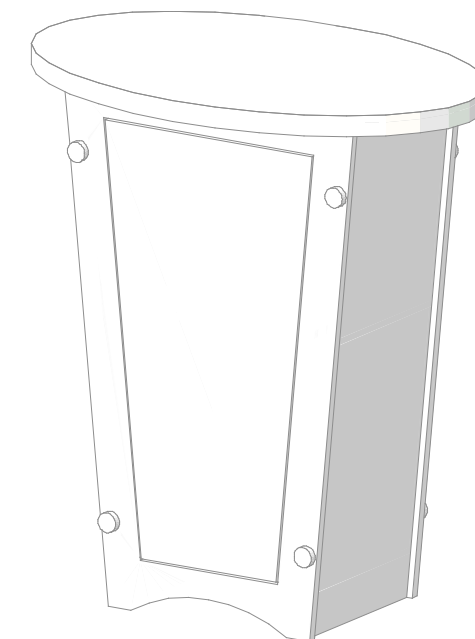
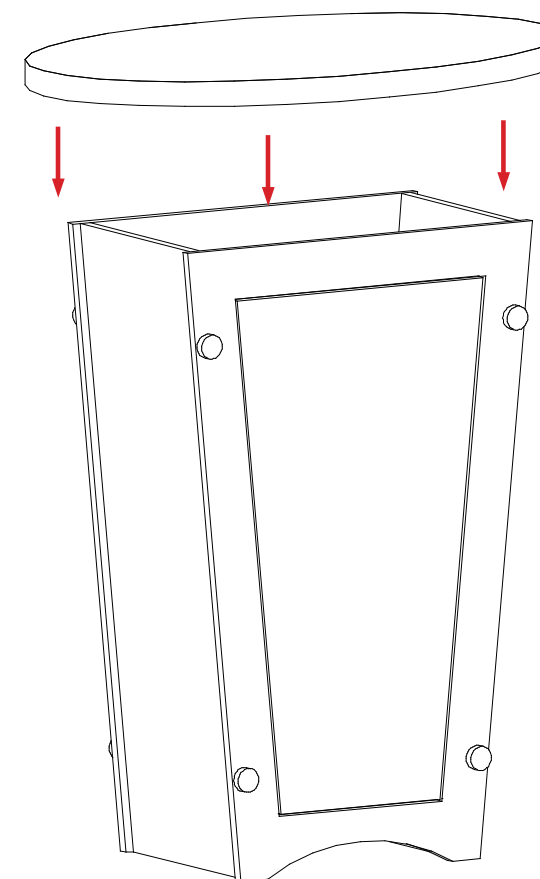

**WHEN DISASSEMBLING ALUMINUM EXTRUSION, TIGHTEN ALL SETSCREWS AND LOCKS TO PREVENT LOSS DURING SHIPPING**

### Top View

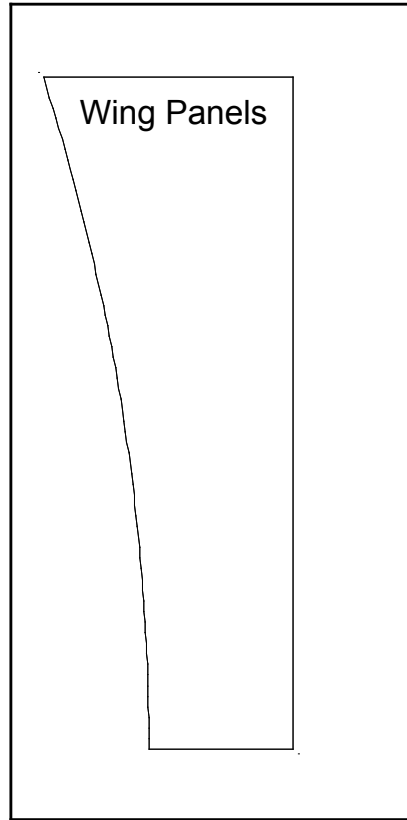

Level 1

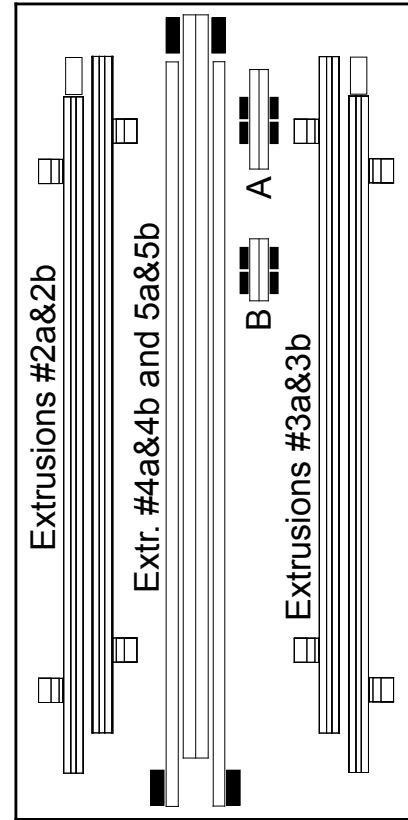

Level 2

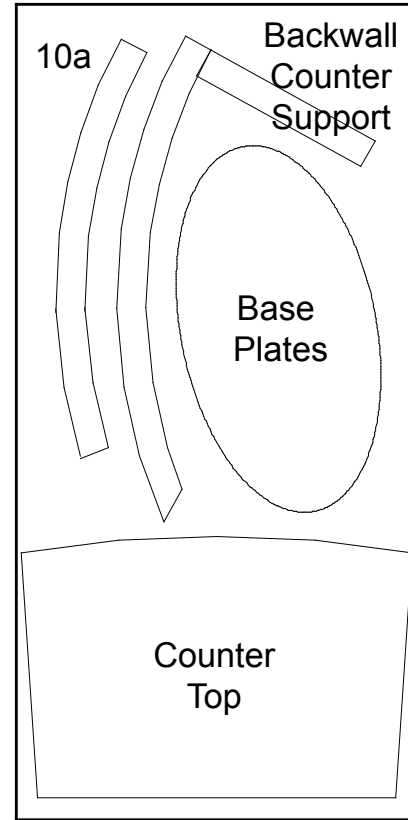

Level 3

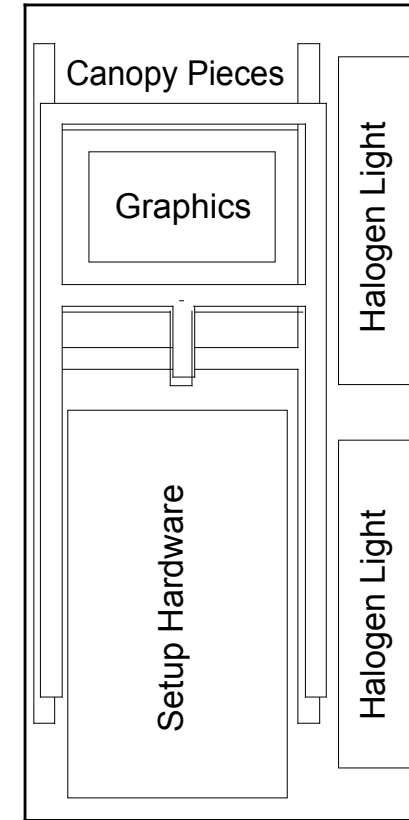

Level 4

WHEN DISASSEMBLING ALUMINUM EXTRUSION, TIGHTEN ALL SETSCREWS AND LOCKS TO PREVENT LOSS DURING SHIPPING

(2) Pedestal Components

Top View

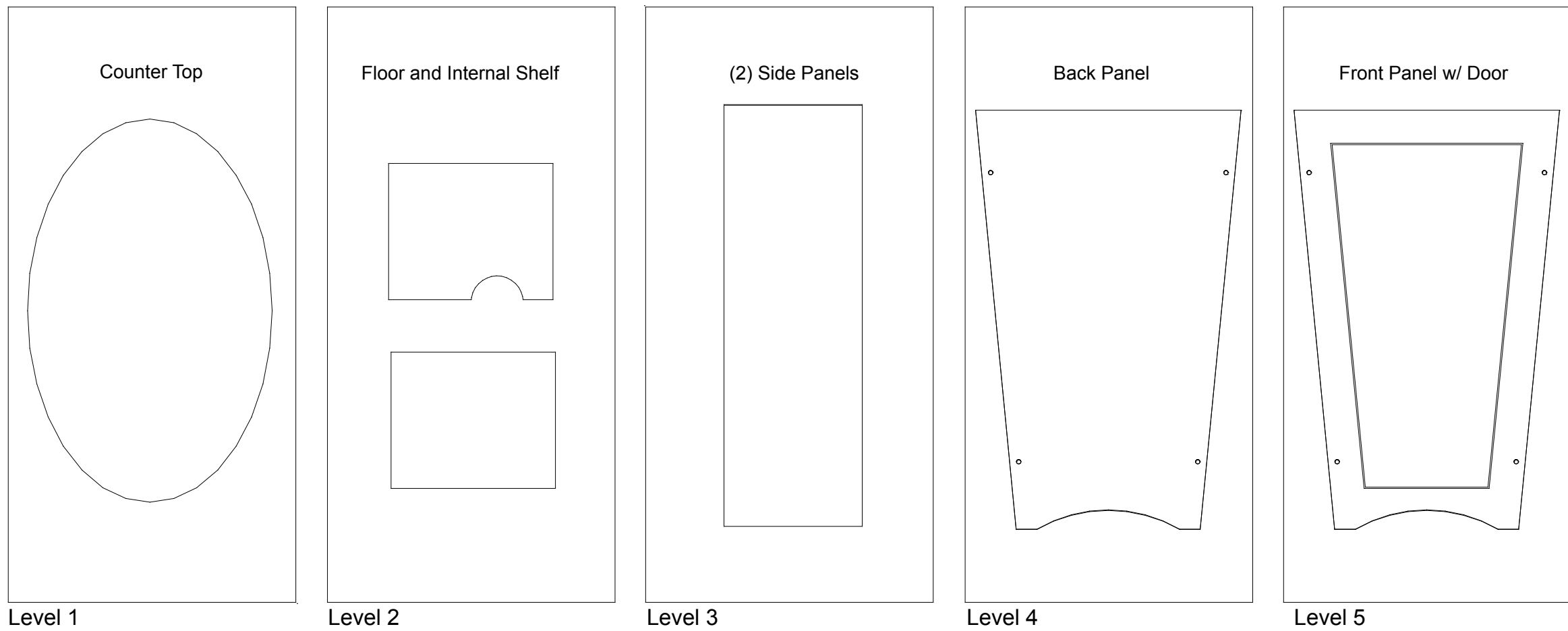

WHEN DISASSEMBLING ALUMINUM EXTRUSION, TIGHTEN ALL SETSCREWS AND LOCKS TO PREVENT LOSS DURING SHIPPING